



Secretariat of the Pacific Community

# Horizontal Longline Fishing Methods and Techniques

## A Manual for Fishermen

by

*Steve Beverly, Lindsay Chapman and William Sokimi*



All rights for commercial / for profit reproduction or translation, in any form, reserved. The SPC authorises the partial reproduction or translation of this material for scientific, educational or research purposes, provided that SPC and the source document are properly acknowledged. Permission to reproduce the document and/or translate in whole, in any form, whether for commercial / for profit or non-profit purposes, must be requested in writing. Original SPC artwork may not be altered or separately published without permission.

Original text: English

Secretariat of the Pacific Community  
BP D5  
98848 Noumea Cedex  
New Caledonia  
Tel: + 687 26.20.00  
Fax: + 687 26.38.18  
spc@spc.int  
www.spc.int

---

Secretariat of the Pacific Community Cataloguing-in-publication data

Beverly, Steve

Horizontal longline fishing methods and techniques: a manual for fishermen  
/ by Steve Beverly, Lindsay Chapman and William Sokimi

1. Longlining (Fisheries) – Oceania – Handbooks, manuals, etc.
2. Tuna fisheries – Oceania.
1. Title 2. Secretariat of the Pacific Community 3. Chapman, Lindsay
4. Sokimi, William

639.2099

AACR2

ISBN 982-203-937-9

---

Preparation of this manual was funded by the Australian Government and the New Zealand Government

Authors

1. Steve Beverly, Fisheries Development Officer, Secretariat of the Pacific Community, BP D5, 98848 Noumea Cedex, New Caledonia
2. Lindsay Chapman, Fisheries Development Adviser, Secretariat of the Pacific Community, BP D5, 98848 Noumea Cedex, New Caledonia
3. William Sokimi, Fisheries Development Officer, Secretariat of the Pacific Community, BP D5, 98848 Noumea Cedex, New Caledonia

Prepared for publication at  
Secretariat of the Pacific Community, Noumea, New Caledonia  
and printed by  
Multipress, Noumea, New Caledonia

---

## ACKNOWLEDGEMENTS

The Secretariat acknowledges contributions from the following people: from SPC — Mr Juan-Jose Areso, Mr Keith Bigelow, Ms Deirdre Brogan, Mr Aymeric Desurmont, Mr Sifa Fukofuka, Mr Jean-Paul Gaudechoux, Dr John Hampton, Ms Lyn Lambeth, Mr Tim Lawson, Dr Patrick Lehodey, Ms Marie-Ange Roberts, Mr Peter Sharples, Mr Wade Whitelaw and Mr Peter Williams; from Hawaii — Mr Scotty Barrows, Mr Paul Bartram, Mr Jeff Broad, Mr Ray Clarke, Mr Jim Cook, Mr David Itano, Mr Mike Madden, Mr Sean Martin, Mr Mike McCoy, Mr John Myking, Mr Joseph O'Malley, Mr Smokey Oshiro and Mr Allan 'Samson' Willingham; from Fiji Islands — Mr Ian Chute, Mr Grahame Southwick and Mr Dave Lucas; from PNG — Mr Rusty Strickland; from Tonga — Mr Bill Holden; from New Caledonia — Mr Vincent Puluiueva; from Tahiti — Mr Gilles Leboucher and Mr Coco Chung Shing; from Pohnpei — Mr Gerry Russo; and from Australia — Mr Ian Cartwright.

The authors acknowledge the contributions of Ms Youngmi Choi for the production of many of the diagrams used in this manual, and for the formatting and laying out of the manual, Ms Patricia Martin for the design of the cover, and Ms Maureen Wright for editing the text.

## UNITS AND CONVERSIONS

For the most part, metric units are used in this manual. Fathoms and nautical miles are often referred to, as many fishermen prefer fathoms to metres and nautical miles to kilometres. Conversion between metric and Imperial or US units is as follows:

1 mm = 0.039 in	1 km = 0.62 nm	1 oz = 28.3 g
1 cm = 0.393 in	1 nm = 1.85 km	1 kg = 2.2 lb
1 m = 3.281 ft	1 l = 0.22 Imperial gallons	1 mt = 2200 lb
1 m = 0.546 fa	1 l = 0.26 US gallons	1 short ton = 2000 lb
1 in = 25.38 mm	1 kt = 1.8 km/h	1 PSI = 6.895 kPa
1 in = 2.54 cm	1 kt = 31 m/min	1 PSI = 0.070 kg/cm <sup>2</sup>
1 ft = 0.305 m	1 kW = 1.34 HP	1 bar = 14.5 PSI
1 fa = 6 ft	1 HP = 0.74 kW	1 GPM = 4 l/m
1 fa = 1.83 m	1 g = 0.03 oz	

### Circumference of a circle

The formula for finding the circumference of a circle is: Circumference = Diameter x  $\pi$ .  
 $\pi = 3.14$  for practical purposes.

### Speed, distance, and time

The formulas for speed, distance, and time are: Speed = Distance/Time or Distance = Speed x Time or Time = Distance/Speed.

### Temperature

To convert °F to °C subtract 32, multiply by 5 and divide by 9  
To convert °C to °F multiply by 9, divide by 5, and add 32

## DISCLAIMER

For convenience, when referring to specific tasks and who does them in this manual, the male gender is used. Any reference to members of the crew or their jobs, however, may be interpreted as meaning both male and female. Thus, 'fisherman' means anyone, man or woman, who fishes; and the pronoun 'he' means 'he or she'. The use of the generic term 'fisher' has been avoided and the use of the awkward pronoun 'he/she' has been avoided. Reference or mention of specific commercial products or brand names should not be interpreted as an endorsement by the SPC.

---

# CONTENTS

	Page
ABBREVIATIONS AND ACRONYMS	vii
INTRODUCTION	1
CHAPTER 1: BASIC INFORMATION AND TECHNIQUES	3
A. What is horizontal longlining?	4
B. The western and central Pacific Ocean tuna longline fishery	6
C. The catch: target species	8
D. The catch: byproduct and bycatch species	10
E. Bait used in longline fishing	12
F. Handling, preparing and splicing ropes and lines	14
G. General knots	16
H. Knots used with monofilament and the use of crimps	18
I. Working with ropes and lines	20
J. Longline boats	22
K. Sea safety appliances and equipment	24
L. Sea safety and the rules of the road	26
CHAPTER 2: FISHING GEAR AND EQUIPMENT	29
A. The longline: basic gear configuration and storage	30
B. Hydraulically powered machinery used with longline gear	32
C. Mainline and branchline materials and connection points	34
D. Branchline hardware	36
E. Making up branchlines	38
F. Floats, flagpoles and floatlines	40
G. Radio buoys	42
H. Vessel electronics	44
I. Vessel hydraulics	48
CHAPTER 3: FISHING OPERATIONS	51
A. Preparing for a fishing trip	52
B. Deciding where to fish: when leaving port	54
C. Deciding where to fish: when arriving at the fishing ground	56
D. Deciding where to fish: during the trip	58
E. Targeting the gear: the surface layer and the thermocline	60
F. Targeting the gear: depth of set	62
G. Setting and hauling the gear: general	65
H. Setting monofilament gear	66
I. Setting rope gear, setting time, data recording and soak time	68
J. Some variations on setting	70
K. Finding the gear	72
L. Hauling basket gear	73
M. Hauling monofilament gear	74
N. Encountering problems when hauling the gear	76
O. Fish on the line	78

---

CHAPTER 4: HANDLING AND PRESERVING THE CATCH	79
A. The basics and the tools needed	80
B. Landing, killing and bleeding the catch	82
C. Dressing sashimi tuna ready for chilling	84
D. Dressing swordfish ready for chilling	85
E. Dressing and loining albacore ready for freezing	86
F. Onboard preservation: icing the catch	88
G. Onboard preservation: CSW and RSW	90
H. Onboard preservation: freezing	91
I. Cleaning and sanitising	92
CHAPTER 5: MARKETING AND BUSINESS OPERATIONS	93
A. Marketing and grading in general	94
B. Packing fresh fish for export	96
C. Shipping and marketing export fish	97
D. Running a longline boat as a business	98
E. Fixed costs and the boat's accounts	100
CHAPTER 6: RESPONSIBLE FISHING	103
A. Marine debris and derelict fishing gear	104
B. Bycatch from tuna longlining	106
C. Releasing hooked turtles alive	108
D. Avoiding seabirds and bait loss	109
E. Depredation by toothed whales	110
F. Recording catch and effort data	111
G. Recording and reporting tagged species	112
H. Observers and port samplers	113
CONCLUDING REMARKS	114
APPENDICES	115
A. Weather conditions and sea state	117
B. Important radio frequencies and the phonetic alphabet	119
C. Glossary of nautical terms	121
D. Main species caught on a horizontal longline in the Pacific	125
E. Sample pre-departure checklist	127
F. South Pacific Regional Longline Logsheet and instructions	129

---

## ABBREVIATIONS AND ACRONYMS

$\pi$	pi
ADCP	acoustic doppler current profiler
ALC	automatic location communicator
BTG	bathythermograph
BTS	burnt tuna syndrome
°C	degrees centigrade
CIF	cost, insurance, freight
cm	centimetre
CO <sub>2</sub>	carbon dioxide
COLREGS	International Regulations for Preventing Collisions at Sea
Cospas-Sarsat	Cosmicheskaya Sistyema Poiska Avarinich Sudov – Search and Rescue Satellite Aided Tracking, a cooperative search and rescue satellite system operated by USA and Russia
CPR	cardio-pulmonary resuscitation
CPUE	catch per unit effort
CSIRO	Commonwealth Scientific and Industrial Research Organisation (Australia)
CSW	chilled seawater
dia	diameter
DSC	digital selective calling
DSL	deep scattering layer
DWFN	distant water fishing nation
EEZ	exclusive economic zone
EPIRB	emergency position indicating radio beacon, linked to Cospas-Sarsat
ETA	estimated time of arrival
etc.	et cetera
ETD	estimated time of departure
EU	European Union
°F	degrees Fahrenheit
fa	fathom
FFA	Forum Fisheries Agency
ft	foot
FAD	fish aggregating device
FAO	Food and Agriculture Organization of the United Nations
FOB	free on board
G&G	gilled and gutted
GMDSS	Global Maritime Distress and Safety System
GMT	Greenwich mean time (also called universal time coordinated — UTC)
GPM	gallons per minute
GPS	global positioning system
g	gram
GRT	gross registered tons
GT	gross tons
HACCP	hazard analysis and critical control point system
H&G	headed and gutted
HF	high frequency (radio)
HP	horsepower
h	hour
IALA	International Association of Lighthouse Authorities
IDO	industrial diesel oil
IMO	International Maritime Organization
in	inch

---

Inmarsat	International Maritime Satellite Organization
Inmarsat-C	a two-way data messaging system based on digital technology that enables users to transmit and receive telex and fax messages to and from ships and land stations via satellite; does not provide voice communications; it is the system most often used in VMS systems
IRD	Institut de Recherche Pour le Développement (formerly ORSTOM)
ITU	International Telecommunications Union
JFIC	Japan Fishery Information Service Center
JV	joint venture
kg	kilogram
kHz	kilohertz
km	kilometre
kt	knot (nautical miles per hour)
kPa	kilopascal
l	litre
lat	latitude
lb	pound
LC	letter of credit
LCD	liquid crystal display
LES	land earth station
long	longitude
LPG	liquid propane gas
m	metre
mb	millibar (also hectopascal)
°M	magnetic course
mHz	megahertz
mm	millimetre
mono	monofilament
mph	miles per hour
mt	metric tonne
nm	nautical mile
NIWA	National Institute of Water and Atmospheric Research (New Zealand)
NOAA	National Oceanographic and Atmospheric Administration (USA)
NT	net tons
oz	ounce
PC	personal computer
PFD	personal flotation device
PICTs	Pacific Island countries and territories
PSI	pounds per square inch
PTO	power take-off
RCC	rescue coordination centre
RDF	radio direction finder
RPM	revolutions per minute
RSW	refrigerated seawater
R-22	one type of Freon
SAR	search and rescue
SART	search and rescue transponder
sec	second
SOLAS	Safety of Life at Sea Convention
SPC	Secretariat of the Pacific Community
SR	sagging rate
SSB	single sideband (radio)
SST	sea surface temperature
°T	true course

---

---

TDR	temperature–depth recorders
TT	telex (or telegraphic) transfer
UHT	ultra heat treated
ULT	ultra-low temperature
UNCLOS	United Nations Convention on Law of the Sea
USA	United States of America
UTC	universal time coordinated (also called Z or Zulu time or Greenwich mean time — GMT)
VHF	very high frequency (radio)
VMS	vessel monitoring system
WCPO	western and central Pacific Ocean
XBT	expendable bathythermograph



---

## INTRODUCTION

The Secretariat of the Pacific Community has been active in promoting fisheries development in Pacific Island countries and territories for over 30 years. A particular area of strength has been SPC's programme of training in fishing and boat-handling techniques for small- and medium-scale fishermen. This programme, initiated in 1978, has been carried out by SPC's team of Fisheries Development Officers (formerly called Masterfishermen), who, at the request of Pacific Island governments, conduct training courses, visit fishing communities and work with private sector companies to carry out practical fishery demonstration activities. The information contained in this manual has been compiled from the discussions and written records of the SPC Fisheries Development Officers and other fisheries development staff. In fact, part of the reason for compiling the manual was in order to capture, at least partially, the largely unwritten specialist knowledge and practical experience accumulated by SPC's fishing staff during their commercial activities before working for SPC and during their field activities with SPC.

The main purpose of the manual, however, is to introduce the horizontal longline fishing method to Pacific Island fishermen, as well as to assist those currently involved to improve their fishing success, particularly in commercial or semi-commercial situations. The manual is intended to act as a guide to the principles and techniques of good horizontal tuna longline fishing, for use by fishermen who want to start, refine or broaden their skills. We have tried to give as much detail as possible on the rigging and use of monofilament longline fishing gear, and to provide brief descriptions of rope gear and other possible variations to these gears and the fishing methods. We have included information on fish handling practices which will lead to top prices for fish sold on both local and export markets. Environmental and conservation issues and concerns have also been included to raise awareness and to present ways to minimise impacts on unwanted species or the environment as a result of horizontal tuna longline fishing activities.

A further aim of the manual is to serve as a resource in formal training activities carried out by the SPC fisheries programme as well as national fisheries development agencies and extension officers. The manual is intended for use as a training aid to help introduce and explain fishing topics to small- and medium-scale fishermen and others. To support this aim, we have tried to present as much information as possible in a visual form, for the benefit of the many Pacific fishermen whose first language is not English. For the same reason, the text has been kept as simple and non-technical as possible.

In compiling this manual, we have split the many interwoven aspects of horizontal tuna longline fishing into topics, organised into six main chapters, which deal with tuna longline basics, preparation of the fishing gear and equipment, fishing operations and procedures, handling and preserving the catch, marketing and business operations, and responsible fishing practices. This is followed by several appendices. Appendix A provides useful information and tips on weather conditions and sea state, Appendix B provides important radio frequencies and the phonetic alphabet, and Appendix C provides a glossary of nautical terms. Predictably, it has proven impossible to avoid overlap altogether. However, we hope that the cross-references in the text, together with the detailed topic headings and sub-headings presented in the contents list, will enable readers to follow a given theme in the text, or to find the specific information they seek.

SPC has produced a number of other manuals, handbooks and training materials on fishing and related topics. *Trolling Techniques for the Pacific Islands: A Manual for Fishermen* provides complete information on trolling methods and gear. The two manuals, *Vertical Longlining and Other Methods of Fishing Around Fish Aggregation Devices* and *Deep-bottom Fishing Techniques for the Pacific Islands* explain the techniques involved in these types of fishing. The three volumes of the SPC FAD Handbook are aimed at helping fisheries departments to establish FAD programmes that will provide maximum benefits for the local fishing industry. Various other SPC training and public information materials (including lecture notes, videos, overheads, brochures and posters) on fishing, FADs, environmental concerns, and safety at sea are also available, as are construction diagrams and specifications for the FAO wooden fishing handreels. For more information write to SPC or visit the SPC's website on <http://www.spc.int/coastfish>.

# CHAPTER 1

## BASIC INFORMATION AND TECHNIQUES

- A. What is horizontal longlining?
- B. The western and central Pacific Ocean tuna longline fishery
- C. The catch: target species
- D. The catch: byproduct and bycatch species
- E. Bait used in longline fishing
- F. Handling, preparing and splicing ropes and lines
- G. General knots
- H. Knots used with monofilament and the use of crimps
- I. Working with ropes and lines
- J. Longline boats
- K. Sea safety appliances and equipment
- L. Sea safety and the rules of the road

### INTRODUCTION

This chapter provides information on the origin and history of horizontal tuna longlining, the latest science, and the current importance of this fishing method to developing domestic tuna longline fisheries in the Pacific region. The main target, byproduct and bycatch species are examined, looking at the habits that fishermen can use to their advantage in locating them and the baits that can be used. Knots and splices suitable for making up the different components of gear are described, as well as the use of ropes and lines for both fishing activities and general boat handling. It also briefly looks at the different types of tuna longline vessels used in the region, for small-, medium- and large-scale operations. Finally, sea safety and the relevant rules of the road are covered to emphasise the importance of taking precautions and being prepared, as tuna longlining can be a hazardous occupation if not conducted in a safe and professional manner.

## A. WHAT IS HORIZONTAL LONGLINING?

Horizontal longline fishing uses a long mainline made of tarred rope or nylon monofilament to which are attached hundreds or thousands of branchlines, each with a single baited hook. The mainline can be from 5 to 100 nm long. The line is suspended in the water by floatlines attached to floats, which may have flagpoles, lights, or radio beacons. Longlines are usually set and hauled once daily and are allowed to drift freely, or soak, for several hours while fishing. Longlines are set, either by hand or mechanically, while the boat steams away from the line and are usually hauled mechanically while the boat steams toward the line. The species targeted are tunas and some billfish.

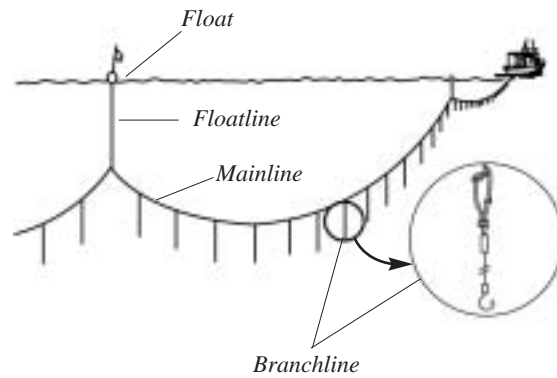

### A bit of history

Horizontal longline fishing for pelagic species evolved in Japan during the nineteenth and early twentieth centuries. Sailboats equipped with hemp longlines would venture as far as 30 nm offshore from Japan in search of tuna and billfish. By 1912 there were over 100 registered sailboat tuna longliners in Japan. The first diesel powered steel longline vessels did not appear until the early 1920s. The longlines were hauled by hand until 1929 when the first mechanical Izui line hauler was developed.



Longline fishing was introduced to the rest of the Pacific Ocean in the 1930s by Japanese fishermen. By 1939 there were about 70 Japanese longline boats of between 60 and 270 gross registered tons (GRT) operating in the western and central Pacific Ocean from bases in Palau, Chuuk, and the Northern Marianas. At about the same time descendants of Japanese immigrants in Hawaii introduced what was called 'flagline fishing' to local fishermen. It was called flagline fishing because the mainline was marked by a series of flags on bamboo poles supported by glass floats.



During World War II (1941 to 1945) fishing activities were curtailed in the Pacific Ocean, but after the war they resumed again when restrictions to vessel movements were lifted. By the early 1950s, after abolition of the MacArthur Line (this was the name for the occupation force's blockade which was set at 24°N and 165°E in 1946), there were close to 100 Japanese longliners operating in the western and central Pacific Ocean. Several fish bases were established throughout the Pacific to service the longline and pole and line vessels.

In the 1960s there were over 200 Japanese longliners operating throughout the Pacific: boats of 30 to 100 GRT in the Trust Territories, or Micronesia, boats of 100 to 200 GRT operating further east, and boats up to 400 GRT operating as far east as French Polynesia. Until the late 1960s most of these longliners were targeting albacore for the canneries and the catch was frozen at sea. In the early 1970s the Japanese longline fishery switched to more equatorial tunas and began fishing for sashimi grade bigeye and yellowfin tunas. Korean and Taiwanese boats soon began to replace the Japanese boats in the longline albacore fishery. The combined Korean and Taiwanese fleet numbered in the hundreds of boats and operated in Samoa, Vanuatu and Fiji Islands. In the late 1970s these boats also began switching to the sashimi tuna fishery.

1980 was the peak year for fishing for the Asian fleet operating in the western and central Pacific Ocean — 4647 boats landed 208,696 mt of bigeye, yellowfin, albacore, and skipjack tuna. By 1997 there were more longliners (4886) operating in the western and central Pacific Ocean, but fish landings totalled only 179,535 mt.

In Hawaii the domestic longline fleet stayed relatively small until the late 1980s when it expanded substantially. In 1983 the fleet consisted of around 40, mostly older wooden Japanese-style ‘sampans’ with traditional flagline gear. By 1990 the fleet had grown to 140 mostly steel and fibreglass boats in the 50 to 100 GRT range equipped with modern monofilament longline gear and sophisticated electronics. The fishery also changed. Many boats began fishing for broadbill swordfish. The advent of monofilament longline systems revolutionised the fishery by offering a simpler, more compact, more economical, less labour intensive, but more efficient system of catching pelagic species. The Hawaiian longline fishery was the precursor to the development of domestic longline fisheries in the rest of the Pacific Ocean, including Fiji Islands, Tahiti, Australia and New Zealand.

The 1978 UNCLOS (United Nations Convention on the Law of the Sea) allowed Pacific Island countries and territories (PICTs) to declare 200 nm exclusive economic zones (EEZs), and to take control over the marine resources within their EEZs. Starting in the early 1980s the Japanese, Korean and Taiwanese vessels fishing in the Pacific Ocean were required to secure permits and to pay access fees to fish within the many Pacific Island EEZs. On average, the fees received from foreign vessels amount to around five per cent of the market value of the fish caught. Starting in the late 1980s there has been a trend for PICTs to attempt to replace the foreign fleets with domestic fleets. With domestically based vessels, the financial return to the country can be much higher. Much of the revenue earned from longline fishing is in foreign currency as the main markets for fresh sashimi tuna are in Japan and the USA. Longline fishing can therefore become a very important component of Pacific Island economies.

Some PICTs have developed domestically owned fleets while others have entered into joint ventures with foreign fishing companies. Joint venture operations usually involve two separate companies operating together under a third company. Other PICTs have attempted to start up domestic longline fishing using government owned and operated vessels, while others have a combination of foreign vessels, locally owned domestic vessels, and foreign owned but domestically based joint venture vessels.

Of all the SPC member countries and territories, Fiji Islands, French Polynesia, New Caledonia, Papua New Guinea, Samoa, Tonga and American Samoa have been the most successful in developing domestic longline fishing to date, while others are struggling to enter this fishery.

The Oceanic Fisheries Programme at SPC is the repository for all catch and effort data on the western and central Pacific Ocean tuna fishery. With this data, the Programme makes a regional stock assessment of the resource, and this information forms the basis for management of the tuna resource in the region



*EEZs of SPC members*

## B. THE WESTERN AND CENTRAL PACIFIC OCEAN TUNA LONGLINE FISHERY

The longline fishery typically accounts for around 10 to 12 per cent of the total western and central Pacific Ocean (WCPO) tuna catch, but rivals the much larger purse seine catch in landed value. The longline fishery provides the longest time series of catch estimates for the WCPO, with estimates available since the early 1950s.

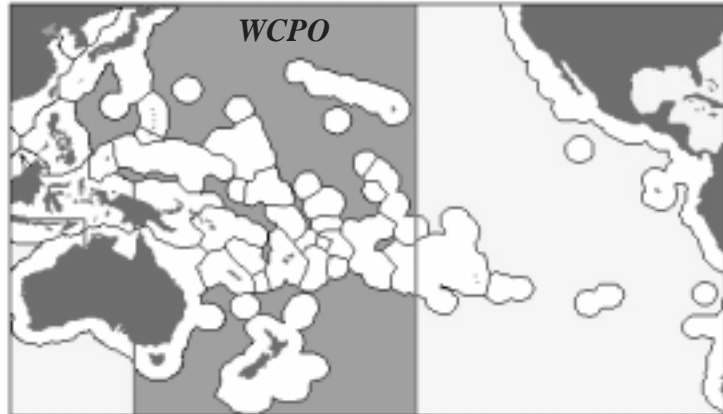

Pacific Ocean showing the WCPO area

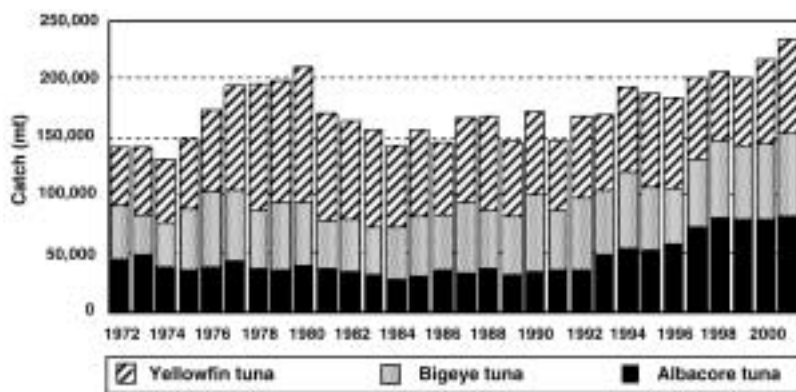

Longline catch (mt) of tunas in the WCPO

The annual total longline tuna catch has been relatively stable during the past 25 years, with total catches generally between 130,000 and 200,000 mt and comprising almost entirely yellowfin, bigeye and albacore tuna. Catches in recent years have been at record levels, but the species composition (35% albacore, 35% yellowfin and 30% bigeye tuna in recent years) has changed significantly from the 1970s (18% albacore, 57% yellowfin and 25% bigeye tuna in 1980), as a result of changes in fleets, operational areas and targeting practices.

The majority of the yellowfin tuna catch tends to be taken in tropical areas, especially in the western parts of the region, with smaller amounts in seasonal subtropical fisheries. The majority of the bigeye tuna catch is taken from tropical areas, but in contrast to yellowfin, mainly in the eastern parts of the WCPO adjacent to the traditional eastern Pacific Ocean bigeye tuna fishing grounds. The albacore tuna catch is taken in subtropical and temperate waters in both hemispheres.

There have been significant changes in fleet operations during the past two decades. For example, a feature of the 1980s was a change in targeting practices (fishing deeper to catch bigeye in cooler waters) in order to capitalise on a higher price for bigeye compared to yellowfin tuna. The entrance into the fishery and subsequent decline of the smaller offshore sashimi longliners of Taiwan and mainland China, based in Micronesia during the past decade, was also noteworthy. There has also been a trend towards flexibility in species targeting in some fleets, notably those with ultra-low temperature freezing capacity. In recent years, large Chinese longliners have been targeting albacore in the high seas areas of the south Pacific, and there has been rapid development of the longline fishery in at least one southeast Asian country (Vietnam).

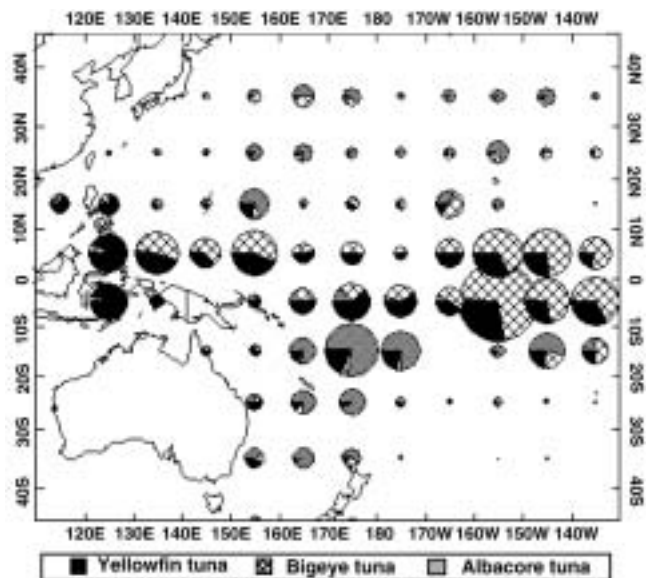

Distribution of the longline tuna catch by species during 2000

The tuna longline fishery involves two main types of operation:

- large (typically >250 GRT) distant water fishing nation (DWFN) freezer vessels which undertake long voyages of several months and operate over large areas of the region;
- smaller (typically <100 GRT) offshore vessels, usually domestically based, with ice or chill capacity, and serving fresh or airfreight sashimi markets, which operate mostly in tropical areas.

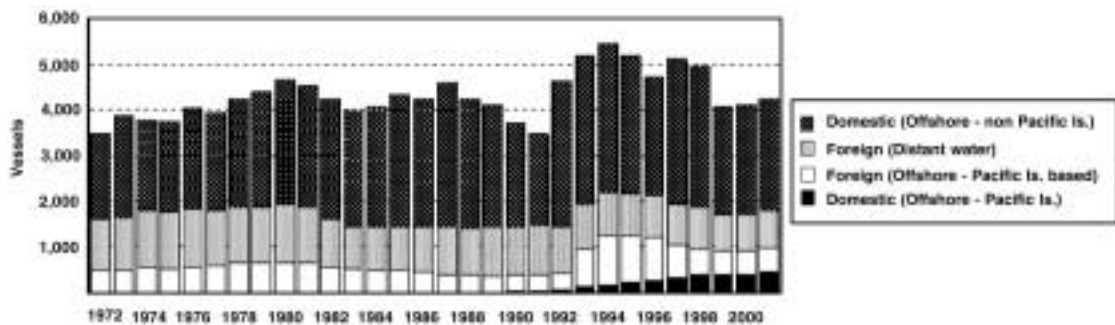

*Longline vessel numbers operating in the WCPO*

### DWFN fleets

Up to now, most of the WCPO longline catch has been taken by the large vessel DWFN fleets of Japan, Korea and Taiwan, although their proportion of the catch has declined in recent years. Some DWFN vessels operate in tropical waters targeting bigeye and yellowfin tuna for the frozen sashimi market, and others operate in the more temperate waters targeting albacore for canning. Some voluntary reduction by the Japanese distant water fleet has occurred in recent years.

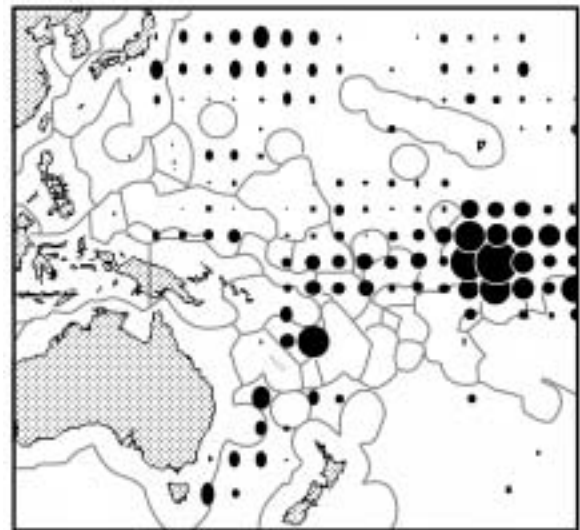

*Distribution of DWFN longline effort during 2000*

### Offshore fleets

In recent years, there has been a gradual increase in the number of PICT domestic vessels, such as those from American Samoa, Samoa, Fiji Islands, French

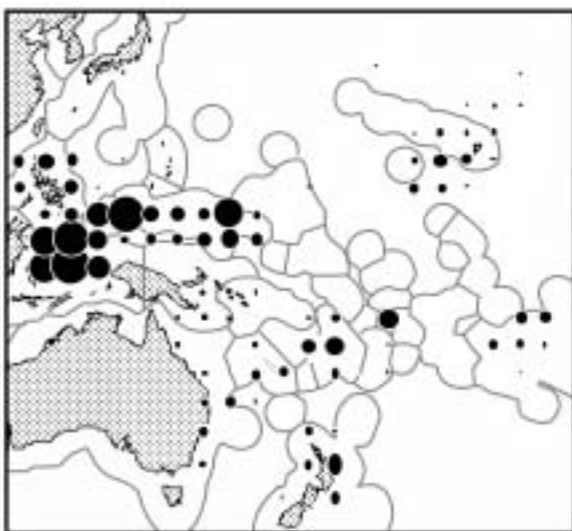

*Distribution of the offshore fleet effort (excludes Japanese coastal fishery) during 2000*

Polynesia, New Caledonia, Solomon Islands and Tonga. These fleets mainly operate in subtropical waters, with albacore the main species taken. These fleets now take over 10 per cent of the total WCPO catch, and close to 50 per cent of the south Pacific albacore catch. The most significant developments over the past five years have been the growth of the Fijian fleet and the establishment of the domestic Samoan and French Polynesian fleets.

Domestic fleet sizes are increasing at the expense of foreign offshore and distant water fleets. There are now over 400 Pacific Island domestic vessels operating in the WCPO region. Activity by the offshore fleets from Japan, mainland China and Taiwan is restricted to tropical waters, targeting bigeye and yellowfin tuna for the fresh sashimi market; these fleets have limited overlap with the DWFN fleets. The substantial offshore effort in the west of the region is primarily by Indonesian and Taiwanese domestic fleets targeting yellowfin and bigeye tuna.

## C. THE CATCH: TARGET SPECIES

The main target species of pelagic longline fishing are tunas and billfish, while other species including sharks can also be an important component of the catch. Appendix D provides a list of the main species caught on longlines, with the English, French, Japanese and scientific names. The catch can be divided into three distinct categories: target, byproduct and bycatch.

Tunas are by far the most important target species for horizontal longlining. The highest value species are bluefin tuna — which are not often caught in Pacific Island EEZs — followed by bigeye tuna, yellowfin tuna, and albacore tuna, in that order. Some billfish are also targeted, with broadbill swordfish being the most important, followed by striped marlin. Table 1 outlines the main parameters for locating and catching these target species. (Note: these general parameters will vary with hemisphere, locality, season, moon phase, and local conditions.)

**Table 1: Main parameters for locating and catching target species**

Species	Capture depth	Temp. range	Best baits	Season	Set/haul times
bigeye tuna	50 – 600 m, thermocline	10 – 17°C	sauy, bigeye scad, pilchard, squid	winter	0400 – 0800 / 1400 – 1800
yellowfin tuna	50 – 250 m, mixed and intermediate layer	18 – 28°C	sauy, bigeye scad, milkfish, squid	summer	0400 – 0800 / 1400 – 1800
albacore tuna	50 – 600 m, thermocline	10 – 17°C	sauy, pilchard, sardine	late summer, autumn, early winter	0400 – 0800 / 1400 – 1800
broadbill swordfish	50 – 150 m, mixed and intermediate layer	18 – 22°C	<i>Illex</i> spp. squid, lightsticks	late winter and spring	1800 – 2000 / 0600 – 0800
striped marlin	50 – 250 m, mixed and intermediate layer	20 – 23°C	sauy, bigeye scad, milkfish, squid	late winter and spring	0400 – 0800 / 1400 – 1800

**Bigeye tuna:** are the most valuable species caught in the Pacific and are found throughout the tropical and temperate Pacific Ocean. Fishermen targeting bigeye tuna set their lines deep because bigeye are often associated with the thermocline (Chapter 3 E), which is found between 100 and 350 m, depending on the area and time of year. Scientists have recorded this species going as deep as 660 m in some locations. Bigeye tuna catches are best between the 10° and 17°C isotherms (Chapter 3 B) in the water column, although they can be caught at higher temperatures nearer the surface.

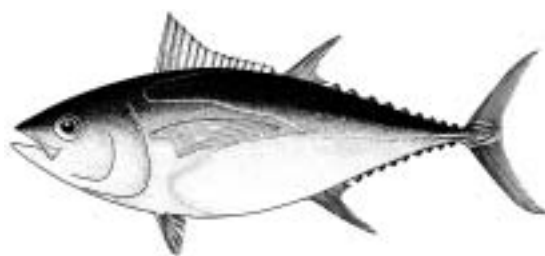

Bigeye tuna can be caught all year round in equatorial waters but are more seasonal in higher latitudes. The best bigeye catches are usually in the winter months. Large bigeye come close to the surface to feed at night in equatorial waters and can be caught a few days before, during, and a few days after a full moon. These full moon sets are shallow, down to about 50 to 100 m using squid for bait, and are made in the evening and hauled the following morning. Otherwise, bigeye sets are generally made in the morning and hauled in the afternoon and evening. The most marketable bigeye tuna are those weighing 40 kg or more. Bigeye tuna are usually marketed as fresh chilled fish for sashimi.

**Yellowfin tuna:** are also found throughout the tropical and temperate Pacific Ocean, but the stock in the WCPO is different than the stock in the eastern Pacific Ocean. Although they can be caught in deeper water, longline caught yellowfin are usually taken in water from near the surface down to 250 m — above the thermocline. This layer of water is called the mixed and intermediate layer (Chapter 3 E). The preferred temperature range for yellowfin tuna is 18° to 28°C, which roughly corresponds to temperatures found in the mixed and intermediate layer.

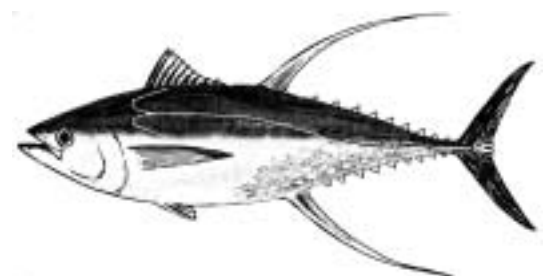

Fishermen targeting yellowfin often look for temperature fronts or breaks, upwellings, current convergences, eddies, seamounts, and flocks of feeding seabirds (Chapter 3 D). The best season for yellowfin tuna is in the spring and summer months. The most marketable yellowfin tuna are those that weigh 30 kg or more. Yellowfin are usually sold as fresh chilled fish for sashimi or to be used in cooking. Yellowfin is second to bigeye as a sashimi fish in quality and value.

**Albacore tuna:** distribution in the Pacific Ocean is quite different than bigeye or yellowfin distribution. There are separate stocks in the northern Pacific and southern Pacific that inhabit temperate waters. These fish are schooling fish and are caught seasonally, in the summer and autumn months, at the surface by troll boats, and are smaller than longline caught albacore. Larger fish are caught by longline in deep tropical and subtropical waters down to the depth of the thermocline. Depth and temperature ranges for longline caught albacore are similar to those for bigeye tuna.

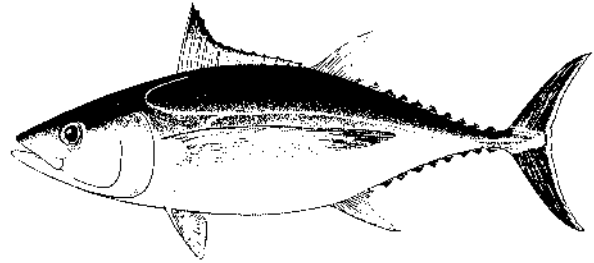

The season for longline albacore is not as apparent as for other tunas — autumn months in some locations, all year round with peaks in summer and in autumn and winter in other locations, and autumn and winter months in other areas. Longline caught albacore range from 15 to 20 kg and are sold frozen whole to canneries, fresh to export markets, or as frozen quarter-loins. Albacore, although traditionally more important for canning and cooking, is also becoming a popular fish for sashimi. There is currently a seasonal market for imported fresh fish in Japan during the months of July and August, and frozen albacore for sashimi is becoming increasingly popular in US and Japan markets.

**Broadbill swordfish:** are distributed throughout the tropical and temperate Pacific Ocean. They make daily excursions into deep water and return to the top of the mixed layer at night, where they can be caught on longlines baited with large squid and chemical light-sticks or electric lights (for attracting the swordfish to the baited hook). Swordfish are usually associated with seamounts or canyons or can be found near temperature fronts, current convergences, or eddies.

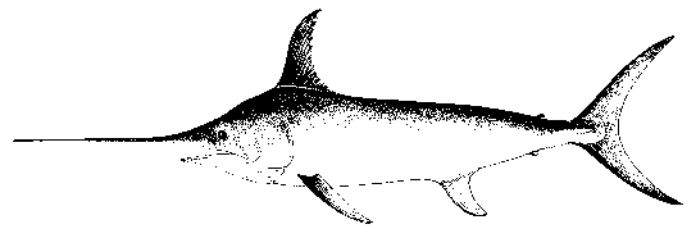

The preferred surface temperature range for swordfish is 18° to 22°C. Moon phases are important in swordfish longlining — fishing is best around the full moon. The best season for swordfish is in late winter and early spring. Swordfish are usually sold as fresh headed and gutted fish. Fish smaller than 23 kg dressed weight are called *rats*, fish between 23 and 45 kg are called *pups*, and fish over 45 kg are called *markers*. Markers are the most sought after fish in US markets. Pacific Island producers often have trouble getting their swordfish into US markets because of mercury content of the flesh, usually associated with larger fish.

**Striped marlin:** are found throughout the tropical and temperate Pacific Ocean. They are usually found in the upper mixed layer or near the surface. In fact, longline caught striped marlin are most often caught on the branchlines nearest the floats, the shallowest branchlines. They are not usually the main target species of longliners, but are caught in association with yellowfin tuna sets. The preferred surface temperature range for striped marlin is 20° to 23°C, although they can also be found in temperatures ranging from 15° to 26°C.

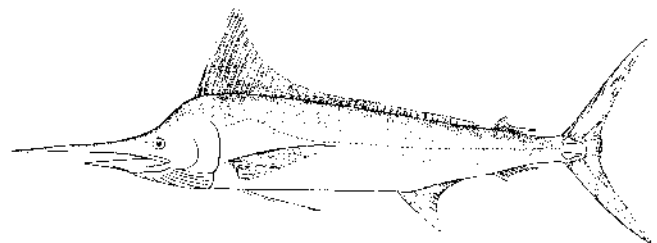

The usual size range of striped marlin is 60 to 120 kg, although specimens up to 190 kg have been caught. The seasons vary according to area. For example, in Hawaii and French Polynesia the best season is late winter and spring, while in New Caledonia the best season is spring and early summer. The flesh of striped marlin is popular as sashimi as it often has a pink colour, unlike the other marlin species, which have white or grey coloured flesh. Pacific caught striped marlin are exported to Japan as fresh fish seasonally.



## D. THE CATCH: BYPRODUCT AND BYCATCH SPECIES

**Byproduct:** are species that are caught incidentally (not targeted) during longline fishing, that have a commercial value and are retained for sale. These species include opah, black marlin, Indo-Pacific blue marlin, shortbill spearfish, sailfish, skipjack tuna, mahi mahi, wahoo, pomfret, escolar and barracuda, amongst others. A range of shark species are also taken as byproduct, although they are mainly prized for their fins (finning is probably going to be phased out as more and more countries are adopting a policy where the entire shark must be retained).

Black marlin, Indo-Pacific blue marlin, sailfish, skipjack tuna, mahi mahi and wahoo are distributed throughout the subtropical and tropical Pacific Ocean and are caught near the surface on the shallowest hooks in a set, near the floats. Conditions for catching these species are similar to conditions for catching yellowfin.

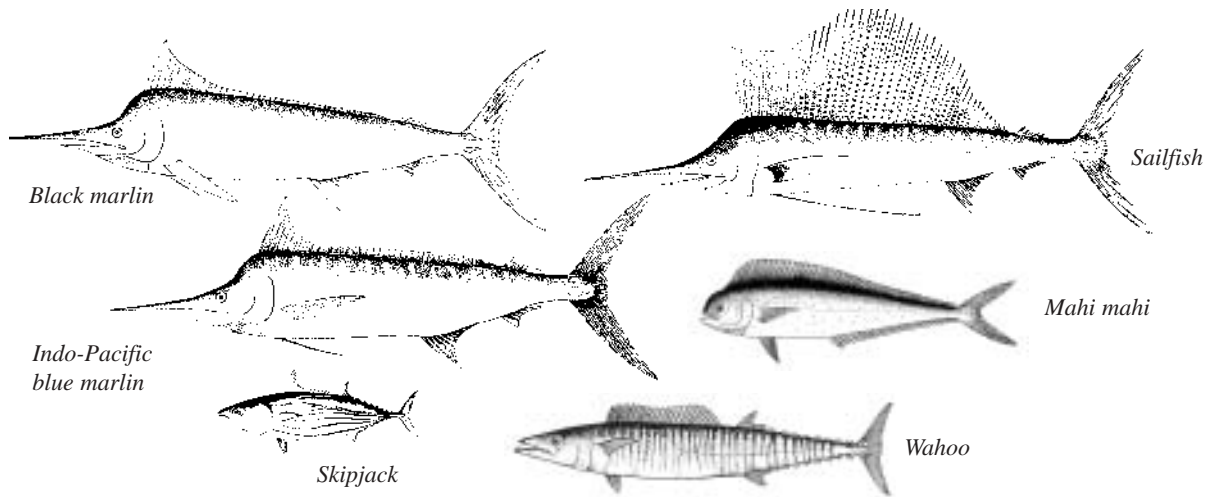

Byproduct species such as pomfret, escolar and opah are usually found in deeper waters and are associated with bigeye catches.

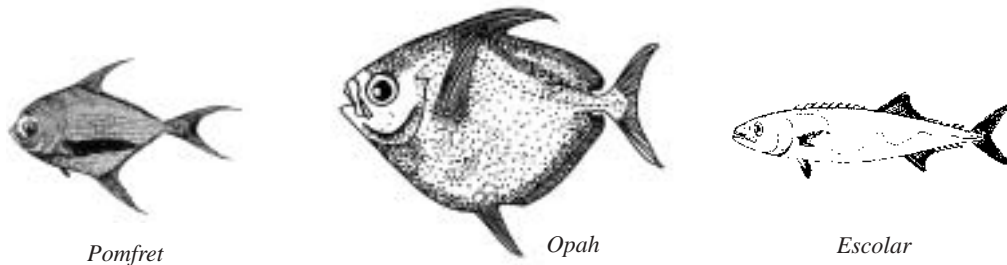

The most common species of shark taken by longlining include the blue shark, oceanic whitetip shark, short-finned mako shark, silky shark, thresher shark and tiger shark. These are all pelagic or oceanic sharks. Sharks are mainly caught on the shallower set hooks during normal tuna longlining activity. However, if sharks are specifically targeted, then sets are usually made at night and hauled in the morning.

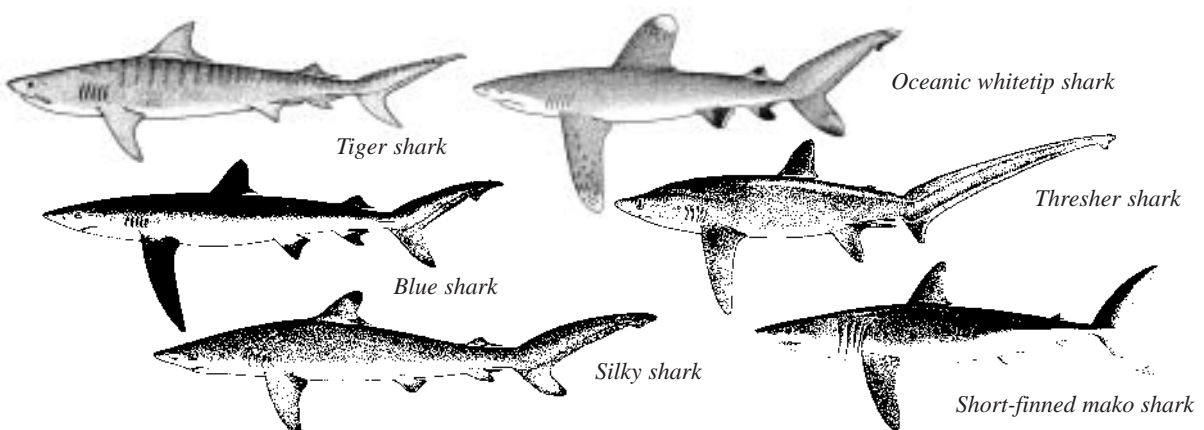

**Bycatch:** are the unwanted species that are taken incidentally during longlining, and are discarded as they have no commercial value. These species include snake mackerel, lancetfish, pelagic rays, seabirds and sea turtles, amongst others.

Snake mackerel, lancetfish and pelagic rays can be taken at various depths on a longline, and are not really associated with a particular type of longline set. The fish are generally small in size.

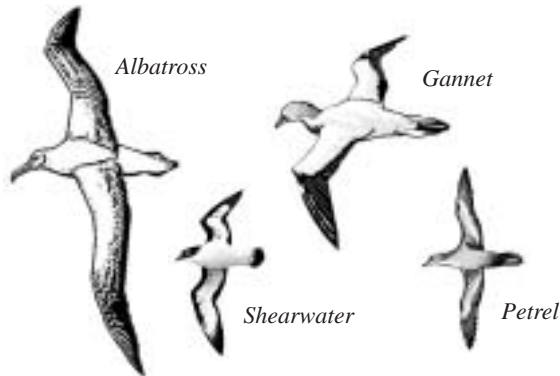
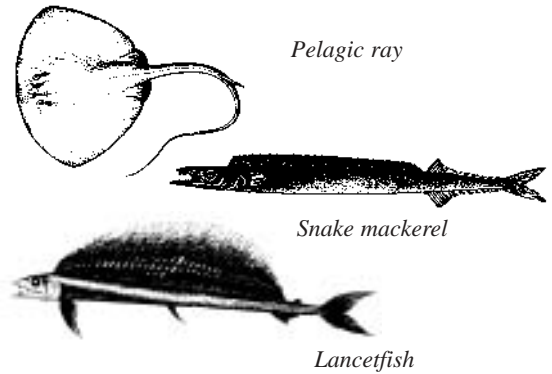

Seabirds, such as albatross, and sea turtles are sometimes caught on longlines. The seabirds attack the baits (Chapter 6 D) on the gear as it is being set, while the sea turtles are taken on the shallow hooks, generally near the floatline. The catch of seabirds and sea turtles by longliners has become an environmental issue in some localities as the animals are protected. This is an area of concern to all longline fishermen, and is discussed more in Chapter 6 B.

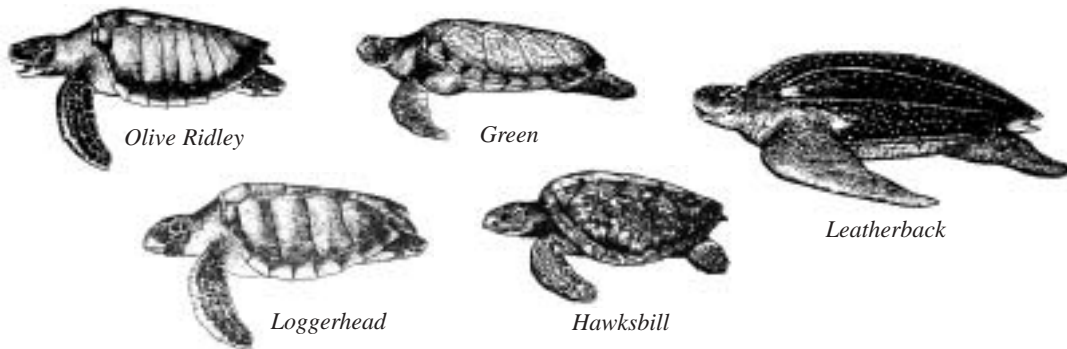

Some fleets, especially the Asian freezer boats, discard some of the byproduct species due to the length of their fishing trips and their limited freezer space. This is called high grading. These fish then become bycatch.

Some Pacific longline fishermen are releasing, alive, small target species as their value is low at a small size, and they have a chance to grow and become more valuable to the fishermen. Technically these released fish are also considered bycatch.



Another form of bycatch are fish, both target and byproduct species, that have been damaged by sharks or toothed whales. In some cases, shark damaged fish may be retained for crew consumption or sale if the damage is limited. However, when toothed whales take fish, they only leave the heads, and these are discarded.

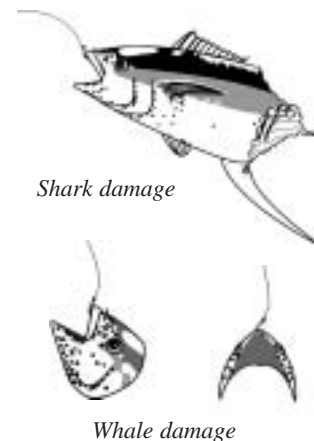

## E. BAIT USED IN LONGLINE FISHING

Bait used for longline fishing is usually frozen whole finfish such as sardines, saury, or mackerel scad. Frozen whole squid is often used for tuna longlining but is more important as bait for swordfish. Live milkfish is also used for tuna longlining, particularly by Taiwanese boats. Table 2 gives the English, French, Japanese, and scientific names of some of the most common longline baits. Many longline operations have adopted the Japanese names for bait species.

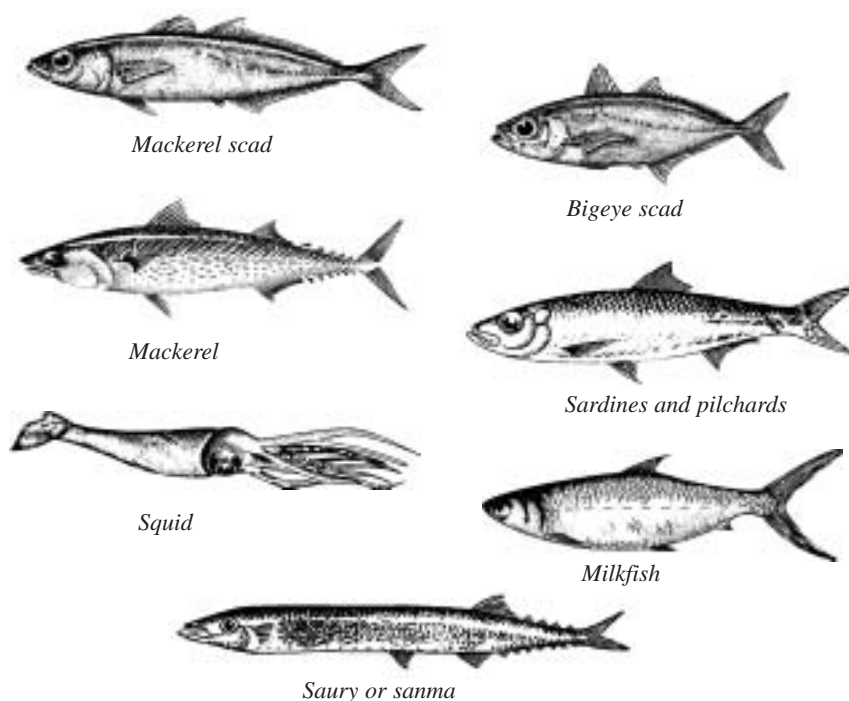

**Table 2: English, French, Japanese and scientific names for the main bait species.**

English	French	Japanese	Scientific
bigeye scad	selar coulisou	me aji	<i>Selar</i> spp.
blue pilchard, Australian pilchard	pilchard d'Australie	iwashi	<i>Sardinops neopilchardus</i>
chub mackerel	maquereau espagnol	saba	<i>Scomber japonicus</i>
mackerel scad	comète	muro aji	<i>Decapterus</i> spp.
milkfish	chanos	sabahii	<i>Chanos chanos</i>
sardine, Japanese pilchard	pilchard du Japon	ma iwashi	<i>Sardinops melanostictus</i>
saury	balaou du Pacifique	sanma	<i>Cololabis sairi</i>
squid	encornet, calmar	ika	<i>Illex</i> spp.

Commercially available frozen bait usually comes in 5, 10 or 25 kg boxes. Longline operators often import bait by the container. The most popular baits come in boxes of 100 to 120 pieces per 10 kg box. The average bait weighs about 80 to 100 g. If the bait is much bigger than 120 g it is likely that some target fish will be missed. Fishermen have reported getting back just the head of the saury, for example, when fishing for albacore and using baits larger than 120 g. With smaller bait the target fish eats the whole piece and is more likely to be hooked. When fishing for broadbill swordfish, on the other hand, squid as large as 200 to 300 g are used.

### Bait rigging

Saury (sanma), one of the most popular baits, especially when albacore is the target species, is usually hooked through the top of the head with the hook going forward. The saury appears to swim naturally when hooked this way. There is a little white dot on the top of the saury head. This is where the hook should penetrate.



Other baits, such as pilchard and sardines, are usually hooked through the back or just behind the head. The best way to hook bait is to hold the fish in one hand and the hook in the other hand. The shank of the hook is pinched between the thumb and second finger while the forefinger rests over the bend of the hook. As the point penetrates the bait, the hook is turned in one rapid motion.

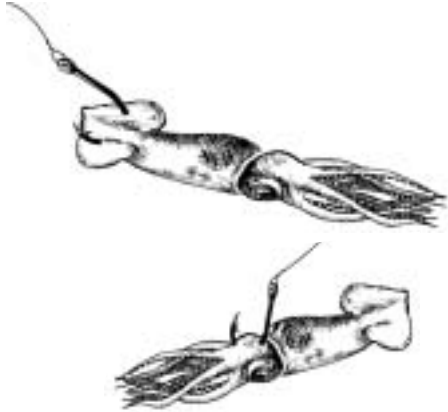

Squid is usually hooked near the tail so that it hangs naturally. With squid it is a good idea to run the hook through twice so that the bait is not lost. Some fishermen prefer to hook squid through the beak with the hook exiting the head between the eyes. This way the hook goes through the cartilage ring that supports the tentacles.

Milkfish can be used as live bait or as fresh or frozen dead bait. When it is used as live bait the milkfish is hooked through the back in a way that will not kill it.

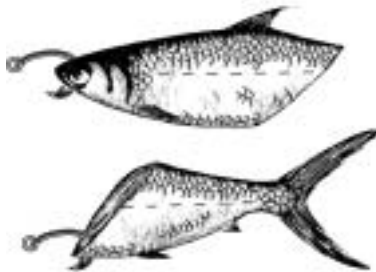

Fishermen have reported that some milkfish survive for more than one set and can be used as live bait twice. Live milkfish are more effective for shallower species such as yellowfin tuna and striped marlin, and are not as effective when fishing for bigeye tuna. Some fishermen use live milkfish on the hooks near the floats and use some other bait such as frozen saury on the deeper set hooks. Larger, dead milkfish over 120 g in weight can be cut diagonally through and used as two baits.

If a longline boat runs low of bait near the end of a trip, the bait supply can be supplemented by cutting up other species. Billfish, including sailfish and shortbill spearfish, make reasonable longline baits. The flesh should be cut in diagonal strips about 20 cm long, 5 cm wide, and 2 to 3 cm thick. A piece of skin should be left on each piece of bait — this is where the hook penetrates. One average sized marlin can yield several hundred pieces of longline bait. Cut bait will keep longer if it is salted.



Some longline fishermen save good bait to reuse a second time. Durable bait, such as sanma or squid, are most suitable for reuse. Good baits that have not started to decompose are removed from hooks during hauling and are stored in a bucket of heavily brined seawater. They are mixed with fresh baits for the following day's fishing. Reused baits are not hooked in the same place the second time around.

## F. HANDLING, PREPARING AND SPLICING ROPES AND LINES

A good fisherman should know a lot about ropes and lines and how to work with them. Most lines on fishing boats are made of synthetic rope — Nylon (polyamide), Kuralon (polyvinyl chloride), Teton (polyester), or Danline (polypropylene). Polyvinyl chloride and polyester ropes are preferred for longline fishing because they are negatively buoyant, almost as strong as nylon, and do not stretch as much as nylon. Nylon rope is also negatively buoyant but, because it stretches, it is not usually suitable as fishing line. It is, however, preferred for anchor lines and mooring lines. Monofilament (single fibre) nylon is suitable for fishing lines, however. Polyvinyl chloride and polyester ropes used for longline fishing are usually tarred with a mixture of coal tar and kerosene (black line) or synthetic vinyl tar (red line), and they are called tarred line. Tar protects the line from chafing and from the sun and salt.

Typical rope is composed of three twisted strands, and is called three-strand rope. The direction of the lay is usually right-hand or 'Z' twist. Rope can be very tightly twisted, or hard lay, or it can be loosely twisted, or soft lay. Generally, most rope on a fishing vessel is in between hard and soft lay and is called medium or standard lay. Medium and soft lay ropes are easier to splice and tie than hard lay ropes.

Braided rope is made from 8 or 12 strands that lay alternately left and right. Braided rope is not usually used on fishing gear. It is often used on winches and on rigging, however, as it does not twist or kink. Some braided rope has a braided core. This type of rope is called Samson braid or double-braided rope.

Any rope is called a rope until it is put to use. Then it is referred to as a line. The main body of a line is called the standing part, a coil formed to make a knot or to round a block is called a bight, and the end of the line used for making a knot is called the bitter end. A knot is a combination of coils used to tie lines together or to tie lines to objects. A bend is a knot used to tie two lines together. A hitch is a knot used to tie a line to some object.

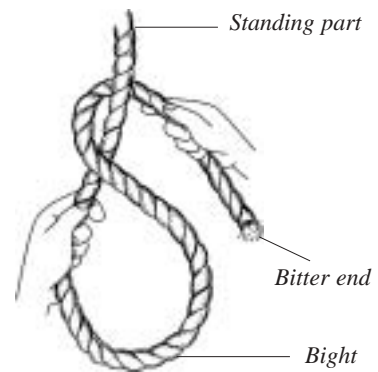

### Measuring out

Some of the gear described in this manual requires ropes and lines to be measured out so that, when finished, the gear will be fishing at a known or predetermined length. The easiest way to measure out the length of a piece of rope or line is for the person doing the job to first measure his arm-span, then count out the correct number of spans that will give the required length of rope. A typical adult male arm-span is around 1.8 m (one fathom).

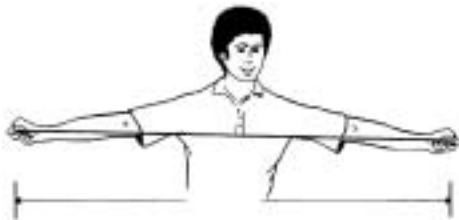

### Splicing

There are three splices that are important to know for longline fishing: the eye splice, the double splice, and the back splice. There is a fourth splice, the short splice; however, this is not recommended for joining tarred line. Splices are easier to make in tarred rope if a Swedish fid is used; however, a steel spike or a marlinspike will do. A Swedish fid is a hollow fid that is left in the lay of the rope until after the strand is tucked back into the lay. A good pair of wire cutters is also needed. Wire cutters are better than a knife for cutting tarred rope.

Three tucks are all that are necessary when splicing three-strand tarred rope. One tuck is finished when all three strands are tucked under the lay. The ends of the strands do not have to be burnt, whipped, or taped, as the tar holds them together during splicing. After the splice is finished, the ends can be trimmed off even; they will not pull through the tuck as the tar holds them in place.

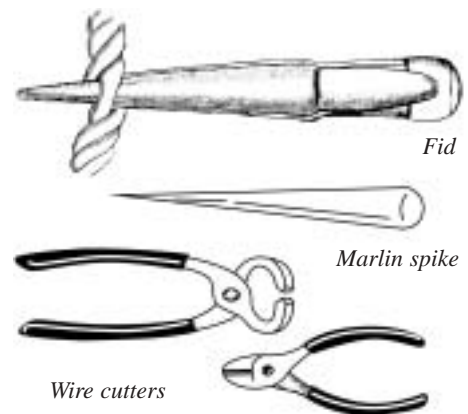

**Eye splice:** also called a side splice, is used to make a loop, or eye, in the end of a floatline, section of basket gear mainline, or for attaching swivel snaps to floatlines. The strands are tucked back into the standing part of the line from the side, forming a closed bight. A very tight eye splice is used to attach swivel snaps.

*Unlay the rope strands and pass the strands through the standing part ...*



*...of the rope so they are at the same level*

*Pass each end over the strand and...*



*...under the next until the splice is complete*

**Back splice:** is one way to make a stopper knot on three-strand line. A stopper knot is a knot on the bitter end of a line that prevents the line from passing through a block or cleat. A back splice is also useful to keep the bitter end of a line from unravelling. A back splice is made by first tying a crown knot. Then two or three tucks are made back into the lay.

*To tie a crown knot, unlay the end of the rope, form a loop...*

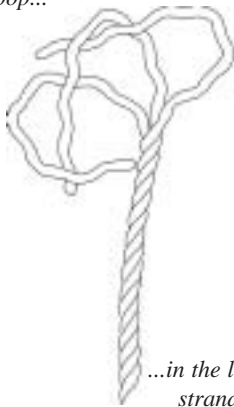

*...in the lower strand and pass the middle strand over the lower strand and down through the loop*

*Repeat the procedure, passing the upper strand over the middle ...*

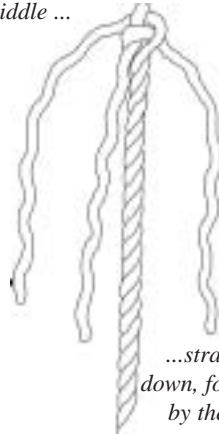

*...strand and down, followed by the lower strand over the upper strand and down through its loop and pull tight*

*Like the eye splice, pass each end over...*

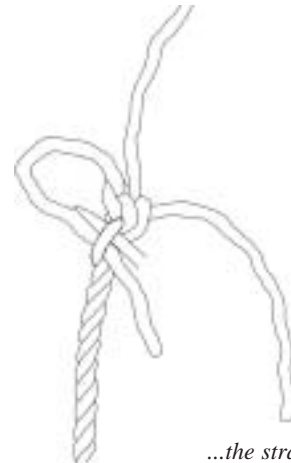

*...the strand and under the next until the splice is complete*



**Double splice:** or fisherman's splice, is similar to making two eye splices, and is the best splice for joining tarred rope. However, instead of splicing the end of a rope back into itself, two ropes are used, with the bitter end of each one being spliced into the standing part of the other.

*Unlay the two rope ends, lay the ropes parallel with the unlayed ends facing the opposite directions and pass the strand ends from one rope through the standing part of the other*



*Pass each end over the strand and under the next until the splice is complete, exactly as for an eye splice*



*Repeat with the other set of rope strands, passing the strand ends through the standing part of the other rope*

## G. GENERAL KNOTS

The following diagrams illustrate some of the knots that are useful to a longline fisherman.

### Overhand knot

The overhand knot is the simplest knot and is useful as a stopper knot, or to quickly keep the ends of three-strand rope from unravelling, or to join two lines as a makeshift repair.



### Fisherman's knot (also called lovers' knot)

A fisherman's knot is a good way to join two pieces of three-strand or braided line of the same diameter in a hurry. It is made by tying two overhand knots in the bitter ends of the two lines that lie over the standing parts of each other.



### Bowline knot

A bowline is a all-round loop knot that has a lot of applications for fishing as well as for general purposes on a fishing boat. A bowline is useful because it is easy to tie, will not slip, and is easy to untie even after a load has been placed on it. However, it is not good for slippery lines and will not hold in nylon monofilament.

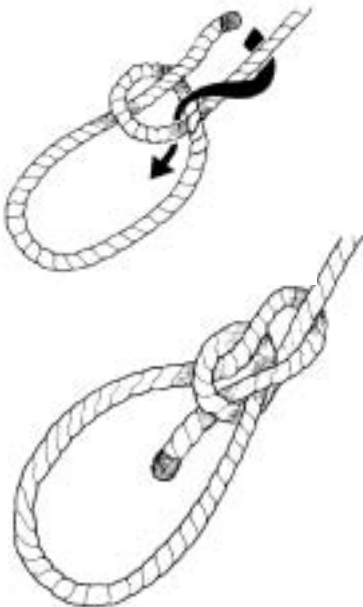

### Sheet bend and double sheet bend

A sheet bend is useful for joining two lines of the same or different diameters. It is quick to tie, will not slip, and is usually easy to untie even after a load has been put on it. A variation is the double sheet bend, where the bitter end of one line is wrapped twice around the bight of the other line.

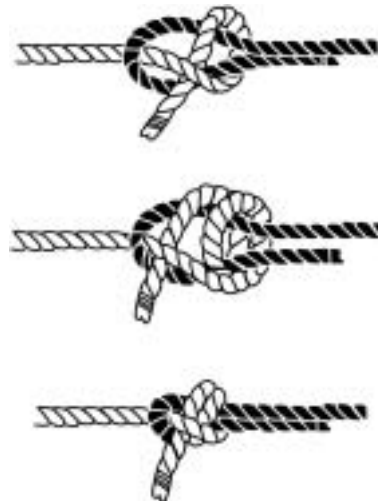

## Slip knot

A slip knot has many uses but the most important use in longline fishing is to tie monofilament or tarred line onto hooks, snaps and swivels. If the supply of crimps is exhausted during a trip, spare branchlines can still be made using slip knots.

*Thread the line through the eye of the hook or swivel, then ...*

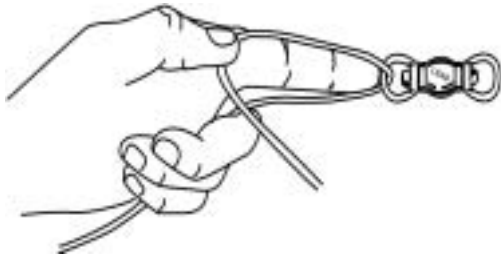

*...run the line around the end of your finger and hold it in place with your thumb*

*Take four or five loose turns with the bitter end around the finger, working back ...*

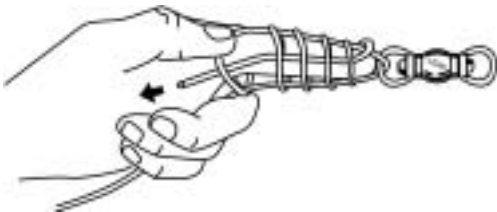

*...towards the fingertip, then pass the bitter end back along the finger inside the loose turns*

*Remove your finger, holding the turns ...*



*...in place with the other hand*

*Pull tight*



## Figure of eight knot

A figure of eight knot is good for a stopper knot on three-strand or braided line and is also useful for making a quick loop in the bitter ends of monofilament mainline for snapping the end (first or last) floatline.

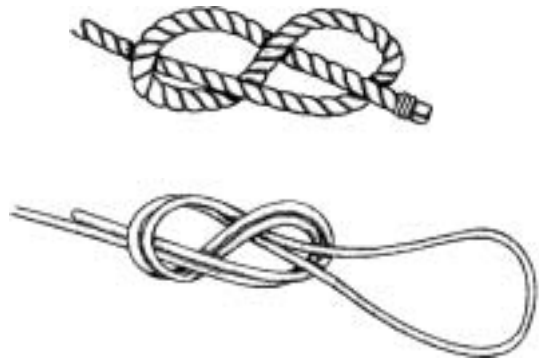

## Half hitch and clove hitch

A half hitch is a simple knot that consists of a single bight with the standing part laying over the bitter end. It is also a basic element of many other knots such as the clove hitch. A clove hitch is two overlaying half hitches. A clove hitch is useful for tying a line to a post or rail. It is also used to secure coils of line, floats, radio buoys, etc. to a rail. A clove hitch should never be used to tie a mooring line to a bollard or a bitt (Chapter 1 I).

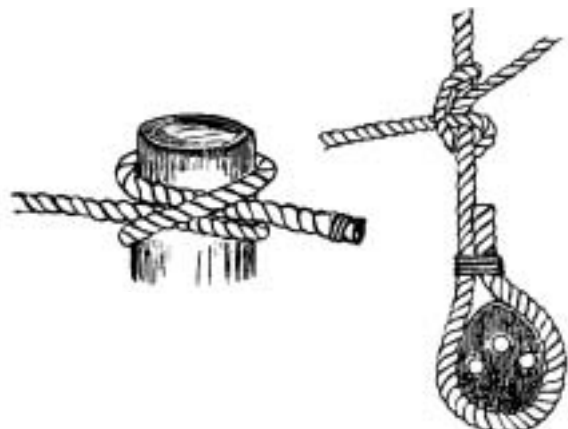



## H. KNOTS USED WITH MONOFILAMENT AND THE USE OF CRIMPS

Monofilament and some other light lines cannot be spliced, so special knots are used. All knots will weaken a line, sometimes reducing its breaking strain by more than half. The blood knot and the double slip knot are recommended as being the strongest methods for joining monofilament, and the least likely to slip.

### Blood knot

A blood knot is used for joining two lines of the same diameter. It is a good knot for joining monofilament mainline as it will not slip and it retains about 85 to 90 per cent of the strength of the line.

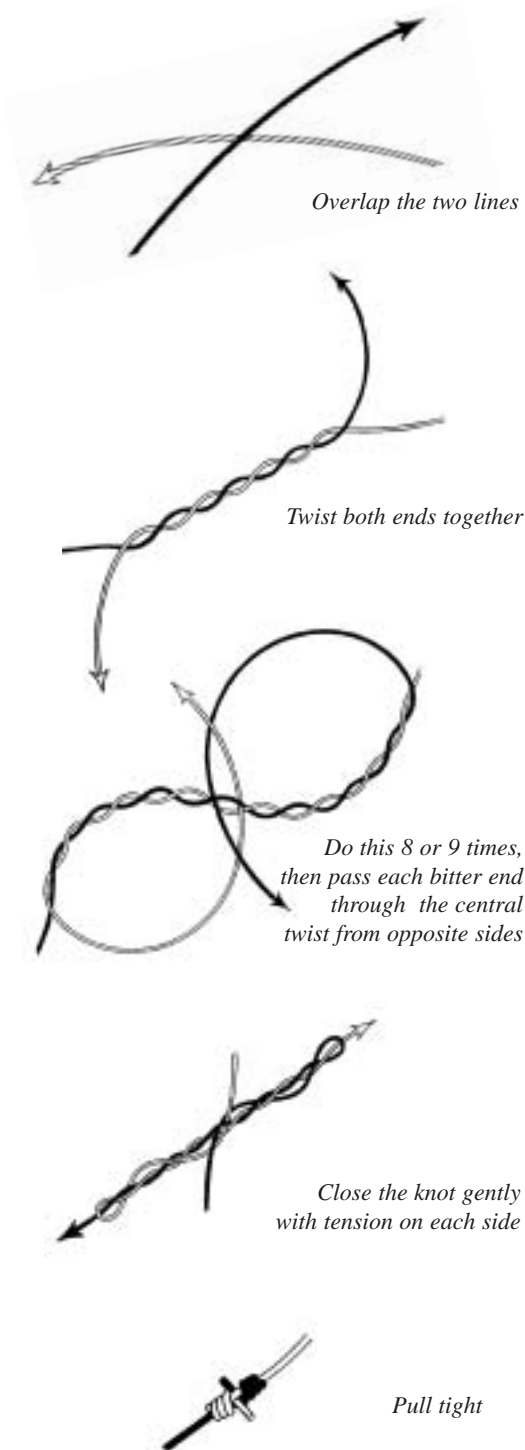

### Double slip knot

A double slip knot is used to joint monofilament or light lines, generally of less than 3.0 mm in diameter. The knot is strong, and the bitter ends lay parallel to the standing line when the knot is complete.

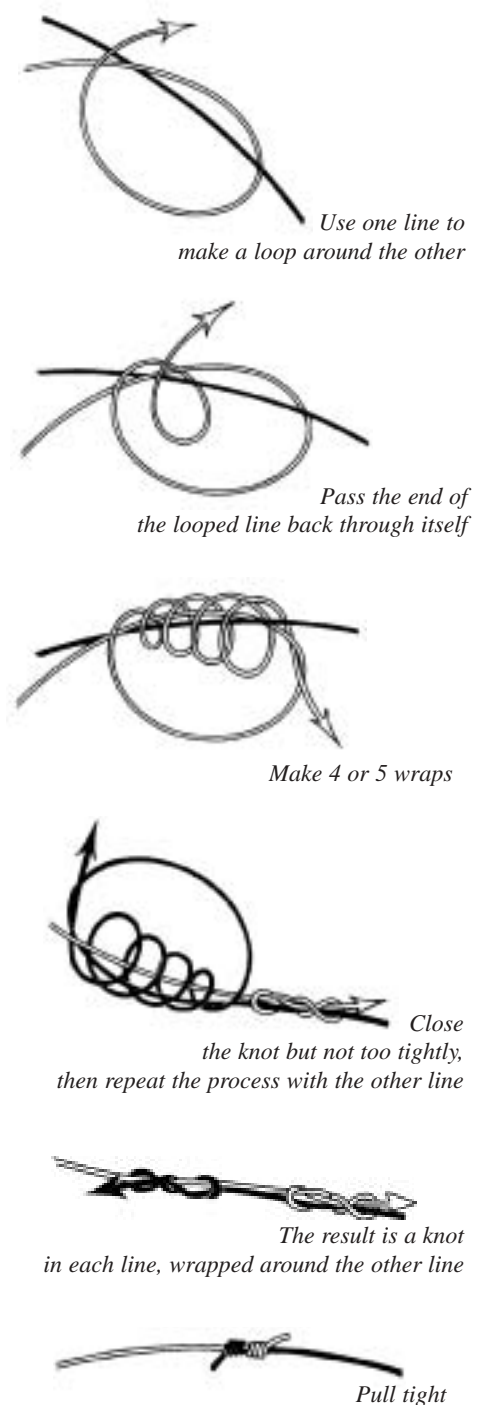

## Sleeves (crimps)

Sleeves, also called crimps or swages, are small pieces of metal tubing that are crimped over the doubled end of a piece of monofilament line or wire trace to form a loop or eye. The eye can be used for forming an eye-to-eye connection, or small eyes can be crimped around hooks, swivels, or snaps. Sleeves are used for making branchlines but are not usually used on the mainline of monofilament gear, as this is impractical and can be dangerous. A bench press or bench crimper is generally used to secure the sleeves, although hand crimping pliers can also be used. Other tools needed include monofilament cutters and wire cutters.

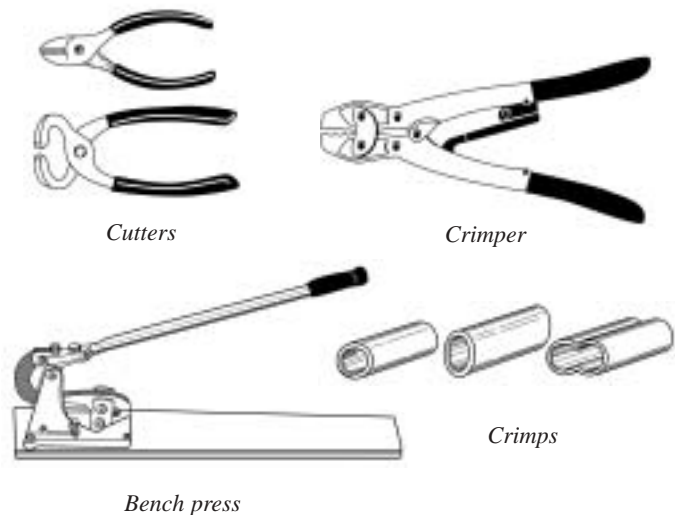

Most monofilament branchlines are made with 1.8 to 2.1 mm diameter monofilament. The sleeve used for this monofilament is called a D-sleeve, and when using a bench press, a D-chip or die is used. The die is a hardened steel jaw that squeezes the sleeve. If wire traces are used then a smaller sleeve and chip are used. The sleeve used for 1.6 mm stainless steel trace wire is a No. 3 sleeve. The chip used with 1.6 mm wire is a 2/3-chip. Generally, aluminium sleeves are used with monofilament and nickel-plated brass sleeves are used with stainless steel or galvanised wire.

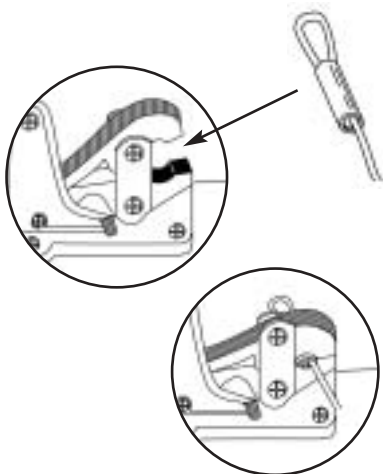

To make an eye using a sleeve, push more line through the sleeve than is needed. The bitter end is then pushed back through the sleeve in the opposite direction. Monofilament line will pass back through a sleeve easier if it has been cut at an angle rather than straight across. The standing part of the line is then pulled until the eye is the right size, while the sleeve is held with the other hand or gently with the wire cutters. Sleeves can be held in place by slightly squeezing them with the wire cutters. The bitter end of the monofilament or wire should not protrude beyond the sleeve but should be flush. If the bitter end is left sticking out this will cause tangles or injuries to the fishermen's hands. The sleeve should be placed in the chip of the bench crimper so that it is in an up-and-down position, not sideways. The sleeve should also be placed so that it protrudes slightly from either end of the chip. It is not necessary to use two sleeves for each eye; one will do.

## Loop protectors

Loop protectors are usually used in the loops of monofilament branchlines to keep them from chafing. They can be green springs, plastic tubing, or plastic thimbles. Some fishermen have quit using loop protectors — instead, they double loop the monofilament in the ring of the hook or the swivel of the snap before crimping it.

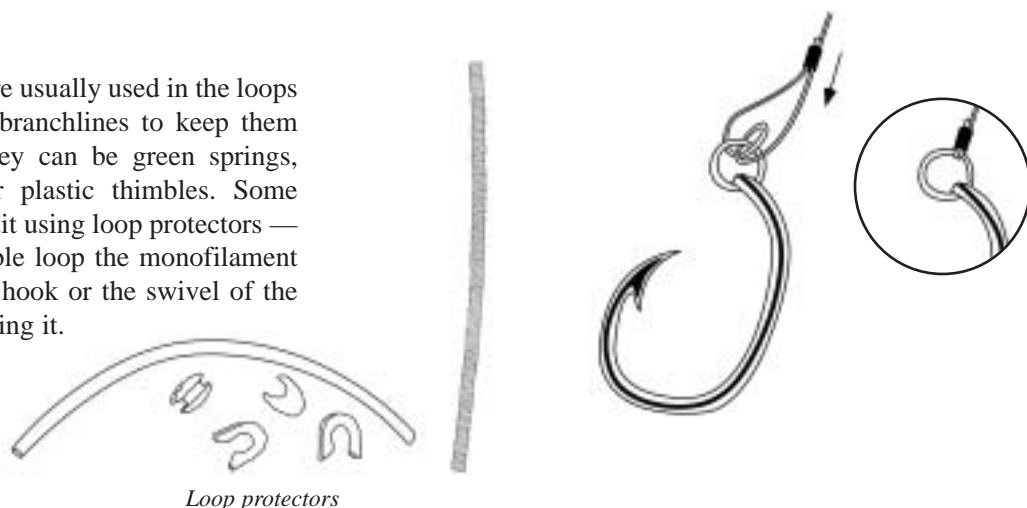

## I. WORKING WITH ROPES AND LINES

Ropes and lines should be used and stored correctly to maximise their working life and to make them readily accessible. Lines should be clean and dry before they are stowed away and they should be stowed out of direct sunlight.

### Uncoiling new rope

When new rope is being removed from a coil it should be pulled out from the centre of the coil so that it is spooling in a left-hand direction — the opposite way that it was coiled at the factory. If rope is uncoiled from the outside it will kink, and possibly become tangled if one bight pulls into the others in the coil. If only a portion of a coil of new rope is going to be removed, then the bitter end remaining on the coil should be tied in an overhand knot so that it will not get lost in the coils.



### Flaking and coiling lines

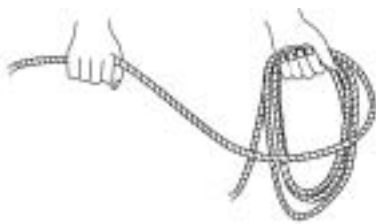

When lines are not being used they should be flaked or coiled and secured somewhere so that they are ready to use. Large diameter lines and very long lines, such as anchor lines, can be piled up or flaked — sometimes called faked — on deck or in a hold or locker. Flaking is a way of laying a line down so that it does not kink or tangle, and so that it is easy to recover in a hurry. Using two hands, the line should be laid over itself in overlapping right-hand coils or in figure of eight coils. The bitter end should be tied in an overhand knot or to a rail so it is easy to spot.

Smaller lines, such as floatlines, should be coiled. Lines should always be coiled in a right-hand or clockwise direction. Right-hand lay line will kink or hockle if it is coiled backwards, or left-handed. A hockle is formed when a strand twists on itself and comes out of the lay. A hockle will weaken a line and the line will eventually part. As line is being coiled, each coil can be twisted to the right between the thumb and forefinger to remove any kinks. Lines on a fishing boat should never be coiled using the hand and elbow method like Boys Scouts do. This will also cause the line to kink and hockle.

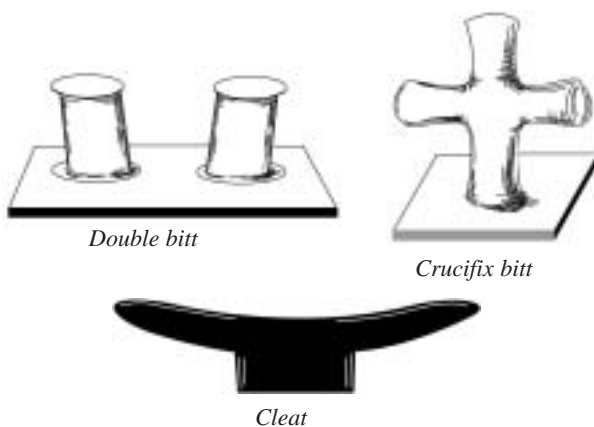

### Mooring lines

Mooring lines are lines used to tie a vessel to a wharf or dock. There are several ways to tie, or belay, a mooring line to a bitt or bollard. On a double bitt or crucifix bitt, the best way is to first take one turn around the bitt, then take several overlapping figure of eight turns with a locking half hitch on the last one or two turns. Mooring lines are belayed in a similar fashion if the boat is equipped with cleats rather than bitts. This arrangement will hold and it is easy to untie later. The best way to secure a mooring line to a bollard on the wharf is to simply drop an eye over the bollard. The line can be adjusted on the vessel.



Dipping the eye is a good practice as a courtesy when there is another vessel's line on a bollard. The eye of the mooring line should be passed up through the eye of the other vessel's line before it is dropped over the bollard. Either line can later be released without disturbing the other. If the line does not have an eye in the bitter end, a bowline is a good knot to use.



If the line needs to be shortened on the bollard, a bollard hitch will do. A bollard hitch is tied by first taking several right-hand turns around the bollard. Then a bight is formed and passed under the standing part of the line and then dropped over the bollard. The hitch can be secured by tying one or two half hitches around the bollard or around the standing part of the line.

### Using a spring line

A spring line is a special mooring line that usually runs from a forward bitt to a bollard on the wharf. It is usually the first line to be thrown when tying up to a wharf and the last line to be released when leaving a wharf. A spring line is used to spring, or pull, a boat into a wharf or away from a wharf, usually when the wind is trying to do the opposite. To dock a boat, the spring line should be thrown over the bollard first as the boat slowly approaches the wharf. At the skipper's instruction, it should be made fast on the forward bitt. The rudder will then be turned away from the wharf and the engine will be going slow ahead. As the spring line tightens, the boat will be pulled into the wharf. Someone should standby a spring line at all times during this manoeuvre in case it needs to be let out or shortened.

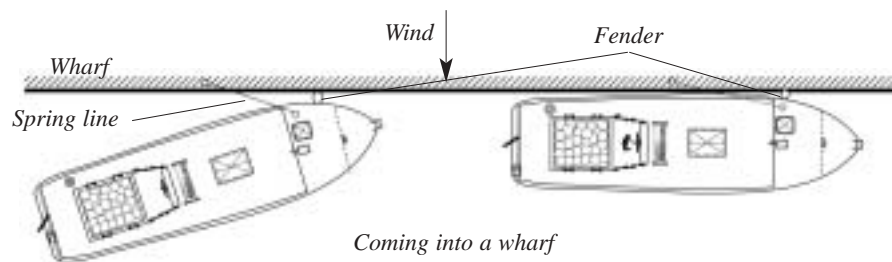

To pull away from a wharf against the wind using a spring line, the rudder is turned toward the wharf and the engine is at slow ahead. As the spring line tightens, the stern of the boat will swing out away from the wharf. A fender should be used on the bow between the boat and the dock during this manoeuvre. Now the boat can be reversed with the rudder turned away from the wharf and the spring line released. If there is nobody on the dock to remove the line from the bollard, a double line should be used. This is called a slip line. The bight of the slip line should pass over the bollard. One end of the slip line can be released from the bitt and the other end pulled to recover the line.

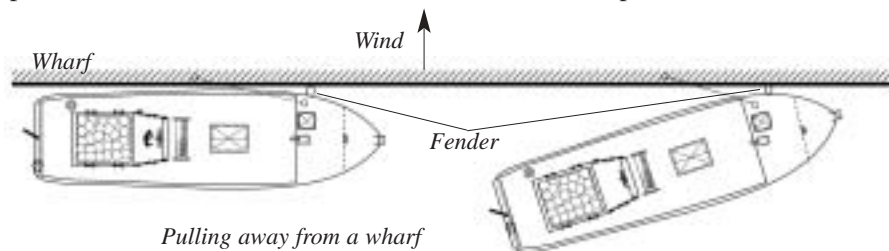

### Using a capstan

Capstans are hydraulic or electric spindles that rotate slowly but with lots of power. They are used for heaving anchor hawsers or mooring lines. Sometimes they are used for lifting fish out of a fish hold on a boom. Pulling a line with a capstan can be dangerous if not done properly. Three or four turns around the capstan are usually enough. The turns should be made from the inside toward the outside of the capstan. As the capstan turns, the outside turn is pulled off and flaked down on the deck. The capstan should be doing all of the work. The person pulling the line should only be keeping the line taut and removing line from the capstan. Another person should be operating the control valve for the capstan. He should not leave this post while the line is being pulled. If the line jams, he should stop the capstan immediately. Nobody should be standing in the bight of the line.



## J. LONGLINE BOATS

Longline vessels can be divided into three broad categories: small-scale (under 15 m and less than 20 GRT), medium-scale (15 to 25 m and less than 100 GRT), and large-scale (over 25 m and over 100 GRT). Some vessels have the cabin forward and the working area aft, while others have the opposite layout. Both work successfully, and it is up to the individual to choose the size, design and layout he prefers.



*Longline vessel with a forward wheelhouse*

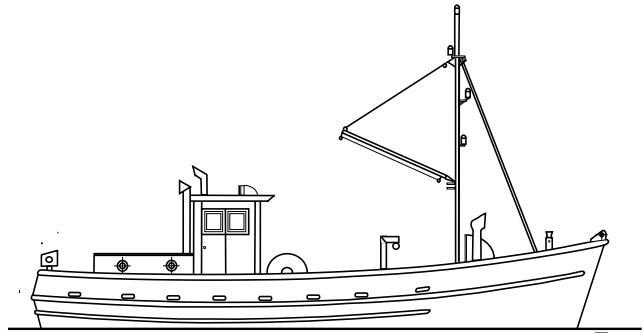

*Longline vessel with an aft wheelhouse*

### Small-scale longliners

Small-scale longline boats include artisanal vessels and *alia* type catamarans that use either hydraulic or hand operated longline reels capable of setting and hauling 300 to 400 hooks per day. Most small-scale longliners use monofilament longline systems (Chapter 2 A). These boats have limited operating range and limited fish holding capacity, but have been quite effective in some localities — for example, Samoa. What they lack in production capabilities is often made up for because they are inexpensive to purchase and operate. The original *alia* catamarans were 8.5 to 9.5 m long and usually went out on day or overnight trips, and made just one or two sets in coastal waters ranging from 10 to 50 nm offshore. The crew on an *alia* catamaran might be two to four fishermen. *Alia* catamarans are only capable of holding about 1 mt of fresh fish, and some do not have icing capabilities but bring the fish back to port to be iced or frozen.

Several designs of larger aluminium catamarans have been developed in Samoa and New Zealand, in the 12 to 13 m range. They can carry around 3 mt of chilled catch, set 500 to 1000 hooks per set, can stay at sea for three to five days, and carry a crew of four or five.

Monohull vessels in the 13 to 15 m range have also been used for tuna longlining. These vessels usually set 400 to 1000 hooks per set, stay at sea for three to six days, carry around 2 to 4 mt of chilled fish, and have a crew complement of three to five.

The size and limited capacity of small-scale vessels greatly restricts their movement, and they cannot follow fish like the medium-scale vessels.



*Original alia catamaran rigged for longlining*



*Super alia design catamaran*

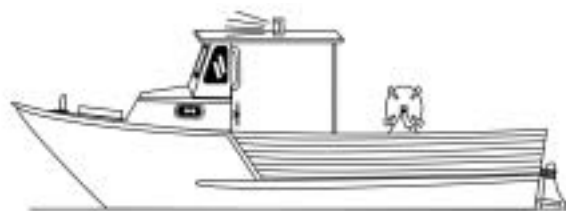

*Small-scale monohull longliner*

## Medium-scale longliners

Medium-scale longliners have greater operating ranges and fish holding capacities than small-scale longliners, and thus are able to fish within a country's entire EEZ and even outside the EEZ on the high seas. Medium-scale longliners can stay out for one to three weeks and have operating ranges of up to 6000 nm. They are capable of setting and hauling between 1200 and 2500 hooks per day and can make about 10 or 12 sets per trip. For these reasons, they are the most popular size of vessel in Pacific Island longline fleets.

Both traditional basket gear (Chapter 2 A) and modern monofilament gear can be found on medium-scale longliners. The average medium-scale longliner is capable of holding from 10 to 20 mt of fresh chilled fish. The crew complement on a medium-scale longliner might range from four to eight fishermen. Medium-scale longliners in the Pacific are often boats that have been in another fishery before being converted to longline fishing. Trawlers, bottom fish boats, trollers, and even squid jiggers have all been successfully converted to longline boats. Many PICT fisheries have chosen second-hand Asian longliners. Longliners can have single or multiple fish holds, fish preservation can be by ice or CSW or RSW (Chapter 4 G), and the hull material can be steel, fibreglass, aluminium, or wood. New medium-scale vessels purpose built for longline fishing come from shipyards in Australia, Fiji Islands, France, New Zealand, Taiwan, People's Republic of China, United States, and Tahiti.

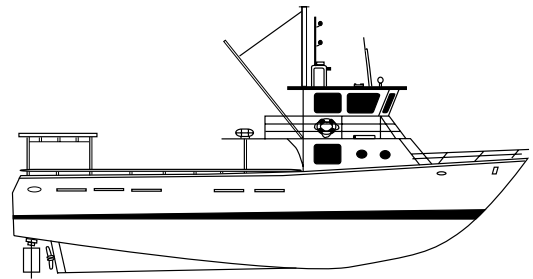

*Medium-scale longliners*

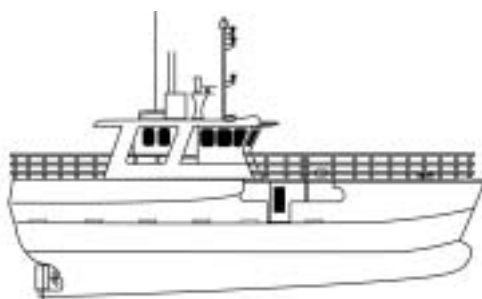
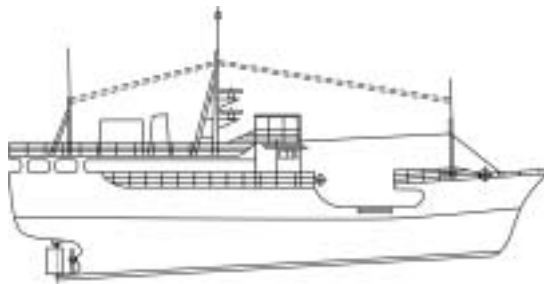

*Large-scale longliners*

## Large-scale longliners

Large-scale longliners include freezer albacore boats and freezer sashimi boats. Their operating range includes all of the world's oceans. They can stay at sea for several months at a time, conducting from 50 to 100 sets or more per trip and setting from 2500 to 3500 hooks each day. Most freezer longliners use automated basket gear (Chapters 2 B and 3 L) systems. Freezer longliners have crew complements ranging from 20 to 28 fishermen. They are capable of holding up to 100 mt or more of frozen fish.

There are also a few large-scale longliners that target fish for export to overseas markets as fresh chilled fish. These vessels generally have a freezer to freeze and store albacore, which is sold to tuna canneries in the region. For large-scale fresh fish longliners, the fishing gear and technique is similar to medium-scale operations, with a crew of 10 to 12, 1500 to 2500 hooks being deployed per set, and fishing for up to 12 sets before returning to port to unload the catch.

An exception to the above is the large-scale vessels in French Polynesia that target albacore, freezing the processed loins (Chapter 4 E). These vessels chill other tunas towards the end of their 40 to 50 day trips to land fresh for export.

## K. SEA SAFETY APPLIANCES AND EQUIPMENT

The array of safety appliances and equipment required on a fishing boat depends on a number of factors: the size of the boat, its operating range, the crew complement, and the regulations in force in the country where the boat is operating. The following list of safety gear is the minimum required on a medium-scale longliner that operates within Pacific Island EEZs — out to 200 nm.

**Life raft:** suitable for the number of persons on board — this should be an offshore model, SOLAS (Safety of Life at Sea Convention) compliant or equivalent. It should contain an EPIRB (see below), a SART (search and rescue transponder), distress signals, food, water, a torch or flashlight, a bailer, a knife, a patch kit, an air pump, a sea anchor, a heaving line, a water distillation kit, a medical kit, and a fishing kit. The life raft should be self-launching, with a hydrostatic release mechanism.

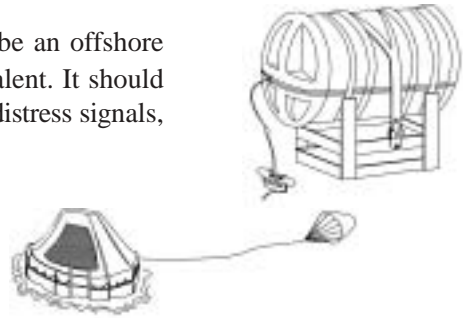

**Offshore life jackets:** or Type 1 PFDs (personal flotation device) — one for each person on board. These should have lights, whistles, and reflective tape.



Life jacket

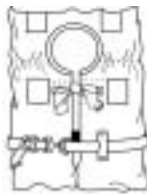

PFD jacket

**Life ring:** with lanyard and light. This should be marked with the boat's name and should be mounted properly, not stored away.

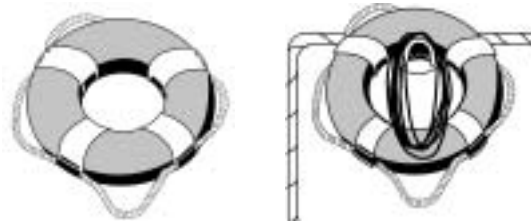

**Distress signals:** 2 rocket flares, 2 smoke signals, 6 hand flares, in a watertight container.

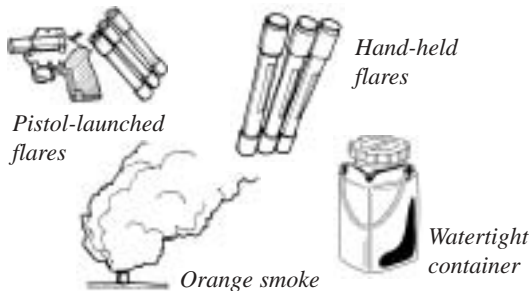

**EPIRB (emergency position indicating radio beacon):** 406 MHz model is preferable to a 121.5/243 MHz model. The EPIRB should have a hydrostatic release mechanism.

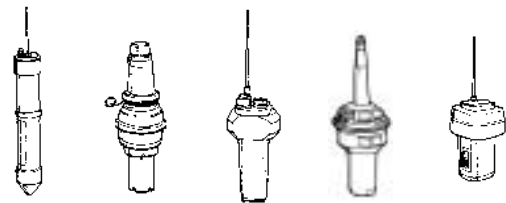

**Fire extinguishers:** CO<sub>2</sub> and dry chemical are best on fishing boats, as they are suitable for all types of fires including electrical fires. It is better to have more than the minimum number of extinguishers required, especially on a fibreglass or wood boat.



**Pumps:** bilge pumps and wash down pumps can be used to fight fires but it is good to have a hand operated pump as a backup.

**Medical kit and medical book:** at least one person on board should have some first aid training including CPR (cardio-pulmonary resuscitation), and the boat should have a well equipped first aid kit including sutures.



**Up-to-date charts:** are required for all areas of operation and ports to be entered.

**Navigation and miscellaneous tools:** wheelhouse compass, clock, barometer, dividers, parallel rule, etc.



*Parallel rule*



*Barometer and clock*



*Compass*



*Dividers*

**Wheelhouse books:** Light List, Pacific Sailing Directions, International Regulations for Preventing Collisions at Sea, IALA System of Buoyage, Chart Symbols and Abbreviations, Ship's Medical Book.



**VHF radio and SSB radio** (Chapter 2 H): These should have a power source that is independent of the main power source from the engine room; i.e., an isolated back-up battery bank (battery bank in the wheelhouse, for example). The 2182 MHz channel on the SSB and Channel 16 on the VHF should be monitored 24 hours a day while at sea.

**GPS or global positioning system and GMDSS or Global Maritime Distress and Safety System:** Chapter 2 H covers these systems.

**Other items:** fire hoses and nozzles, metal fire buckets, torches (flashlights) and binoculars.



*Binoculars*



*Torch*



*Metal fire bucket*



*Fire hose nozzle*



*Fire hose*

**Engine room alarms:** including main engine and generator oil pressure and coolant temperature alarms, bilge high water level alarm, and high heat and fire detection alarm. The galley should also have a fire detection alarm.

**General alarm:** to alert everyone on board in case of an emergency.

**Anchor and anchor chain:** or cable and rope suitable for the vessel's size, and a sea anchor.

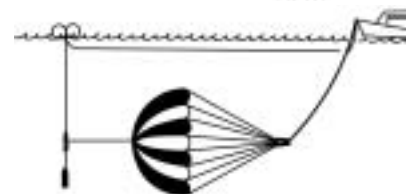

The above list of safety gear represents the minimum requirement. It is a good idea to have back-ups and even more equipment and supplies than is required by regulations. Two good examples of this are fire extinguishers, and the food and water supplies provided on life rafts by the manufacturers. The minimum number of fire extinguishers usually required on a fishing vessel would not be adequate on, say, a fiberglass boat with an engine room fire. To be safe it would be better to have more than the required number of extinguishers. The food and water supplied with a life raft are usually only enough for about seven days. Extra emergency food and water should be stored in a place where it is readily accessible. Spare fishing gear should also be packed with the emergency food and fresh water.

Many of the items in the list above have limited shelf lives and have to be renewed or inspected regularly. A life raft that is ten years out of service would probably not inflate upon deployment. The food ration in such a life raft would undoubtedly be spoiled. Fire extinguishers that are empty will not put out fires. An EPIRB with dead batteries will not send a signal. It is essential to service and renew all safety appliances and equipment by the expiration dates. All members of the crew should know the location of all safety appliances and they should know how to use them. Regularly scheduled safety drills should be conducted by the skipper. A pre-departure checklist (sample at Appendix E) is a good way to itemise all of the basic safety equipment and other important things that should be checked before departing on a trip.



## L. SEA SAFETY AND THE RULES OF THE ROAD

Commercial fishing is one of the most dangerous occupations in the world. Every year, hundreds of fishermen lose their lives at sea or are injured while working. Sometimes this is due to events beyond anyone's control, such as cyclones or other weather conditions. Most loss of life and accidents at sea, however, are due to human error. Fishing boats and lives are lost because vessels run aground, sink, and catch on fire. Accidents often occur because of poor watchkeeping or carelessness, but accidents can also happen because fishermen venture out in vessels that are not seaworthy. Lives are sometimes lost because when disaster strikes the boat and crew are not prepared.

The risks can be minimised if some basic common sense principles are followed. Weather conditions should be checked prior to departure and the weather should be monitored on a daily basis throughout the fishing trip. Weather warnings should be heeded. Diligent watchkeeping is the only way to ensure that a boat steers a true course and does not collide with other vessels or run aground. A boat should not go to sea unless it is fit and seaworthy. This means that the boat is in survey and that all pumps and alarms are working, including high bilge water alarms and engine room fire alarms, and all safety appliances and equipment including life raft, EPIRB, and fire extinguishers are in good order. Filling out a pre-departure checklist (Appendix E) should be a regular routine before every fishing trip, and safety drills should be held before each trip so that all members of the crew know where to find and how to use all safety equipment. All members of the crew should have basic training in sea safety, fire fighting, and first aid.

Most longline boats are set up so that hauling takes place on the starboard side. The reason for this has to do with the rules of the road. *Rules of the Road* is the common name of the *International Regulations for Preventing Collisions at Sea* — also called COLREGS. Rule 15 states:

*'When two power-driven vessels are crossing so as to involve risk of collision, the vessel which has the other on her own starboard side shall keep out of the way and shall, if the circumstances of the case admit, avoid crossing ahead of the other vessel.'*

From dead ahead to two points aft of the starboard beam is the area ahead of a vessel that is underway that is called the *Danger Zone*. A longline boat that hauls gear from the port side would not necessarily have a good view of the Danger Zone and may be at risk of crossing another vessel's port bow during hauling and, thus, be at risk of collision.

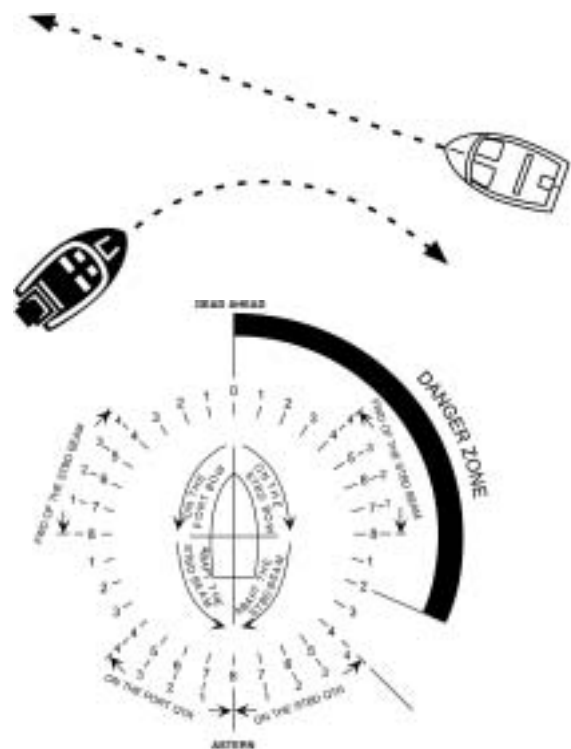

### Watchkeeping

Someone should be on watch at all times while the boat is underway. Some boats do not have autopilots so a helmsman is always on duty to steer when the vessel is moving. This person may be the watchman as well, but in some cases cannot be. A helmsman may or may not be capable of being a lookout, especially when navigating in a harbour or lagoon. It depends on the individual situation.

Rule 5 of the *Rules of the Road* says that, *'... every vessel shall at all times maintain a proper lookout by sight and hearing ... so as to make a full appraisal of the situation and the risk of collision.'*

In foul weather, when visibility is restricted, when there is a nearby reef or shoal, or when there is nearby vessel traffic, someone should be on watch even if the boat is anchored or drifting. Radar alarms, echo sounder alarms, and GPS alarms should not be depended upon. The watchman should not be reading or listening to loud music while he is responsible for the vessel, nor should he be drinking alcohol or smoking marijuana or using other drugs. All watchmen should know the rules of the road. They should also know the fundamentals of navigation and be able to use a compass, read a chart, and use radar, radio and GPS.

According to *Rules of the Road*, a vessel that is drifting is underway. Rule 3(i) states that, 'The word 'underway' means that a vessel is not at anchor, or made fast to the shore, or aground.'

Watchkeeping should include monitoring the boat's position, course and speed, as well as all engine room gauges and bilge water levels. The boat's position and course should be noted on the chart periodically to ensure that it is on course and that no reefs or islands lie in its path. The watchman should be on constant vigil for other vessels by watching the horizon and looking for lights, at night, and by monitoring the radar. The watchman should look in all directions around the boat every 10 to 15 minutes. An overtaking ship may not be able to see a small fishing boat. If land or reefs are near, then the distance to land or the reef and the depth of the water should be watched closely. Both the SSB and VHF radio should be monitored at all times while at sea. The engine room should be checked at least every hour unless there is an engineer on engine room watch.

The watchman should also take a look around the deck at least once during his watch, as long as it is safe to do so. He should check that all navigation lights are operational, that there is no loose cargo or unsecured gear, and that all hatches are secured or dogged tight.

Every longline boat that operates beyond territorial waters — past the 12 nm limit — should have a watch alarm. A watch alarm is an electronic wheelhouse device that is set up to beep at regular 10 or 20 or 30 minute intervals. Each time the beeper goes off, it must be re-set by the watchman. If it is not re-set after one minute, a very loud general alarm will sound. The main function of the watch alarm is to ensure that the watchman stays awake and alert. Watch alarms are usually set and locked by the skipper, and cannot be turned off without a key.

A watch list should be made, showing who is on watch during each block of time. Watches should be rotated on a three hours on, nine hours off basis, or a two on, four off basis, for example. If the watchman is tired and cannot stay awake, he should wake another crew to relieve him.

### Changing the watch

Changing of the watch is very important. The following procedure should be learned by all members of the crew on fishing boats. Ten minutes or so before your watch is over, wake the next watchman. Return to the wheelhouse and wait for him. This gives him time to adjust — use the toilet and have a cup of tea or coffee. If he does not arrive within five or ten minutes, attempt to wake him again. When he does arrive, talk to him to make sure he is alert. Tell him what course you are on and show him your position on the chart. (It is important that you are in agreement on the vessel's position. The new watchman should check the previous watchman's chart work for accuracy.) Make sure he is aware of any possible dangers such as approaching vessels. Tell him when the engine room was last checked and the bilge last pumped and let him know if there are any problems. Stay in the wheelhouse with him for at least five minutes to make sure he is awake and alert. This is particularly important if a long hard day of fishing has just been completed and everyone is exhausted.

If there is any question about the boat's safety during your watch, wake the skipper immediately. He would much rather be disturbed than be told later — when the boat is broken down — that there was a 'funny noise' coming from the engine room during your watch. If you hear anything on the radio that sounds like a distress call, write down the name of the distressed vessel and the position and, again, wake the skipper immediately. If there is a fire or the engine room is flooding or there is some other immediate danger, wake the skipper and sound the general alarm.

Some other things should be checked daily by the skipper or engineer while the boat is underway. These include: the shaft gland or stuffing box, for leaks, the lazarette or rudder room, for leaks on the rudder post and for leaks in the hydraulic lines, and any holds or other compartments for leaks. Engine sump oil levels and service tank fuel oil levels should also be checked daily. Oil pressure alarms and bilge high water alarms are good warning devices but they should not be depended upon.

A skipper can minimise the risk of running aground if he follows the following advice. Check your position regularly, even when it is not your watch. Keep an alarm clock in your bunk and wake up before you arrive at the reef. This is fairly easy to do. Before changing watches, find the nearest reef or land on the chart where your boat could run aground if you went off course during someone else's watch. Next, calculate the time necessary to arrive at the reef based on boat speed, wind, and current. Then, set your alarm clock to go off ten or fifteen minutes before you would hit the reef. Last, get up when the alarm goes off and check your course and position. Before going back to sleep, re-set the alarm clock for the next hypothetical grounding.

## Weather

Weather conditions should be checked prior to departure and daily throughout a fishing trip. Weather reports and warnings are given on Inmarsat-C, SSB radio, or weather fax. Weather fax reports show weather analysis and prognosis or forecast charts for different areas in synoptic times (0000 hours, 0600 hours, 1200 hours and 1800 hours UTC). An analysis chart shows the weather patterns as they are at that point in time, while a prognosis chart shows what is expected to happen in a specified time period. An analysis chart shows weather fronts, troughs, ridges, and wind speed and direction. A front is a place where two different air masses are coming together. A front can develop into a trough or a ridge. A trough is an extended depression where the atmospheric pressure is relatively low along a line. A ridge is just the opposite — a line of high pressure. Troughs usually indicate foul weather while ridges indicate fair weather.

Both analysis and prognosis charts show high and low pressure areas on a large scale — several hundred nautical miles. Pressure systems are depicted by isobars. An isobar is a line connecting places with the same barometric (atmospheric) pressure. Average atmospheric pressure is about 1013 millibars. If the pressure drops below 1000 millibars, foul weather should be expected.

A tropical depression (TD), which can develop into a cyclone, is seen on an analysis chart as concentric isobars (a series of encircling rings) with the lowest pressure in the centre. Lows, or tropical depressions, are labelled as L or TD on a weather chart while tropical cyclones are labelled TC and usually have a name. Highs are the opposite of lows and are seen as concentric isobars with the highest pressure in the centre. Highs are labelled H.

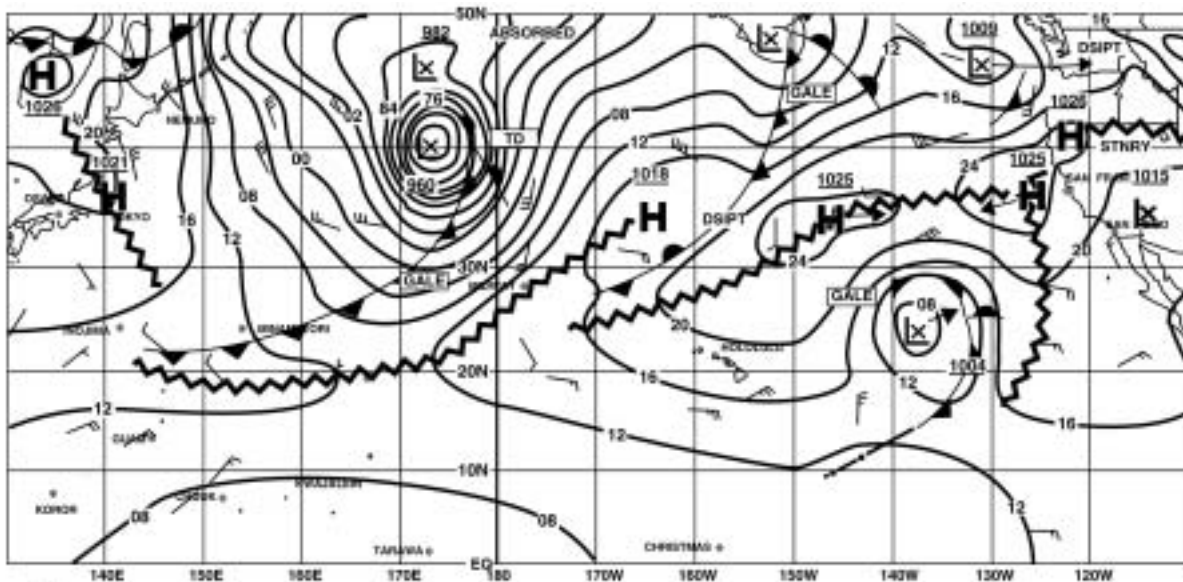

<b>H</b> 1024	CENTER OF HIGH PRESSURE WITH PRESSURE IN MILLIBARS		TROPICAL DEPRESSION(TD)		5 KT
<b>L</b> 999	CENTER OF LOW PRESSURE OR TD WITH PRESSURE IN MILLIBARS		CYCLONE (TC)		10 KT
	COLD FRONT		CONVECTION		15 KT
	WARM FRONT		SQUALL LINE		20 KT
	STATIONARY FRONT		TROUGH LINE		25 KT
	OCCLUDED FRONT		TRIDGE AXIS		35 KT
	DRY LINE		GALE OR TRIPCL STORM		50 KT STORM
					74 KT CYCLONE
					105 KT
					24 HR HIGH PRESSURE MOVEMENT
					24 HR LOW PRESSURE MOVEMENT

The barometer should be checked daily and the barometric pressure should be noted in the logbook. Preparations should be made for foul weather if the barometer drops steadily or if a cyclone warning is issued. The deck and all hatches should be secured and a plan should be made to run from the cyclone or to seek a safe anchorage.

## CHAPTER 2

# FISHING GEAR AND EQUIPMENT

- A. *The longline: basic gear configuration and storage*
- B. *Hydraulically powered machinery used with longline gear*
- C. *Mainline and branchline materials and connection points*
- D. *Branchline hardware*
- E. *Making up branchlines*
- F. *Floats, flagpoles and floatlines*
- G. *Radio buoys*
- H. *Vessel electronics*
- I. *Vessel hydraulics*

### INTRODUCTION

This chapter describes the gear and equipment used for horizontal tuna longline fishing activities. It covers the basic gear configuration for both monofilament and rope gear, and the machinery, including hydraulics, used with both types of gear. The different gear components are described covering a selection of items that can be used based on a fisherman's preference, the gear type being used, and the habits of the species being targeted. Rigging the gear is covered to show different configurations that can be used. Vessel electronics are covered in detail as this equipment has become very important in locating good fishing areas and targeting the desired species to maximise catch.

## A. THE LONGLINE: BASIC GEAR CONFIGURATION AND STORAGE

There are two basic types of longlines: traditional rope, also known as basket gear, and monofilament gear — with some combinations and variations. Basket gear evolved during the late nineteenth century and is still in use today, particularly in the Asian fleet. Monofilament gear evolved in the 1980s and revolutionised longline fishing by offering a less labour intensive and more efficient method of catching fish. Fundamentally, however, the two systems are similar.

A longline is made up of units or sections of line that are called baskets. A basket of longline gear is the amount of mainline and branchlines in between two floats. The term is used both for basket gear and for monofilament gear. A basket may contain from 4 to 40 branchlines. Typically, basket gear has small baskets of between 5 and 15 branchlines, while monofilament gear has baskets of between 15 and 40 branchlines. A branchline is a single line, sometimes made up of several materials joined together, with a snap at one end and a hook at the other.

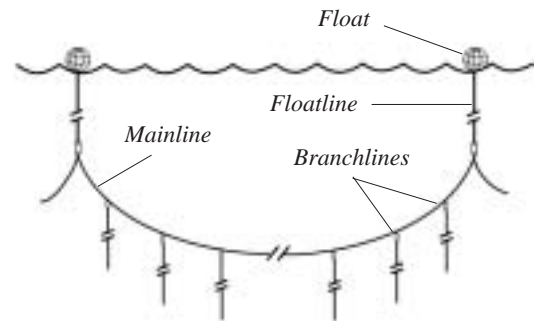

The entire longline might contain anywhere from 20 to 200 baskets, and consist of a mainline 5 to 100 nautical miles long. The mainline is suspended in the water by a series of floats, or buoys, that are attached to the mainline by floatlines. The line is set and hauled once a day from a moving vessel. It is allowed to drift or soak on its own for four to eight hours in between setting and hauling. A typical longline set from a medium-scale longliner would be about 30 to 60 nm long and have about 1200 to 2500 hooks. A typical longline trip on a medium-scale longliner would last about one to three weeks and the line would be set about 6 to 12 times — once each fishing day.

### Basket gear

Basket gear is usually hauled with a line hauler, with the mainline either coiled into some type of basket or tub or tied up into a bundle, and then stowed in a cage or in bins. Branchlines are left connected to the mainline and either placed on top of each successive coil of mainline, or coiled and stored in a separate basket. The branchlines can also be detached and coiled individually, and placed in stacks or baskets for storage. Basket gear generally uses short floatlines and long branchlines to achieve a deep set.

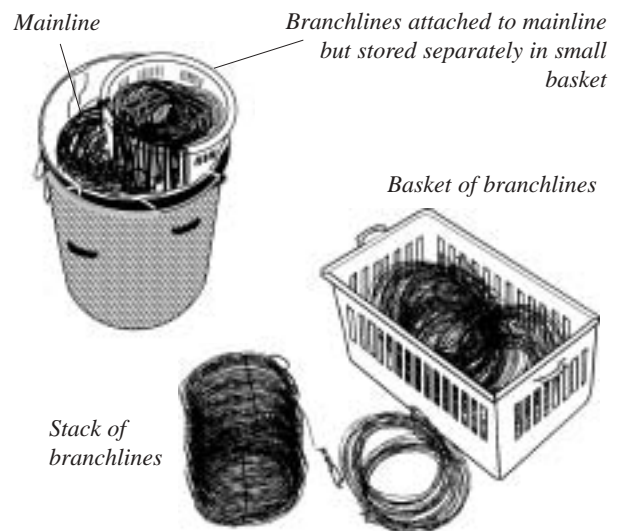

### Monofilament longline

The components of a typical monofilament set are:

- radio buoy and float attached to bitter end of mainline;
- empty basket — 100 to 200 m of mainline with no branchlines;
- double float on 30 m floatline attached to mainline with snap;
- one full basket — 1050 m of mainline with 20 branchlines, each 12 m long, attached with snaps at 50 m intervals;
- single float on 30 m floatline;
- one full basket;
- double float on 30 m floatline;
- one full basket;
- single float on 30 m floatline;
- one full basket;
- double float with flag and strobe light on bamboo pole on 30 m floatline;
- one full basket ...



This pattern is repeated for 50 to 100 baskets. Another radio buoy is attached to the other end of the line following a last empty basket, and there may be two or three additional radio buoys spaced throughout the line. The empty baskets are placed on either end to avoid tangles. A shark or other large fish such as a marlin can swim the bitter end of the line for miles or, worse, tie it in knots. Also, an empty basket gives the crew a little bit of adjustment time when starting and finishing the haul.

Monofilament gear generally uses long floatlines and short branchlines to achieve the same depth of set as basket gear. This can be done because monofilament mainline is easier to haul from deep water as it gives less resistance in the water than tarred mainline. The result is that monofilament gear can get more hooks in the water over a given length of mainline. Another advantage that monofilament gear has over basket gear is that monofilament gear is less labour intensive. Monofilament gear is also easier for the crew to learn. The techniques can be mastered in a few trips, while basket gear may take several seasons to master. Lastly, monofilament gear is easier to maintain. Branchlines and mainline can be repaired easily during hauling operations.

Monofilament mainline is stored on the reel, while the branchlines are detached and stored separately in bins.

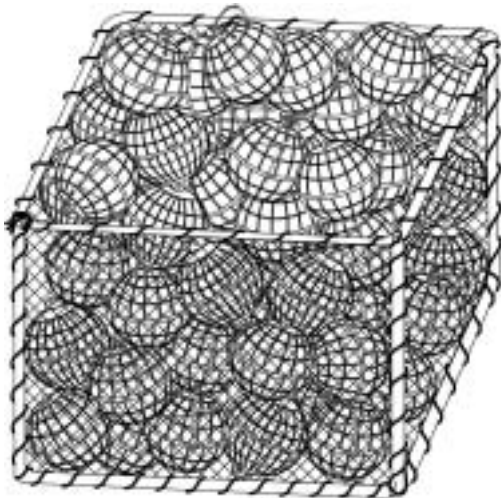

Floatlines are coiled and secured with the bitter end of the line in a quick release half hitch (also called a longline knot). The coiled floatlines are stored in a tub or bin.

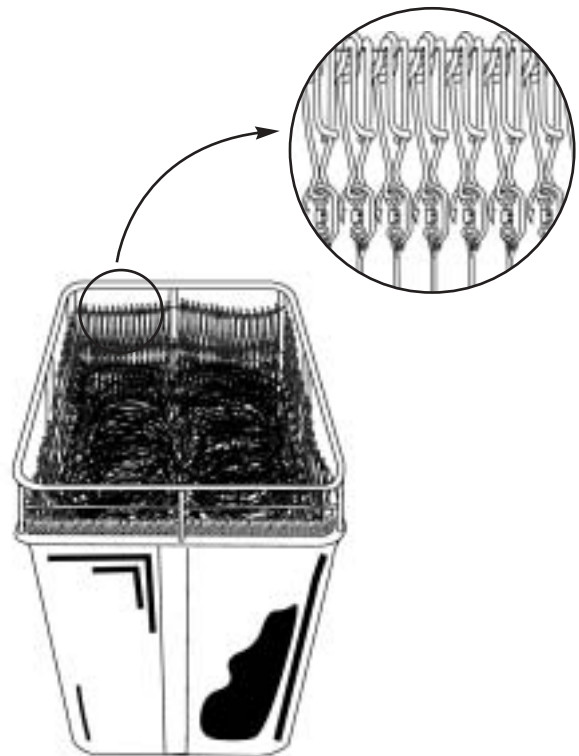

## Floats

Floats for either style of longlining are generally stored in a cage or bin, and transported to the setting area when needed, or back to the cage when the gear is hauled.

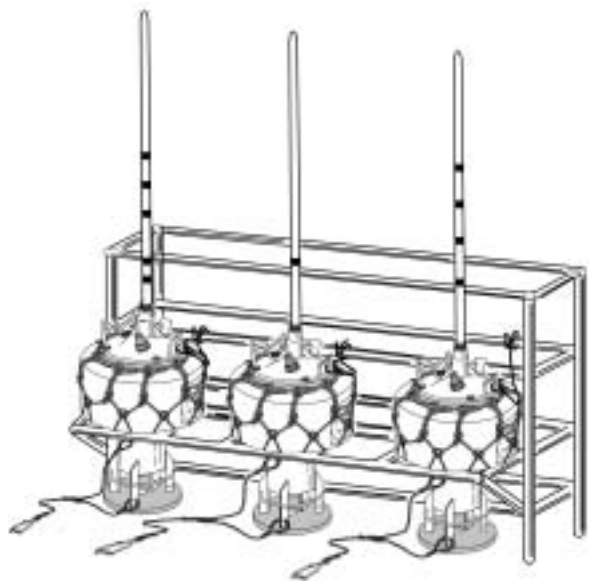

Radio buoys also need to be stowed carefully in an easily accessible area.

## B. HYDRAULICALLY POWERED MACHINERY USED WITH LONGLINE GEAR

Several pieces of hydraulically powered machinery are used with rope gear. Monofilament gear also uses hydraulic machinery.

### Line hauler for traditional rope gear

Traditional Japanese basket gear used no machinery. The line was set and hauled by hand. This changed in 1929, when the first Izui line hauler was developed. The mainline being hauled is fed around the main pulley wheel, with tension applied by a second rubber roller. As the gear is hauled aboard, each basket is coiled and detached from the rest of the line. The branchlines are either left attached to the mainline and guided through the hauler, or detached and stored separately.



### Branchline coiler

If branchlines are detached from rope gear, they can be coiled either by hand, or on a coiling machine. The snap end is placed in the coiling machine, which winds or coils the branchline around it. The coiled branchline is then removed and ready for storage. The same machine can be used for coiling floatlines.

### Automated rope system

The automated rope system uses a continuous mainline. The mainline is hauled using the line hauler, which coils the mainline onto a conveyor. The branchlines are removed and coiled using the branchline coiler. The mainline on the conveyor is transferred via a series of blocks and tubing to the line arranger, which coils the mainline into storage bins.

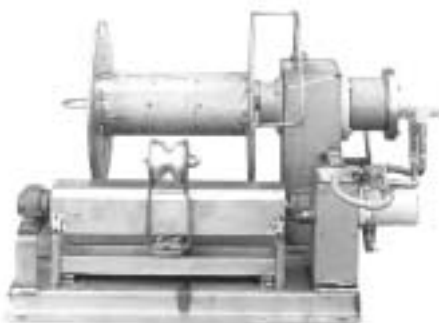
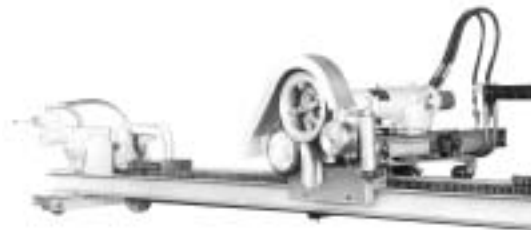

### Japanese Magu reel system

A Japanese Magu reel system has the monofilament mainline hauled with a basket gear line hauler. The branchlines are removed and either coiled by hand or coiled with a branchline coiler. A separate line winding machine winds the mainline onto small removable spools. When each spool is full, it is removed from the winder and stowed, and an empty spool placed on the winder.

### Monofilament reel system

A monofilament reel system uses a hydraulic reel to haul and store the mainline. Blocks are used to guide the line to the reel. The reels come in sizes to suit different size boats. Small reels hold 5 to 10 nm of mainline, large single reels can hold up to 60 nm of mainline, while double reels can hold over 100 nm. Reel capacity is also governed by the diameter (3.0 to 4.5 mm) of the monofilament mainline.



*Small single reel system*

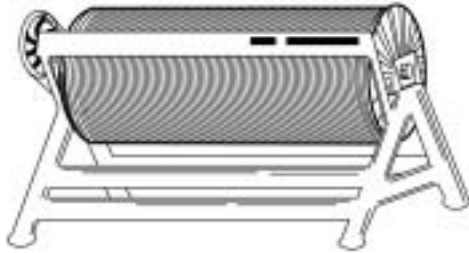

*Large single reel system*

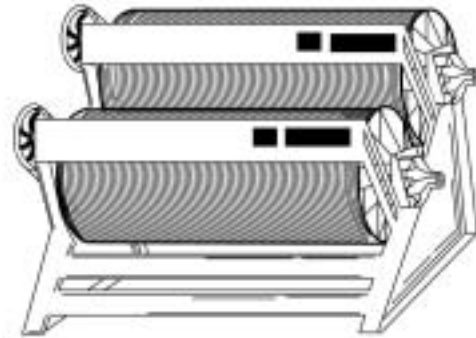

*Double reel system*

### Line setters

Line setters, or shooters, can be used for setting continuous rope or monofilament lines. The line setter deploys the mainline at a predetermined speed, which is faster than the vessel is travelling. This gives the fish master control over depth of the mainline. The branchlines, floats and floatlines are snapped onto the mainline at regular intervals. Line setters are slightly different for rope and monofilament gear, because of the type and size of the mainline.

*Line setter for monofilament gear*



*Line setter for rope gear*



A line setter cannot be used on rope gear where the branchlines are left attached to the mainline, or where the mainline is stored in disconnected section. In these cases, coils of mainline are thrown by hand in such a way that the line is going out at a rate faster than the boat is travelling.

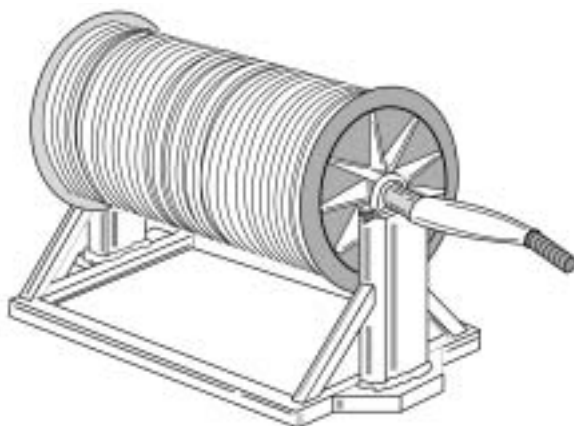

### Manually operated reel

A hand-crank reel can also be used for storing the monofilament mainline. This is sometimes used on small-scale vessels where a short, 5 nm mainline is used. The reel is operated manually by one or two crew for both setting and hauling.



## C. MAINLINE AND BRANCHLINE MATERIALS AND CONNECTION POINTS

Two materials can be used as the mainline for horizontal longlines — tarred rope and monofilament.

### Tarred rope

Basket gear is made from tarred rope. The mainline for basket gear can range from 4 to 8 mm in diameter, but 6.4 mm is the most common. Each basket of gear has the mainline connected to the previous basket using a sheet bend.

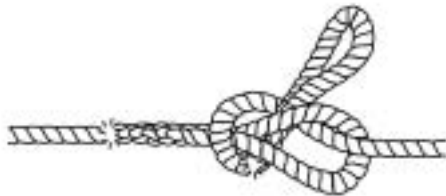

Branchlines are usually spaced about 50 m apart on the mainline, and are attached to specific joints made with two eye splices, using a sheet bend. Floatlines with floats are attached between the baskets, also on joints.



Automated continuous rope gear does not have connection points for the branchlines or floatlines. They are snapped straight onto the mainline at the appropriate intervals.



### Branchline materials

A range of materials can be used for making up branchlines, either on their own or combined through joining the materials together.

### Monofilament

Monofilament mainline ranges from 3.0 to 4.5 mm in diameter. The hydraulically powered reel system is the most common method used with monofilament. The mainline is continuous and the only knots in the line are where the line has been joined after breaking or being cut to remove tangles. Branchlines and floatlines are connected to the mainline with snaps. This allows greater versatility with the gear, as the spacing between branchlines and floatlines can be easily changed.

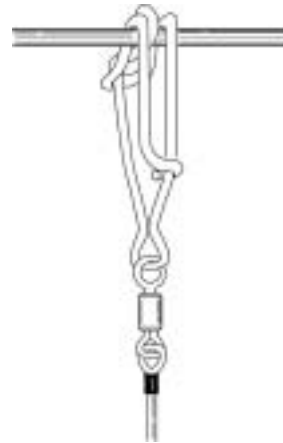

A few fishermen sometimes use two sleeves crimped onto the mainline or a knot to mark off the spot where branchlines and floatlines are to be snapped on a mainline, and to keep the snaps from sliding. Most longline fishermen, however, do not do this, as it is impractical and can be dangerous. Also it is much slower to haul mainline that has sleeves marking the attachment points as the reel has to be stopped for every snap. It is much faster and safer to have the monofilament mainline clear, with no sleeves and few knots, so the branchline and floatline snaps can slide while they are being unsnapped.

Some Asian vessels continue to use a basket-type arrangement, with the branchlines left attached to the monofilament mainline at connection points similar to those used as for rope basket gear. A snap is usually used to connect each basket of monofilament mainline to the next.



### Tarred line

For basket gear, the same tarred line as used for the mainline, usually 6.4 mm diameter, is often used as the top part of a branchline. Connections are usually made with a splice or with a sheet bend. The tarred rope usually comes in standard coils.



### Monofilament line

Clear or coloured monofilament of 1.8 to 2.1 mm is a common material used for branchlines. Per metre, monofilament is the cheapest material to use and is easy to work with. Its elasticity assists in the playing of fish to the boat, although the line is slippery to handle. The monofilament can form part or all of the branchline. Connections are usually made with crimps, although knots can be used. The line comes in loose hanks or skeins or on wooden spools, depending on the quantity being purchased.

### Tarred red polyester line

Tarred red polyester, 3.0 to 3.5 mm in diameter, is popular in some places as a branchline material. Slip knots, splices or crimps can be used for making connections. Tarred red polyester has some advantages over monofilament for branchlines. It is easier to handle because the line does not retain kinks like monofilament does, it sets easier, and it is easier to coil the lines back into the branchline bins. Also, if there is a large fish on the line the fisherman can grip the line better to pull the fish in. Tarred red polyester branchlines do not tangle with the monofilament mainline as much as monofilament branchlines. Tarred red polyester line comes in standard coils.

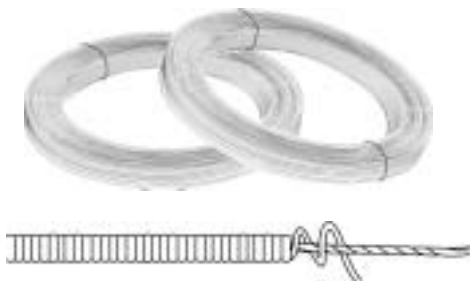

### Sekiyama wire

Sekiyama wire, often called middle wire, is sometimes used as the middle material on branchlines for basket gear. The added weight of this material assists in the sinking of the line, and retaining a deeper set. The centre wire is bound with cotton or synthetic fibre and usually tarred. Connections are made using eye to eye joints, with the eyes usually secured by crimps. Sekiyama wire comes in coils.

### Turimoto galvanised longline wire

Turimoto (No. 27, 3 x 3 strand) galvanised wire is sometimes used for the trace or leader, which connects the hook to the rest of the branchline. It is used as protection from fish with sharp teeth, such as sharks. Connections are made using crimps and the wire comes in coils



### Stainless steel wire

Stainless steel (1.6 mm, 7 x 7 strand) wire is also used as trace or leader material, connecting the hook to the rest of the branchline. This is mainly used with stainless steel hooks to reduce electrolytic reaction. Connections are made with crimps and the wire comes on a spool.

## D. BRANCHLINE HARDWARE

There are several pieces of hardware used in the construction of branchlines, including snaps, swivels, hooks and sleeves.

### Snaps



The swivel snap — often called a clip — is a very important component of a branchline. There are different snaps for rope and monofilament gear, and they should not be interchanged, as they will not work properly. Snaps made for rope gear have a jaw that is too big to grip monofilament mainline. The branchlines will slide freely and cause tangles. Conversely, the jaw of a snap for monofilament gear is too small to work properly on the larger diameter rope gear.

The snaps used on rope gear — often called tuna snaps or shark clips — have a jaw size to grip the 6.4 mm tarred rope. These snaps are also used on the floats, to attach them to the floatline. The most common size is the 3.5 mm (size of wire used) x 125 or 150 mm (length) snap for rope, which can come with or without a No. 2 BL swivel.

A suitable monofilament snap has a tight jaw that grips the monofilament mainline. Monofilament snaps are often called American snaps. The best snaps for 3.0 to 3.5 mm monofilament mainline are the 0.135 x 1/8 inch snaps with 8/0 crane swivel (0.135 is the wire size and 3.0 mm the jaw opening). The jaw opening is the correct size for gripping 3.0 to 3.5 mm monofilament mainline, and the 8/0 swivel is the correct size for 1.8 to 2.1 mm monofilament. Suitable snaps for 3.5 to 4.5 mm mainline are 0.148 x 3/16 inch with an 8/0 crane swivel (0.148 wire size and 4.50 mm jaw opening). The wire is stiffer and the jaw is bigger to accommodate the larger mainline, but the swivel is the same.

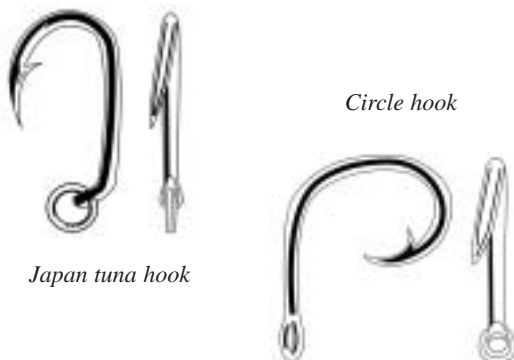
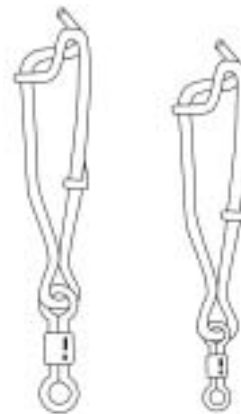

Japan tuna hook

Circle hook

### Hooks

Branchlines can be made with three different types of hook: Japan tuna hook with ring, tuna circle hook, or big-game hook. Japan tuna hooks come in sizes ranging from 3.4 to 4.0 *sun* but 3.6 is the most popular (the number is a Japanese measurement). Tuna circle hooks come in a range of sizes, with the sizes 14/0 to 16/0 the most popular for pelagic longlining.

Big-game hooks (also called ‘J’ hooks), are the most popular hooks when fishing for swordfish. Sizes are usually 8/0 or 9/0. Japan tuna hooks and tuna circle hooks do not work as well with swordfish. The mouth of the swordfish, particularly the bottom jaw, is soft compared to other fish, so a larger hook is required.



Game hook

All of these hook types are available in either galvanised steel or stainless steel. Stainless steel hooks last longer than galvanised hooks but are more expensive. Since they last longer, however, they may be less expensive in the long run. One of the problems with galvanised hooks is that when they are hanging in the branchline bin they are in contact with a stainless steel snap. The presence of a dissimilar metal promotes electrolysis and, thus, the hooks rust rapidly. Electrolysis can also occur with hooks where the hook and ring are made of different metals.

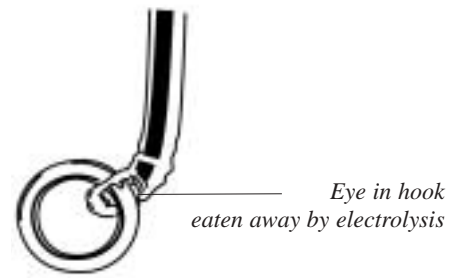

## Swivels

The most common swivels used in branchline construction are the leaded types, which come in 38, 45, 60 and 75 g sizes. The leaded swivels are used to increase the sinking rate of the gear and baited hook, to add weight to keep the branchline deeper in the water, especially in rough weather, or to provide a connection point in the branchline between the main part and the leader. Leaded swivels can be very dangerous, particularly when a large fish or shark stretches the branchline and then throws the hook. The swivel can fly back towards the boat at terrific speed. Fishermen should never stand in direct line with a stretched branchline.



Other swivels can be used in the construction of branchlines, although they do not have the weight of the leaded swivel. Box and BL swivels can be used on rope gear, both in the mainline and in the construction of branchlines. For monofilament branchlines, crane or torpedo swivels can be used.



BL

Crane

Torpedo

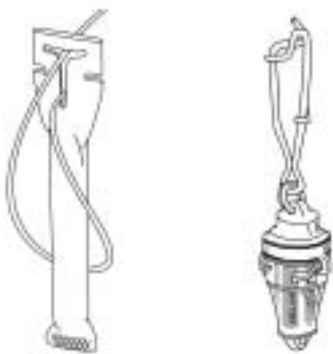

## Lightsticks

Lightsticks are used in the swordfish fishery to attract the fish to the baited hook. Disposable lightsticks rely on a chemical reaction that emits light for 8 to 12 hours. An alternative to the chemical lightstick is a battery operated pressure light that can be used for many days before changing the batteries. Both devices are effective with swordfish and bigeye and come in a range of colours. Disposable lightsticks should not be discarded at sea.

## Glow beads

Glow beads are luminescent beads, which are sometimes used on branchlines just above the hook. The theory is that the beads, being luminescent, will help to attract fish to the baited hook, much the same as a lightstick does. Some fishermen claim that glow beads attract some bycatch species, such as snake mackerel. In any event, they are not widely used.

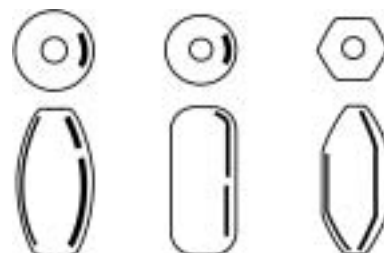

## E. MAKING UP BRANGLINES

Making up branchlines is easy if you have the correct components, materials and equipment. Branchlines can be simple in their construction, with just a length of monofilament joining the hook to the swivel snap, or more complicated with up to three materials used between the hook and swivel snap. The branchlines described below are a selection of only the most common designs, as there are many configurations that can be used.

It should be noted that most crimped connections made in the construction of branchlines have loop protectors (Chapter 1 H) over the end of the line.

### Simple monofilament branchline

The simplest branchline has a swivel snap of the appropriate size connected to 10 to 15 m of 1.8 to 2.1 mm monofilament, with a hook crimped to the other end (a).

### Monofilament branchline with leaded swivel

A leaded swivel can be added to the simple monofilament branchline, by crimping it into the line, 0.5 to 2 m above the hook (b).

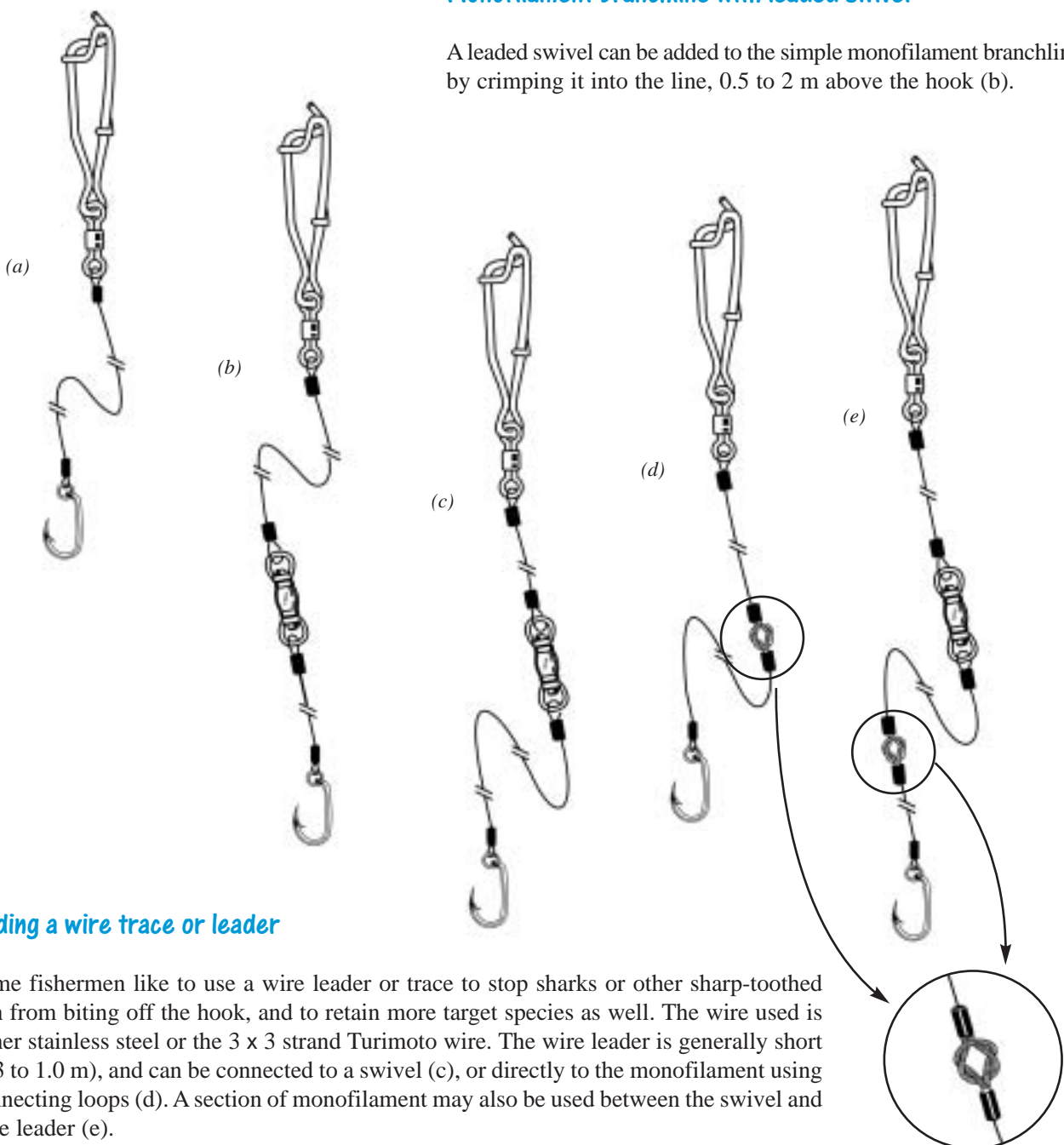

### Adding a wire trace or leader

Some fishermen like to use a wire leader or trace to stop sharks or other sharp-toothed fish from biting off the hook, and to retain more target species as well. The wire used is either stainless steel or the 3 x 3 strand Turimoto wire. The wire leader is generally short (0.3 to 1.0 m), and can be connected to a swivel (c), or directly to the monofilament using connecting loops (d). A section of monofilament may also be used between the swivel and wire leader (e).

### Red polyester branchline

Red polyester line can be used instead of monofilament (10 to 15 m in length), although this material is not connected directly to the hook as it chafes easily. Therefore, a swivel is generally used from 0.5 to 2.0 m above the hook. There may be a wire leader, monofilament or a combination of the two between the hook and swivel. A slip knot, crimp or splice is used to connect the red line to the swivel snap and swivel.

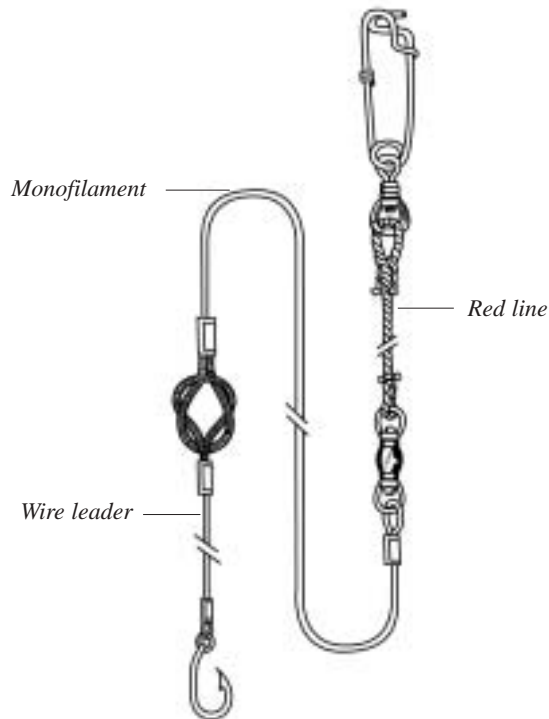

### Tarred rope combination branchline

Tarred rope combination branchlines are mainly used with basket or tarred rope gear, and consist of three or four materials joined together. The branchlines are longer, from 20 to 35 m in length overall. The snap is spliced onto one end of the tarred line (10 to 20 m long), with a leaded, box or BL-type swivel spliced onto the other end. A short piece of tarred line (0.5 m) is spliced to the other side of the swivel, with this line ending in a back splice.

The second section (10 to 20 m long) can either be red polyester line, Sekiyama middle wire or monofilament. The second section has a loop with loop protector on each end, with the loops usually secured by crimps. This section is then connected to the loose end by passing one loop through the other and passing the line through the loop, or through using a sheet bend. The idea of the connections is to allow the branchline to be disconnected easily when the gear is tangled or damaged.

The third section can be a wire leader or monofilament, with a loop and loop protector on one end and the other crimped to the hook. If a fourth section is used, this is usually a wire leader, which would be connected to the monofilament by loops, and the hook secured by a crimp.

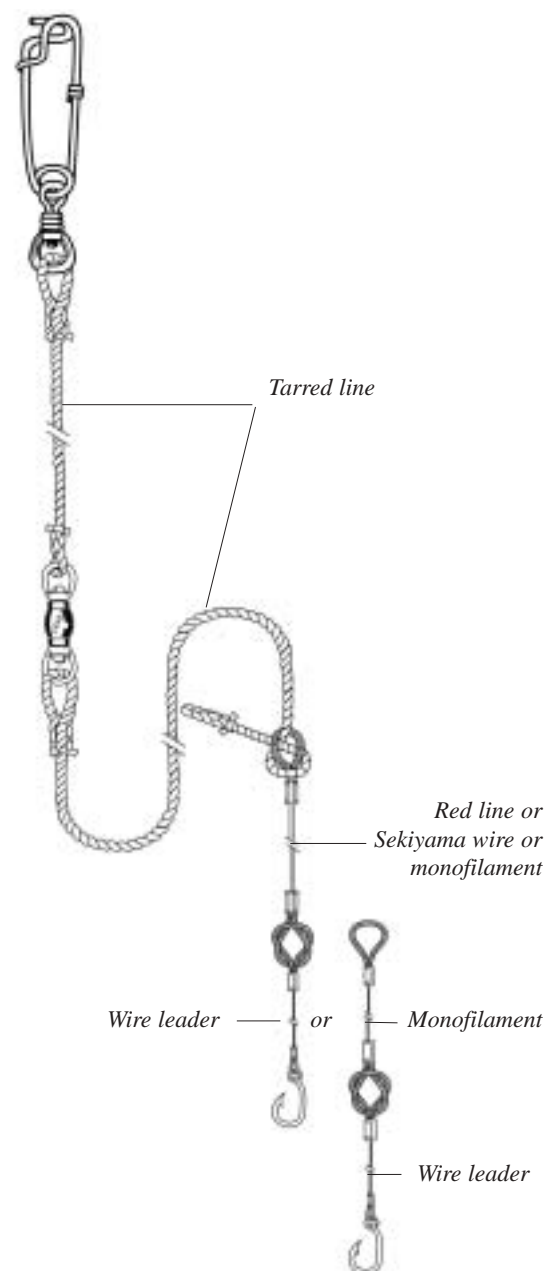

## F. FLOATS, FLAGPOLES AND FLOATLINES

There are several different types of floats used in longline fishing including glass floats, hard plastic floats, inflatable buoys, bullet buoys, and solid foam floats. The most popular floats for monofilament longline fishing are hard plastic floats that range from 165 to 360 mm in diameter. These floats usually have one or two ears — eyes for attaching line — and are ribbed on the outside so they pull through the water easily. Glass floats were popular years ago with Japanese basket gear. Glass floats need to have a net made from tarred rope, as they do not have attachment ears and they are easily broken. Hard plastic floats often have tarred rope netting around them as well. Inflatable floats and foam floats are not very good for tuna longlines as they are compressible and could collapse if a fish drags them down deep. Foam floats and bullet buoys are often used on swordfish longlines, however. Plastic floats for tuna longlines should be pressure rated down to 200 to 300 m.

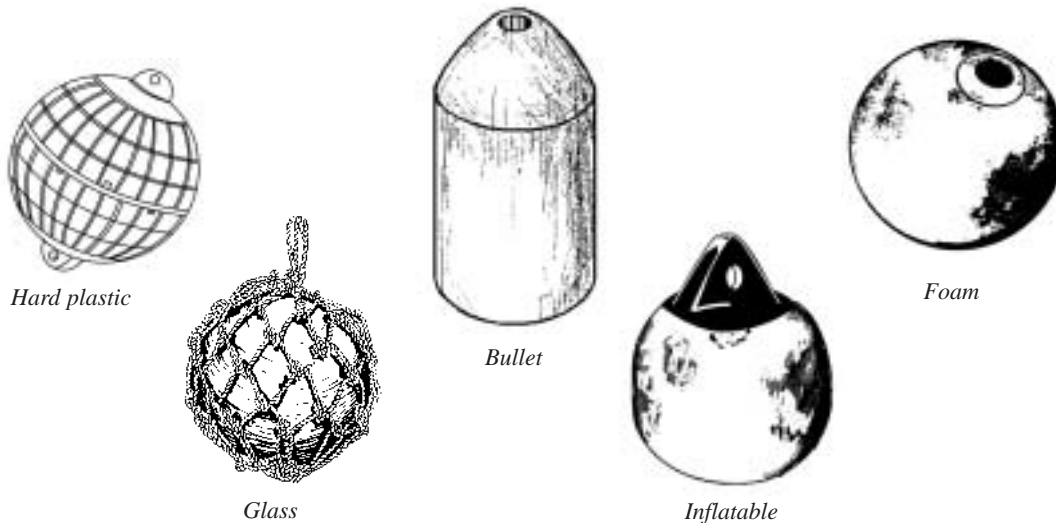

Floats are usually attached to the floatline with a swivel snap that is spliced onto a short length of 6.4 mm tarred line, 1 m long. The swivel snap is attached with a tight eye splice that goes through the eye of the swivel. The other end of the line has an eye splice 15 cm long. When the splices are done the line should be about 75 cm long.

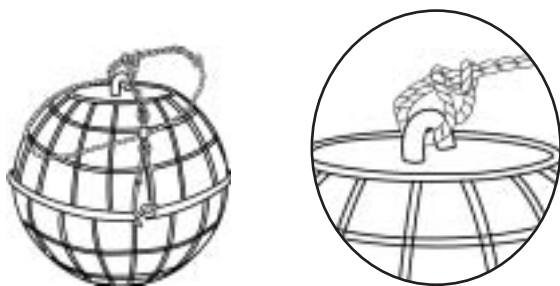
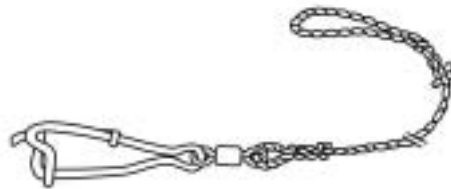

A good way to attach the short line to the float is to run the eye splice through the ear, double the eye over, then run the end with the snap through the double loop. The result is a knot that will tighten up on the standing part of the rope and will not move on the ear of the float. This knot will not chaff through.

If the eye splice is put through the ear and just looped back over the standing part of the line, the connection will be loose and eventually the line will wear through.

Reflective tape should be stuck onto all plastic floats so they can be seen at night. Metal reflective plates or tubes or lights can also be attached to floats. One type of float comes with a threaded hole in the top, where a strobe light can be screwed in.

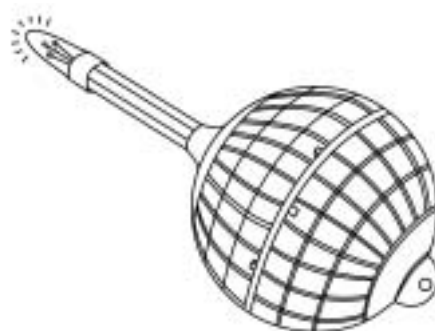

## Flagpoles

Flagpoles are used to add height to a flag or radar reflector to make it easier to locate. Some floats come with a hole through the centre, so a pole (bamboo, fibreglass or aluminium) can be passed through and secured, with a weight on the bottom and the flag (a), light and/or radar reflector mounted on top or lashed to the upper part of the pole.

When using a standard longline float, there are two common ways to secure the pole. First, the pole is lashed to the float with around one-third of the pole below and two-thirds above the float. A weight or steel rebar is lashed to the bottom part of the pole (b), with a flag and/or reflector on the top, and possibly a strobe light for night use.

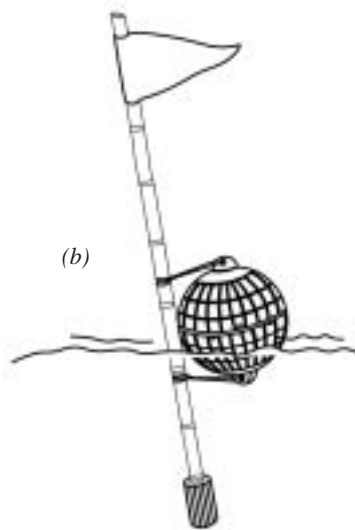
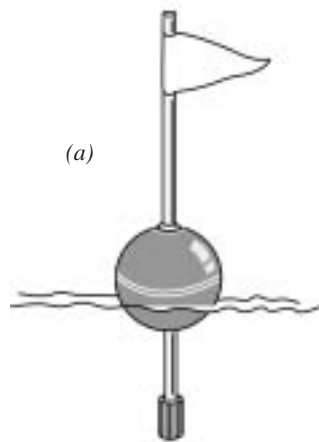

The second method is to have the flagpole separate from the float, just attached to it. In this case, the pole is weighted on the bottom and a flag placed on the top. A short piece of tarred line is attached to the pole so that it can be attached to the float either by a snap or a sheet bend. The pole sits beside the float in the water with the weight keeping the pole upright (c). This allows the flagpoles to be stored separately, plus it allows the floats to be used for other purposes as well.

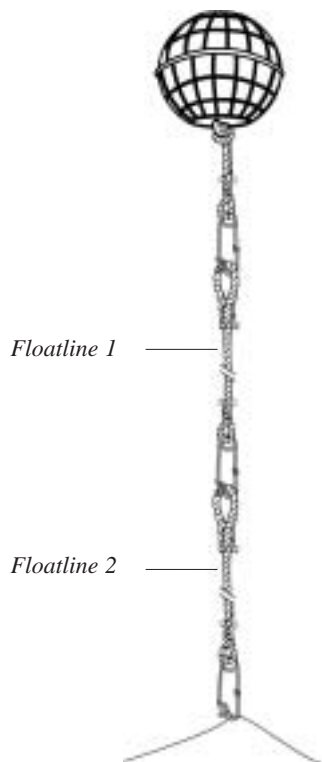
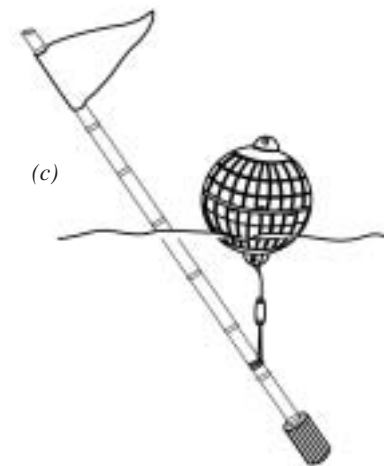

## Floatlines

Floatlines are usually made from black or red vinyl tarred line. The average diameter of floatlines is 6.4 mm but rope slightly smaller or larger will do. Polypropylene rope, or rope made from other floating material, is not a good choice as it will tend to float the entire mainline to the surface, away from the target fish, which are down deep. Floatlines can range from 10 to 40 m or more in length, depending on target species. For tuna, average floatlines would be about 30 m long, while for broadbill swordfish, floatlines may range from 10 to 20 m. The floatline has an eye splice in one end for attaching to the float, and a swivel snap on the other for attaching to the mainline. It is made exactly like the short line on the float except that the line is much longer. Floatlines can also be snapped together to make longer floatlines.

As an alternative, floatlines can be made from monofilament mainline using crimps to form the eyes and to attach the snaps. Some longline boats use small hand operated drums, called leadercarts, to haul and store monofilament floatlines.



## G. RADIO BUOYS

Radio buoys and radio direction finders (RDF) allow longline fishermen to have a more relaxed break while the line is soaking. Radio buoys give out signals that are picked up by the RDF on the fishing boat from as far away as 35 nm, so the fishermen can sleep while the line is soaking, knowing that they will be able to find the line later.

Radio buoys require special rigging and special maintenance. Radio buoys usually come with a flotation collar made of canvas covered foam. The collar is usually attached to the body of the buoy with a shoelace-like cord, which is not very durable. If the collar is lost the buoy will sink and likely implode under pressure and be destroyed. A simple way to prevent the collar from coming off is to tie a net around it similar to the tarred rope net tied around glass floats. Also, the flotation of the collar is sufficient only for floating the radio buoy so another float must be attached to the line close to the radio buoy.

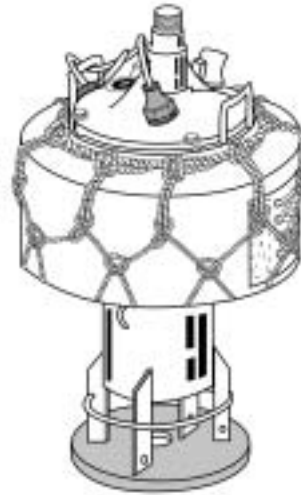

*Radio buoy with netting*

Another component that is necessary on a radio buoy is a strong bridle. The bridle can be made of heavier rope than the floatlines, such as 12 mm three-strand polypropylene, but 6.4 mm tarred rope will do. The bridle should be attached to two different places on the radio buoy. There are padeyes or rings on the buoy for attaching the bridle. Short pieces of plastic hose should be slipped over the rope before the eye splices are made. This prevents chaffing. A heavy-duty longline snap should be attached to the end of the bridle for attachment to the floatline.

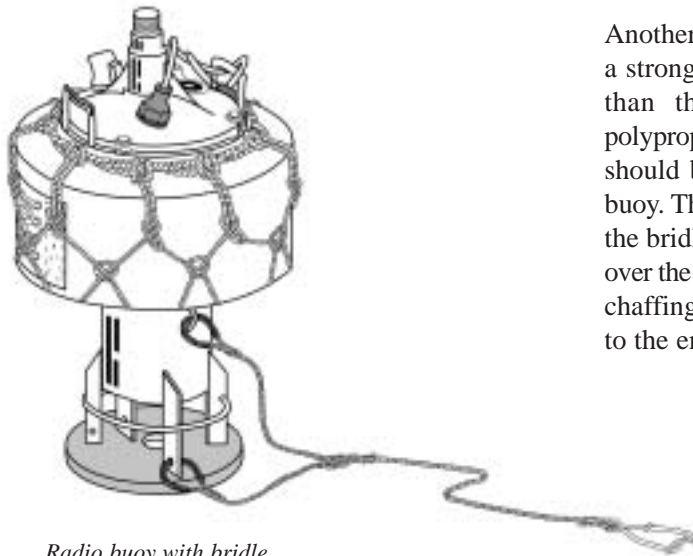

*Radio buoy with bridle*

Finally, two small tie-downs made from tarred rope should be attached to the handles of the radio buoy. On board, the radio buoy should always be secured to the rail or some other spot on the deck so that it cannot tip over. As soon as the radio buoy is recovered from the sea, it should be turned off. The switch should never be turned to the on or test position unless the antenna and antenna wire are connected to the transmitter.

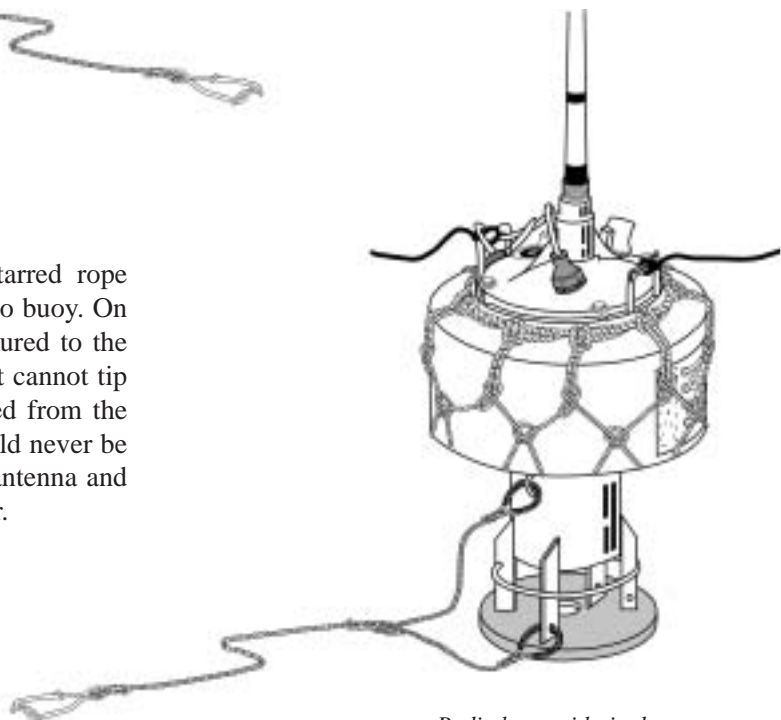

*Radio buoy with tie-downs*

Radio buoys are powered by batteries that come as a canister or as a battery pack with up to 36 D-cell torch batteries. The D-cell packs are probably the best for the Pacific Islands as D-cells are readily available almost anywhere, and they are less expensive than the imported canister packs. When the signal from the radio buoy weakens it is time to change the batteries. Whenever this is done, the radio buoy should also be checked out. Any moisture inside the cylinder holding the battery pack and transmitter should be removed.

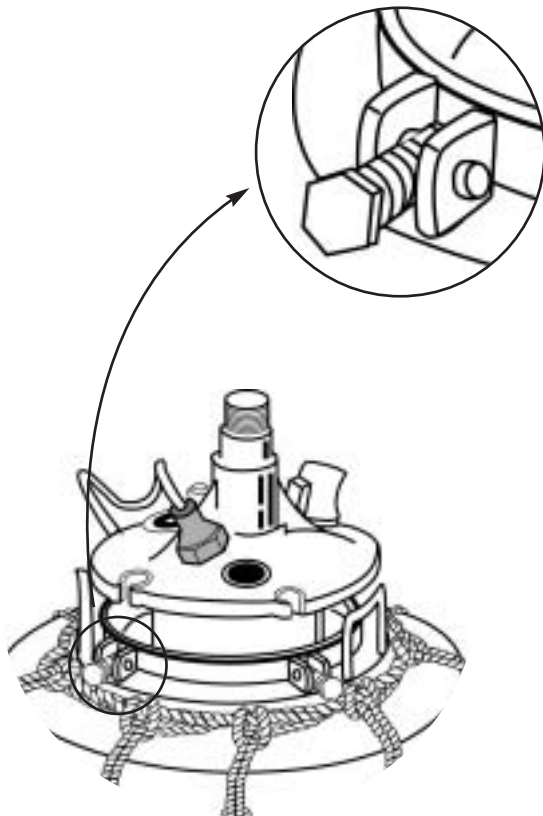

Special select call radio buoys (Sel-Call) are available that give out a signal only when they are called. When these buoys are used, other boats cannot eavesdrop on the signal and figure out where the boat is fishing. They are more expensive than regular radio buoys and another piece of equipment is needed, the radio that calls the buoy. There are also RDF and radio buoy systems that provide GPS positions and sea surface temperature.



The inside of the cylinder, the battery pack, all terminals, and the transmitter should be sprayed with a light coating of silicone spray. The O-ring seal on the lid of the cylinder should be sprayed with silicone or, better yet, coated with silicone grease. The dogging bolts that seal the cover of the transmitter should also be sprayed with silicone spray. All joints on the antenna should be sprayed with silicone and tightened. They should also be wrapped in plastic electrician's tape so they cannot work loose. If a flag is attached to the antenna, care must be taken not to cover the antenna tip. This is where the signal is transmitted from. If it is covered or damaged the radio buoy may not work.

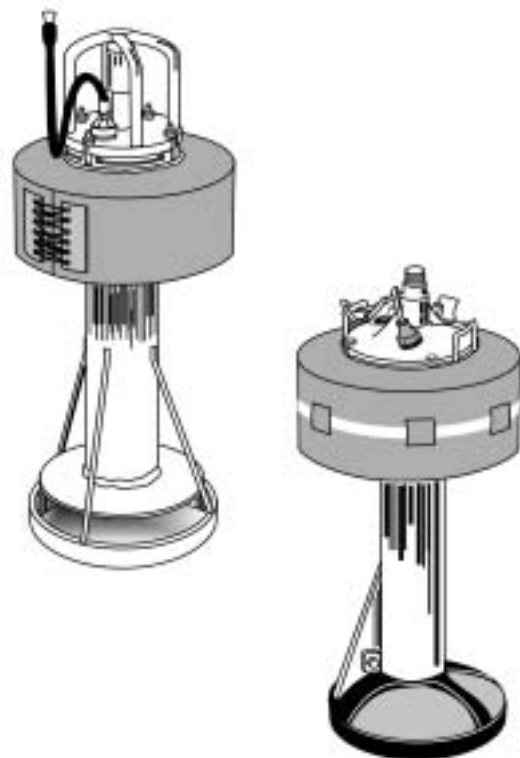

## H. VESSEL ELECTRONICS

The following electronic appliances are essential to safe navigation and successful longline fishing, highly recommended, or optional. A prudent mariner, however, will not depend solely on electronic aids for safe navigation. He will always verify position, course, and speed with a magnetic compass, paper charts, and local knowledge; and will always maintain a proper lookout in the wheelhouse.

### Essential electronic equipment

**GPS — Global Positioning System receiver:** gives vessel position in latitude and longitude at intervals of every second, accurate to within about 30 m. A GPS navigator is essential for both longline fishing and general navigation.



**Radar:** is essential for safe navigation, especially in areas where there are abundant reefs or where there may be other vessels. If fishing is done within radar range of shore, radar can be used to plot positions of a longline set. A radar unit with a 24 nm range should be sufficient for a small-scale longline vessel, while 36 nm range should be sufficient for a medium-scale longline vessel.

**SSB — single sideband, or HF — high frequency radio:** is essential for communication both for general navigation (ship-to-ship and ship-to-shore) and for fishing. Longline vessels can share catch and fish location information with each other, and can relay catch data and ETA (estimated time of arrival) to their agent or manager on shore. With an export fishery that depends on air links to Japan and other international markets, good communications are critical. Digital SSB radios with LCD readout are best. The SSB should be capable of operating in all ITU modes and on all ITU frequencies.



**VHF — very high frequency radio:** provides short range radio communications, essential for communicating with harbour authorities, with agents, and with other vessels in crossing situations to avoid collisions.

**SST — sea surface temperature monitor:** SST data are important for longline fishing, as both tunas and broadbill swordfish are often associated with temperature fronts (Chapter 3 C). The best SST monitors have shear alarms that give off an audible signal when the temperature rises or falls significantly.



### Highly recommended electronic equipment

**Autopilot:** is helpful for setting the gear as it relieves one man from steering the vessel. Often this man is needed on deck to help with the set. An autopilot also gives a much straighter set than hand steering would. Some autopilots can also be used during hauling. The best autopilots for longline fishing have dial control knobs for course changes, rather than touch pads, and remote controls with dial control knobs.



**Colour plotter:** can be separate from the GPS or can have a built in GPS receiver. A plotter is used for general navigation, but can be very useful for longline fishing as it gives more detailed information about the longline set. The plotter draws a picture or plot of how the line was set and how it was hauled. A comparison of the set and haul plots gives the skipper important information about set and drift — current direction and speed — and the presence of eddies or convergences (Chapter 3 C). Events such as fish catches can be entered on the plotter easily by pushing the 'event' or marker button. Geographical features such as reefs can also be entered onto the plotter. Many modern plotters include chart cards with global coverage. Some chart cards show bathymetry, reefs, and navigational aids as well as geographical features.

**Colour echo sounder:** is important for navigation, especially in strange waters when entering harbours or going through passes in outer reefs. Another function of a sounder is its ability to 'find' fish. In fact, sounders are often called 'fish finders'. This is not important so much for locating schools of tuna as for locating bait that tuna or swordfish may be feeding on. Some sounders have the capability of reading the depth of the thermocline (Chapter 3 E). Some are equipped with sea surface temperature sensors and are able to display this information graphically on a time line. The most suitable sounder for a longline vessel would be a 1.0 kW model with a 50 kHz transducer (depth rating to at least 1000 m) and graphic SST function.



**RDF — radio direction finder and radio buoys** (Chapter 2 G): are not essential items as longliners operated throughout the world for years using only lights and coloured flags on bamboo poles to locate their lines. Besides finding radio buoys, RDFs can also be useful as navigation aids. Most RDFs are capable of giving a bearing to land based airport beacons and to AM radio stations. More sophisticated RDFs can be used to eavesdrop on other longliners to gain fishing information.

**Weather facsimile receiver, or weather fax:** receives weather information that is faxed worldwide on a number of frequencies. The information comes as synoptic weather maps (Chapter 1 L), which are much more detailed than reports given on HF radio or on Inmarsat-C systems. Remote sensing data, such as SST data, can also be received on a weather fax. A weather fax is a valuable item on any longliner operating in the cyclone belt.



### Optional electronic equipment

**BTG — Bathythermograph:** is an instrument that measures temperature against depth. It is useful for finding the depth of the thermocline and for graphing temperature profiles (Chapter 3 E). There are reusable bathythermographs as well as portable disposable bathythermographs, which are called expendable bathythermographs or XBT.

**Doppler current meters** — also called acoustic doppler current profilers, or ADCPs: are capable of showing currents not only at the surface but also at a variety of depths. Up to three layers of water can be monitored even while the vessel is underway. This information could be important in deciding what depth and direction to set the longline.

**Inmarsat systems:** allow ship-to-ship and ship-to-shore satellite communication. Inmarsat-C does this in a fax or email mode. Inmarsat-A has voice communication capabilities as well, but is too expensive for most longline operations. No one can eavesdrop on a fax transmission, so two boats can share confidential fishing information with each other. Weather and distress messages are also transmitted on Inmarsat-C.



**PC — personal computer:** is becoming more and more of a necessity on fishing boats. A PC is necessary for two-way communications on Inmarsat-C using software such as Galaxy; and software is available with charts for course plotting, for monitoring weather, for getting real-time satellite oceanographic data such as sea surface temperatures and weather, and for managing the business of a fishing boat.

**TDR — temperature-depth recorders:** are very small reusable BTGs that can be attached to branchlines to monitor depth and temperature at set intervals along the longline set. They can also be called temperature profiling probes, or data loggers, or micro-bathythermographs. TDRs record temperature, depth, and time digitally and this data can be downloaded to a PC. They can also double as hook timers as the depth/time function usually shows changes that indicate when a fish was hooked: the depth decreases or increases showing a spike in the graph.

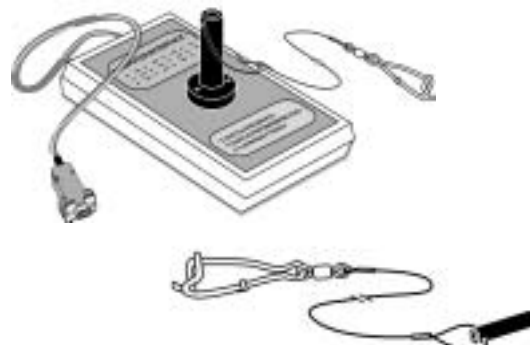

**VMS — vessel monitoring systems:** make use of an on-board transceiver called an automatic location communicator, or ALC. The ALC sends and receives messages via Inmarsat-C to a land base via a land earth station, or LES. The land base can track the position of a fishing boat in real time and can also ascertain if the boat is fishing or not by the signature of the tracks. The shore base can also request a position from a vessel through a polling mechanism at any time, and it is automatically relayed. Governments in the region are implementing VMS regulations, and eventually VMS systems will be required throughout the region.

Aside from position monitoring, the ALC can be used for catch reporting, secure communications, and for safety. The ALC can give out a distress signal that identifies the boat and gives its position.



**GMDSS — Global Maritime Distress and Safety System:** is a system initiated by the International Maritime Organization (IMO) as part of the SOLAS Convention. GMDSS is designed to automate radio distress calls, eliminating the need for manual watchkeeping of distress channels. GMDSS uses a combination of VHF and HF radios, satellites, SARTs, and DSC, or digital selective calling. GMDSS can be very expensive as the system requires back-ups, or duplicates, of almost every device. The system has some inherent flaws and has been subject to numerous false alerts, especially with the DSC. Even though GMDSS became mandatory for SOLAS Convention vessels after 1 February 1999, IMO has recommended that vessels retain traditional radio communications, using VHF and HF radios for distress calling, until the year 2005.

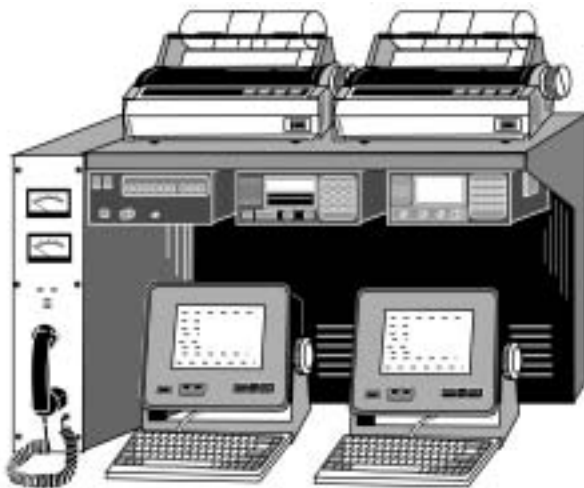

In any event, GMDSS applies only to commercial SOLAS Convention vessels over 300 GRT on international voyages. Commercial vessels under 300 GRT or those over 300 GRT on domestic voyages are subject to requirements of the flag state. Some flag states have incorporated GMDSS into their domestic regulations; other states have not. Most domestic long-line vessels operating in the WCPO will probably not be required to carry GMDSS equipment in the near future.

## Maintenance

All electronic devices on a fishing boat require special care and maintenance. They should be kept dry and out of direct sunlight or other sources of heat. Sea spray should never be allowed to come in contact with electronics. If this does happen, however, the equipment should be cleaned and dried and then sprayed with silicone spray. All connections should be sprayed with silicone spray periodically. Most electronic devices will last longer if they are not switched on and off unnecessarily. Electronic devices that do not consume lots of power, such as radios and GPS, should be switched on at the beginning of each trip and switched off after the boat returns to port. Other devices, such as radar and echo sounders, can often be left on but in a standby mode.

## I. VESSEL HYDRAULICS

Most longline systems are powered by hydraulics. Hydraulic systems convert mechanical energy into fluid energy and then back into mechanical energy. Hydraulic systems are a good way of moving power around on the deck of a boat. Workers do not have to worry about electric shock or getting caught on a shaft or pulley, although there are risks involved with hydraulic components. Other advantages of using hydraulic systems are: hydraulic motors can be started, stopped, or reversed under full load; hydraulic motors have high power for their size; and it is easy to regulate the power and speed of a hydraulic motor.

### Basics

A hydraulic system consists of a tank or reservoir with hydraulic fluid, suction hose, pump, pressure hose, pressure relief valve, flow regulator, check valve, selector valve, control valve, motor or ram, return hose, cooling system and a filter. The pump is usually a vane pump that runs off the main engine, although it can be driven by an electric motor. If it is run off the main engine or an auxiliary engine it must be linked with pulleys and belts, gears, or a power take-off unit (PTO). If the pump is belt driven there is usually a mechanical or electrical clutch so the pump can be disengaged for emergency stops. PTOs usually have built-in clutches. A switch or lever to disengage the clutch for emergency stops is usually mounted somewhere in the wheelhouse or on an outside station on deck.

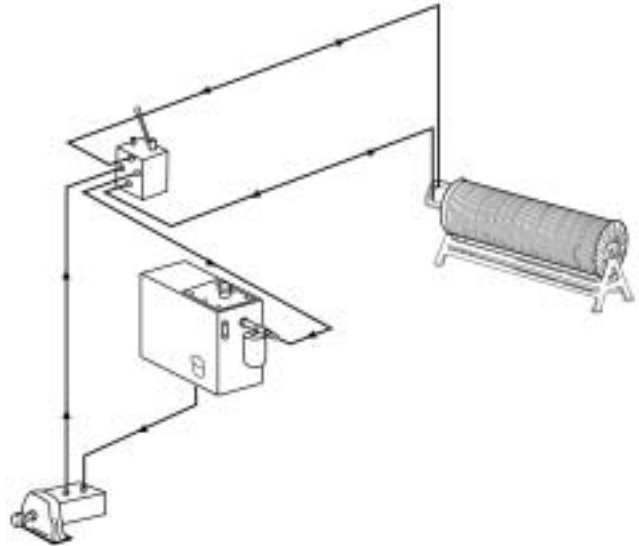

Hydraulic systems are rated by volume and pressure of fluid available for work. A typical longline system requires 15 gallons per minute (GPM) at 1200 PSI. The important thing is that the ratings of the pump match the requirements of the hydraulic motors or rams.

The pressure relief valve on a hydraulic longline system should be set so that it opens before the breaking strength of the mainline is reached. Even though a system has 1200 PSI of power available it should be adjusted to cut out at some lower pressure. The pressure relief valve can be adjusted by putting a load on the line at full power. The valve adjustment screw should be adjusted so that fluid dumps back into the return line or tank before the line breaks — actually just before the system reaches full power. This will save the mainline from breaking if it becomes tangled during hauling or if a large fish runs with the line.

Hydraulic rams or cylinders can be used for steering or on equipment such as a crane. Hydraulic motors on a longline boat are used for anchor winches, boom winches, capstans, line haulers, longline reels, longline setters, and line arrangers. One hydraulic pump can power more than one piece of equipment on a fishing boat, but usually not at the same time. The circuit of hoses may have one or more selector valves that divert the fluid from one system to another. The hydraulic motors used on large monofilament longline reels are usually radial piston motors while the hydraulic motors used on line setters are usually vane motors or linear piston motors. Radial piston motors usually need to have a case drain line that bleeds pressure from the motor case back into the return line.

### Repairs and maintenance

Hydraulic oil must be clean and moisture free. Dirt and water can cause equipment failure. The best way to ensure that the hydraulic oil is clean is to change the filter on a regular basis. Inspection of the oil and filter should be a good indicator of whether the filter needs to be changed. If the oil is very dirty, then it should be changed, too. The entire system should be inspected regularly, including all hose ends and fittings, for corrosion and wear.

Hydraulic hoses and fittings on fishing boats often wear out or break, causing hydraulic oil to leak out on deck or into the bilge or lazarette. If the leak is noticed right away and the hydraulic system is stopped, then repairs can be made and the tank can be topped off with reserve hydraulic fluid.

Hoses and fittings on deck are subject to more wear and corrosion than elsewhere on a boat. The most common hydraulic repair at sea is to fix or replace a leaking hose. If a hydraulic hose springs a leak, it is time to replace the hose. However, if there are no spare hoses on board, a temporary repair can be done with reusable fittings. Two reusable female swivel hose-end fittings and a male adapter are needed. The easiest hoses to repair are non-skive hoses. This means that the hose does not have to be trimmed (skived). A hacksaw and two adjustable wrenches, or wrench and a vice, are the only tools needed.

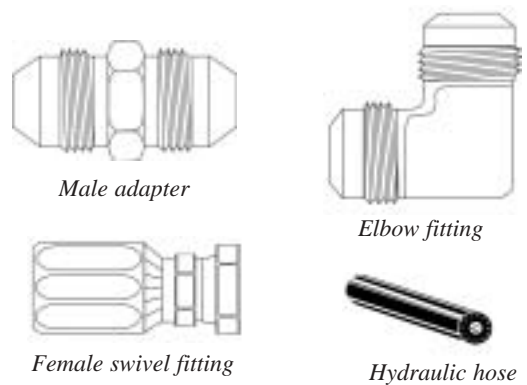

First, the hose is cut with the hacksaw on either side of the damaged portion so that there are two clean hose ends with straight 90° cuts. Next, a reusable female swivel fitting is attached to each hose end using the adjustable wrenches. The socket of the reusable fitting is screwed onto the hose first, with a left-hand twist using an adjustable wrench. Next, the tapered nipple of the fitting goes into the socket with a right-hand twist. The socket is held with one adjustable wrench and the tapered nipple is turned with the other adjustable wrench. This is done to both cut hose ends. The two resulting hoses are joined together by tightening the reusable fittings onto the adapter. In effect, the single broken hose becomes two separate good hoses, which are joined to make one.

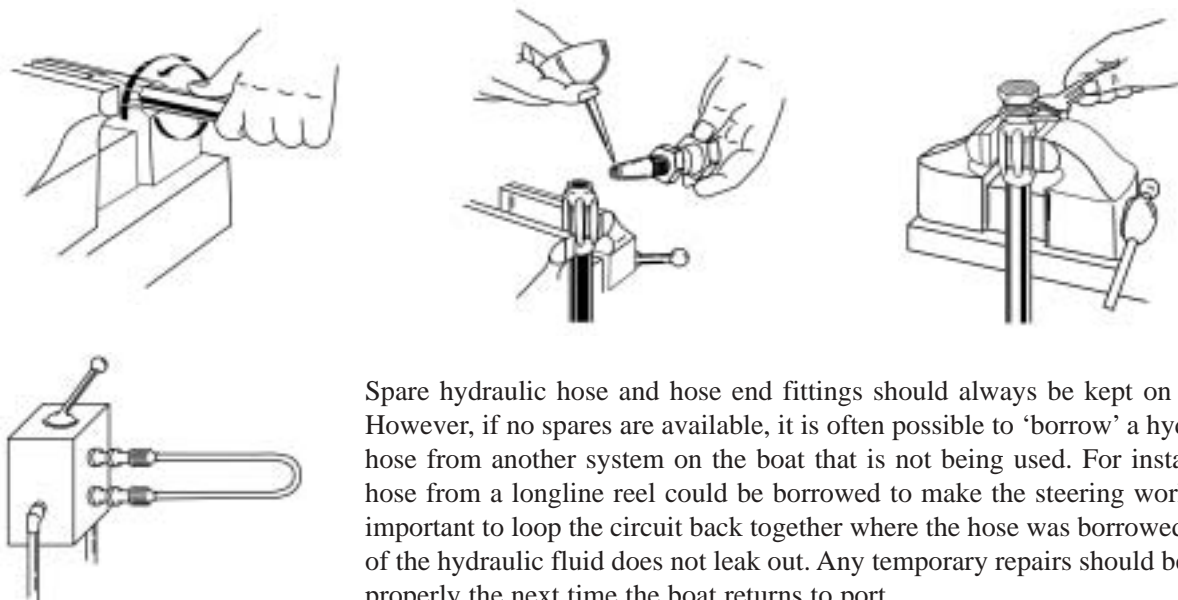

Spare hydraulic hose and hose end fittings should always be kept on board. However, if no spares are available, it is often possible to 'borrow' a hydraulic hose from another system on the boat that is not being used. For instance, a hose from a longline reel could be borrowed to make the steering work. It is important to loop the circuit back together where the hose was borrowed so all of the hydraulic fluid does not leak out. Any temporary repairs should be fixed properly the next time the boat returns to port.

Hydraulic hose ends and fittings that are not made of stainless steel will last longer if they are covered with a protective coating, such as Denso Tape or Soft Seal. Another good way to protect fittings is to spray them with cold galvanise paint. Cold galvanise can also be sprayed on hydraulic motors and valves. Before any part is sprayed with cold galvanise it should be treated. All rust should be chipped away and the part should be brushed with Ospho or some other rust inhibitor that contains phosphoric acid. After the acid reacts with the rust, a white powder forms. This should be brushed away with a wire brush. Lastly, the part is coated with cold galvanise. This process should be repeated regularly, possibly after every trip. Another way to protect hydraulic fittings is to wrap them in old inner tube rubber. On a fishing boat, this is called rubber wrapping. Old automobile inner tubes can be cut into strips about 6 cm wide. These strips can be used to make a watertight wrapping around fittings.

If all of the hydraulic fluid is lost from the system and there is no spare fluid, emergency hydraulic fluid can be made using motor oil and diesel fuel. Motor oil and diesel fuel are mixed in a ratio of about 80 per cent oil to 20 per cent diesel. The hydraulic system should be test run with the makeshift oil. If the hydraulic pump starts to overheat or appears to be running sluggishly, more diesel needs to be added to the mixture. If the hydraulic pump is racing or is not supplying enough power, more motor oil is needed. This makeshift hydraulic fluid should be replaced as soon as the boat returns to port.



## CHAPTER 3

# FISHING OPERATIONS

- A. Preparing for a fishing trip
- B. Deciding where to fish: when leaving port
- C. Deciding where to fish: when arriving at the fishing ground
- D. Deciding where to fish: during the trip
- E. Targeting the gear: the surface layer and the thermocline
- F. Targeting the gear: depth of set
- G. Setting and hauling the gear: general
- H. Setting monofilament gear
- I. Setting rope gear, setting time, data recording and soak time
- J. Some variations on setting
- K. Finding the gear
- L. Hauling basket gear
- M. Hauling monofilament gear
- N. Encountering problems when hauling the gear
- O. Fish on the line

## INTRODUCTION

This chapter describes horizontal tuna longline fishing operations. It covers the steps in deciding where to fish when leaving port, when arriving at the fishing ground, and during the trip. Several sections are devoted to the targeting of the gear, looking at depth of set and the parameters that need to be considered. Setting and hauling the gear are covered in detail, looking at the way both monofilament and rope gear are handled including variations on setting based on oceanic conditions. Common problems encountered in hauling the gear are also described, with solutions presented to assist new entrants to this style of fishing operation.

## A. PREPARING FOR A FISHING TRIP

Preparations for a trip actually begin on the previous trip. Good skippers, engineers, and fish masters will begin making notes while they are still at sea, of what maintenance needs to be done and what equipment and gear needs to be purchased. Essential items can be ordered by radio before returning to port. This will shorten turnaround time and make the operation more viable. In addition to the normal pre-departure checklist (Appendix E), the skipper should have checklists of specific items noted from the previous trip.

### The engine room

Fuel, usually industrial diesel, should be topped up after every trip unless the tanks hold enough fuel for two or more trips. After several trips, the skipper or engineer should know the average daily fuel consumption. Some boats have sight gauges on the fuel tanks or a dipstick, so it is easy to read how much fuel has been used.

If the fuel consumption is not known, it can be roughly calculated using the formula for fuel consumption for a turbo diesel engine running at full RPM: 0.175 litre/HP/h. The actual fuel usage would be less than the calculated fuel consumption because the main engine would not be running at full RPM continuously.

Enough motor oil should be on board to make one oil change on all engines, plus spare oil for topping up the sumps. There should be enough hydraulic fluid to fill the reservoir and system in case all of the fluid is lost, plus some for topping up.

Any engine spares that were used on the previous trip should be replaced. This includes routine items such as oil filters and fuel filters, and parts that are only periodically used such as pump rebuild kits, electric starters, fuel pumps, etc. Spares should also be carried for refrigeration equipment, including refrigerant gas, oil and filters. Spare nuts and bolts, assorted hose and hose clamps, lubricating spray, cleaning rags etc. should also be kept in stock. Lastly, any tools that were lost or broken should be replaced.

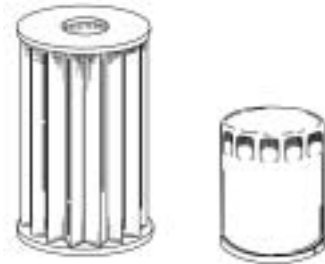

### The wheelhouse

There are not many expendable items in the wheelhouse of a typical longliner. However, there are some things that need to be replaced from time to time. These include: paper for recording echo sounders, for the weather fax receiver, for the printer on the Inmarsat-C receiver and PC; fuses and circuit breakers for all electronic devices; bulbs for all lighting; logbooks, catch report forms, pencils, pens and erasers. All electronics should also be tested before departure. Any medicines or first aid supplies that were used on the previous trip, or those with expired dates, should be replaced to keep a good supply on hand. Recording paper, fuses, first aid supplies, etc. should all be stored in watertight ziplock plastic bags, and labelled with a felt-tip marking pen.

### The deck

The most important items for the deck on a longliner are ice, bait, replacement fishing gear, and spare parts for the fishing equipment. Ice boats and CSW (chilled seawater) boats need to load ice before departure. Usually enough ice is loaded to fill the holds or bins. In some ports there are no shore-side mechanised delivery systems for ice so transport and labour have to be arranged to coincide with ice purchases.

The amount of bait needed for a trip is fairly simple to calculate. Bait usually comes in 10 kg boxes and the number of pieces is usually marked on the outside of the box. A typical box of saury, for example, contains 120 pieces of bait. If ten sets are to be made using 1200 hooks per set, then 100 boxes of bait would be needed (120 pieces x 10 = 1200

pieces x 10 sets = 12,000 pieces or 100 boxes). Some boats take one or two days' extra bait in case they run out or an extra set is made. Bait can be stored in a fish hold on ice or it can be stored frozen. If the bait must be stored on ice in the fish hold, it is a good idea to wrap the bait in a plastic tarp, with a thin layer of ice between each layer of boxes. If there was bait left over from the previous trip then this bait should be loaded last so that it will be used first. If the bait is to be iced, the ice should be delivered before the bait.



Replacement fishing gear consists of hooks, snaps, crimps, loop protectors, monofilament or tarred red line for branchlines, monofilament for the mainline, batteries for the radio buoys and light buoys, light bulbs for light buoys, mutton cloth, and, for swordfish, chemical lightsticks. Something like five to 10 per cent of the branchline gear may be lost each trip on a medium-scale longliner. If 1200 hooks are set each day for 10 sets, for example, then a sufficient amount of hooks, leader material and crimps will be needed to repair 60 to 120 branchlines. A much smaller percentage of snaps and leaded swivels will have been lost, however, and the mainline on the reel is usually only topped up once or twice a year. Radio buoy batteries usually last for several trips but light buoy batteries, unless they are rechargeable, generally need to be replaced each trip.

Spare parts for the reel and line setter are usually kept on board and are used as needed. If any are used they should be replaced before the next trip. Spare longline blocks and longline block bearings are also essential items. Waterproof or high speed water resistant grease cartridges and a grease gun are also essential for lubricating the fairlead shaft and all bearings on the reel, line setter, and longline blocks.

Numerous miscellaneous spares are needed for the deck including: duct tape, silicone spray, buckets, gaff heads, gaff poles, gloves, brushes for cleaning fish, knives, killing spike, meat saw blades, meat hook, ice shovel, deck brushes, detergent and bleach. Some boats provide foul weather gear and gumboots for the crew. Other boats require that each fisherman purchase his own. In any event, it is necessary that each member of the deck crew have a suit of foul weather gear and a pair of gumboots, especially on ice boats. If any of these items are missing they need to be replaced.

### The galley

Longline fishing is hard work and the crews need to be well fed. Providing galley stores for a medium-scale longliner is fairly easy. It is not much different than going to the market for a normal household except it is for all adults and one trip to the store has to last you three or four weeks. If something is forgotten you are out of luck — there are no markets at sea. One easy way to shop is to plan a menu for one week and just multiply everything by three or four, depending on trip length.

Meat should be frozen, but if the boat does not have a freezer, meat can be put in plastic bags and buried in ice in the fish hold, where it will keep for several weeks. Fresh fruit and vegetables can be kept for several weeks if they are properly packed and stowed. One way to ensure that things such as cabbage, lettuce, tomatoes, carrots, and fruit stay fresh is to wrap them in newspaper and store them in a cardboard carton or plastic fish basket in the ice hold, or loosely in a refrigerator. Items such as taro, cassava, potatoes, onions and eggs should be stored in a cool dry place. For longer trips taro can be peeled and frozen. Cassava can be peeled and stored in the ice hold, where it will keep for several weeks. Bread and fresh milk can be stored in the ice hold or freezer. UHT milk or powdered milk is the best choice, as they will keep for several months with no refrigeration.

Besides the normal provisions, a longliner should have emergency rations on hand at all times. The best emergency rations are tinned (canned) foods and dried foods. At least one week's worth of items such as tinned fish, tinned corned beef, tinned spaghetti, tinned fruit, tinned vegetables, rice, biscuits, sugar, coffee, tea, and powdered milk should be stowed in a secure place such as in the skipper's cabin or in a lockable storage cabinet. The emergency rations should only be used if the trip is longer than originally planned for, or if the normal provisions run out or are somehow spoiled. Any of these items that are used on a trip should be replaced before the next trip. The emergency rations should be checked periodically so that expiry dates on tins and packages are not exceeded. When the expiry dates are approaching, the tins or packages should be cycled into the everyday provisions and new emergency provisions should be purchased.

If the boat has a propane gas stove then the gas bottle needs to be checked and filled if necessary. If the boat has an electric stove then at least one spare electrical element for the stove should be on hand.

### Fresh water

Prior to departure, the fresh water tank should be filled up. In addition, emergency water should be stored somewhere on deck in plastic jugs. These jugs should be watertight and should be about 85 per cent full. The air space will allow them to float if needed in an emergency.

## B. DECIDING WHERE TO FISH: WHEN LEAVING PORT

Once a longliner is loaded and on its way, the skipper has to make some important decisions. At the beginning of a trip he has to decide which direction to go. This decision is usually based on where he fished during the last trip, where the rest of the fleet is fishing, and where there were catches for the same season in the past. Talking to others both on shore and on the radio can yield valuable information. He may also rely to a certain degree on remote sensing data, or satellite imagery, for SST, sea surface colour, or sea surface height.

Note that major shipping lanes are usually avoided, and closed fishing areas should always be avoided.

### Talking to other fishermen

The best source of information about how, when, and where to catch tuna or swordfish is by talking to other longline fishermen. Fisheries scientists learn about fish stocks and fish behaviour by analysing data from satellites, research cruises, and logsheets from fishing boats. The conclusions they come to usually have global or regional significance and may be useful to a commercial fisherman, but only in a general way.

Fishermen who have spent years at sea have learned a great deal about the fish they catch, about the sea and the weather, and about fishing boats and gear — by being directly involved. Fishermen can be independent and are often reluctant to ask others for advice; and some may be reluctant to share their knowledge. However, many fishermen love to chat to anyone who will listen. Talking to other fishermen, either in port or on the radio, is an important part of a good fishing strategy. It also increases safety to know where the other boats are and how they are doing.

Fleet fishing is probably one of the best ways to find fish. Five or six boats searching for fish are much more effective than one boat. Most successful longline operations fish in a fleet. They stay in daily contact and share position and catch information. Several longliners travelling in a general area can find a temperature front (see next section) and chart its boundaries. They can also monitor the movements of fish as catches are compared against positions. Important information such as local weather anomalies and whale sightings can also be shared. Safety is also increased when vessels operate as a fleet. Some fleets report daily to a land base by SSB radio or Inmarsat-C, giving catch data and position. The fleet manager on shore then passes information on to other boats in the fleet, especially those just leaving port.

### The moon

Moon phases affect longline fishing. It has been documented that swordfish catches are better on the full moon. Swordfish longliners try to time their departures and travel so that they will be fishing around the full moon. Bigeye catches are slightly better during full moons and bigeye can sometimes be caught in abundance on a full moon. When tuna are targeted, however, the phase of the moon is not generally considered, as the trips are short compared to swordfish trips, and tuna boats do not travel as far as swordfish boats. Tuna longliners usually attempt to keep turnaround time between trips to a minimum, departing when the boat is ready to go, and not on the basis of the moon phase. When the moon is full while a tuna boat is out fishing, however, it may be a good idea not to make any moves but to stay in that area and fish. Tuna usually come closer to the surface during a full moon, so the line should be set shallower and hauling should start later. Some fishermen will say, however, that the new moon is the best time to fish for tuna.

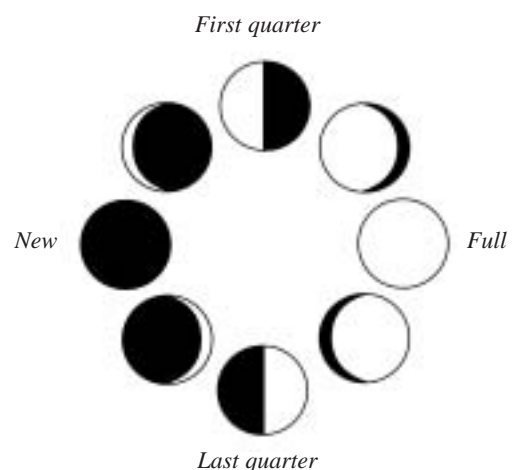

### General weather forecast or prediction

The weather prognosis chart should be examined and taken into consideration when setting out on a longline trip. If the prediction is for foul weather then the boat should travel in a direction to avoid the weather or stay close to a safe haven until the foul weather passes.

## New developments in remote sensing

Tuna and swordfish generally tend to stay within a range of temperatures. Remote sensing data in the form of maps showing sea surface temperature (SST), sea surface colour and sea surface height are useful in deciding where to fish.

**SST:** maps made from data obtained from satellites have proved to be useful in locating fish. The maps show isotherms — lines connecting points with the same temperature. This can be displayed with isotherm lines or with colour.

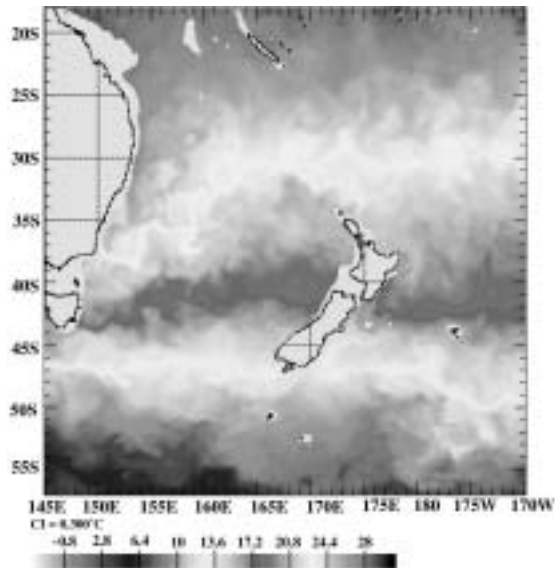

**Sea surface colour:** is an indication of how much microscopic life (plankton) is in the water. Green colour, for example, indicates the presence of an abundance of plankton. Baitfish and larger predator fish (the target species of longline boats) are likely to be found near areas with green colour.

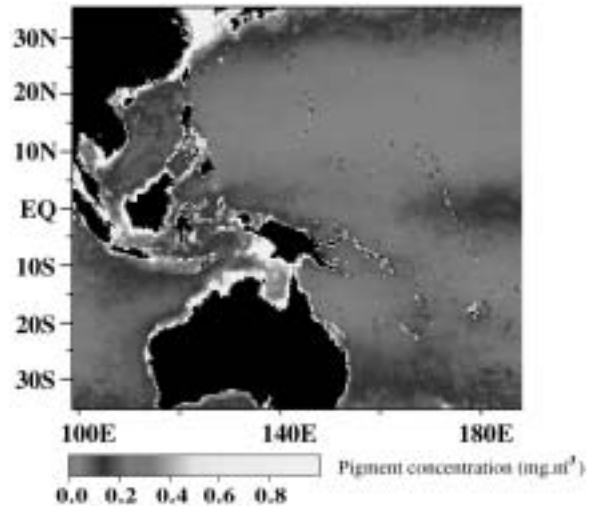

**Sea surface height:** maps reveal the presence of currents, fronts, and eddies. Eddies and fronts (see next section) identified by sea surface height maps may be good places to fish.

The sea surface height is measured by radar from satellites. Sea surface height is expressed relative to the average, or mean, sea level, which is called zero sea level. The sea surface height maps, also called altimetric maps, show sea surface height as contour lines connecting points with the same sea level, in much the same way that weather maps show atmospheric pressure.

Concentric contours with high or low sea levels in the centre indicate the presence of eddies, also called gyres. Closely spaced parallel sea level contours may indicate the presence of a temperature front.

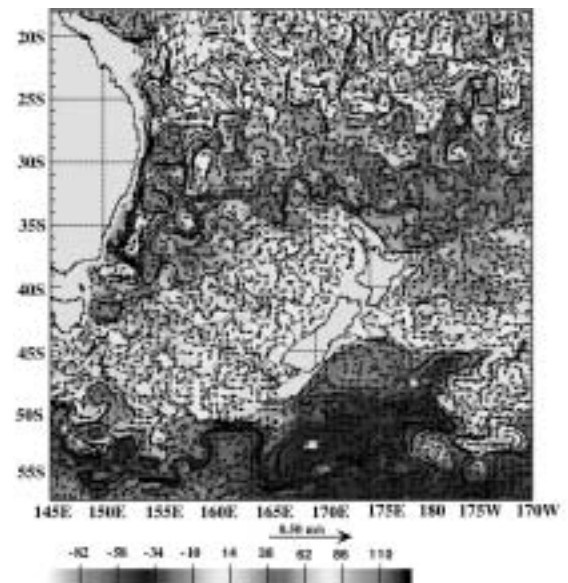

Gyres produced by low-level areas (holes or negative anomalies) are cyclonic while gyres produced by high level areas (peaks or positive anomalies) are anticyclonic. Anticyclonic gyres (peaks) spin counter-clockwise in the Southern Hemisphere and clockwise in the Northern Hemisphere. Cyclonic gyres are just the opposite. Usually the peaks are warmer than the holes.

Because altimetric information is obtained by radar, it is not affected by cloud cover. Unlike SST and sea surface colour, altimetric information is available all the time worldwide.

Some SST, sea surface colour and sea level maps are available on the Internet, while others are available for commercial subscribers.

## C. DECIDING WHERE TO FISH: WHEN ARRIVING AT THE FISHING GROUND

Once the boat has arrived in the general fishing area, the skipper has to make daily decisions on where, exactly, to set his line. He also has to decide whether or not to move each day, depending on the results from the previous set. These decisions are based on a number of factors.

### Temperature fronts

SST is one of the most important environmental parameters that longline fishermen use to determine the location of fish aggregations. Tuna and other species aggregate near sea surface temperature fronts, shown on surface temperature charts as places where isotherms are close together. It may be that the fish are acclimated to a certain temperature range and, thus, seek out water within that range. It may be that forage species — the species the baitfish and tuna feed on — prefer that temperature range. It may be that the temperature front has resulted from a current convergence, and the convergence aggregates the fish. Tuna and broadbill swordfish are usually associated with the warm side of a temperature front.

Charts of SST data from remote sensing satellites are available. Government agencies in many countries provide SST information to fishing vessels and other subscribers. CSIRO in Australia, NIWA in New Zealand, JFIC in Japan, Zonoco in New Caledonia, and NOAA in America all provide remote sensing data. The information can be obtained by fax or on the Internet. Remote sensing charts can be obtained by weather fax two times a week, or in real time using special receivers and software.

SST charts give a general idea of where to find a temperature front. The front must be located by searching and by communicating with other boats in the area. Most longline boats have a SST monitor that has a sensor located on the bottom of the hull and a monitor in the wheelhouse. SST can be read as a number or displayed graphically on an echo sounder monitor.

A front can be seen as a rapid rise or fall in temperature on the SST monitor. Some SST monitors have shear alarms to alert the skipper when a front has been crossed. The change in temperature may range from 0.5° to 2.0°C. In order to determine the orientation of the front (north/south, east/west, north-east/south-west, etc.) the boat would have to cross over the front in several locations. Once a front is found, the SST chart may be helpful in determining its orientation.

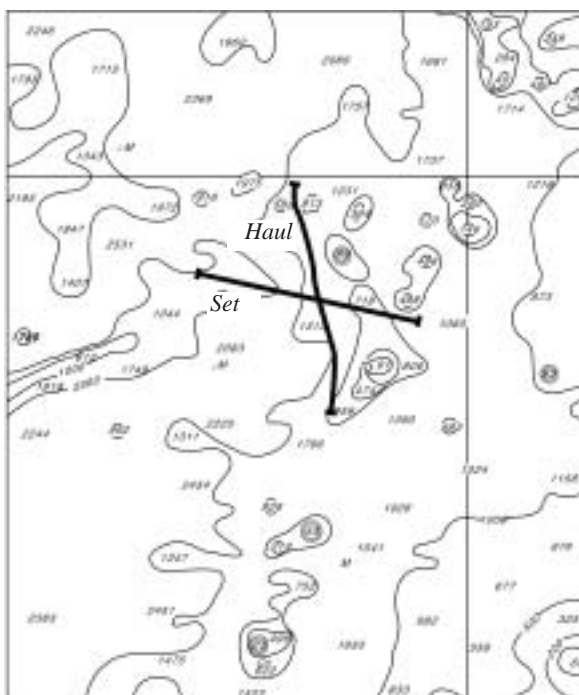
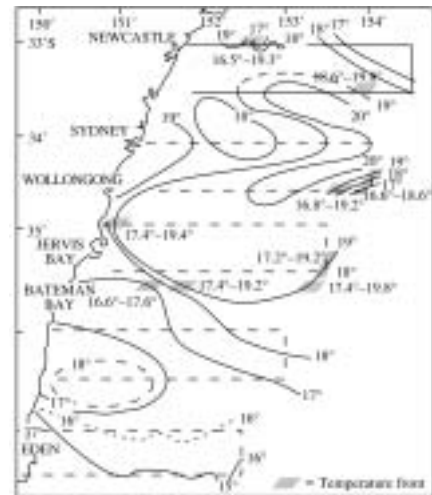

### Current convergences

A current convergence occurs when two currents come together, or converge. Convergences can be identified by changes in current direction over a short distance, changes in the sea surface state along a line, changes in water colour (green on one side, clear on the other), flotsam in the water, scum lines (a line of discoloured, foamy water), or rapid changes in SST.

A convergence causes surface water to sink and mix with deeper water. SST fronts are often the result of current convergences, as the two currents may have different temperatures. A current convergence can often be identified on the plotter after the longline has been set and hauled. For example, if one end of a long east-west set drifted north and the other end drifted south during the soak, this may have been due to a convergence.

Generally, the warmer side of a convergence and the side with clearer water are best. If there is flotsam or a scum line then the set should be made on the side without the flotsam or scum. Tuna are sight feeders. They are not usually found in greenish waters near convergences or upwellings, but on the boundaries where the water is clear.

## Eddies

An eddy, or gyre, is a spiralling movement of water. Small eddies are caused by currents running through channels between islands or reefs, or over seamounts. They are similar to whirlpools but on a much larger scale. Eddies are usually found offshore of points between the windward and lee sides of islands, reefs, or seamounts — in between the side where the current is striking and the sheltered side.

Eddies can cause mixing of water and can be areas where fish aggregate. They can also be the result of upwellings. Water that rises from an upwelling flows away from the upwelling and turns either left (in the Southern Hemisphere) or right (in the Northern Hemisphere). This produces an eddy. Larger eddies are formed near convergences or where water masses come together. A large eddy may be identified on a surface temperature chart as concentric isotherms with the warmer water in the centre. Eddies can also be identified on sea surface altimetric maps as concentric rings.

A longline skipper may be able to identify an eddy on the plotter after he has hauled a set. An eddy will appear when the hauled longline has an 'S' or 'Z' shape on the plotter. It is best to set across an eddy.

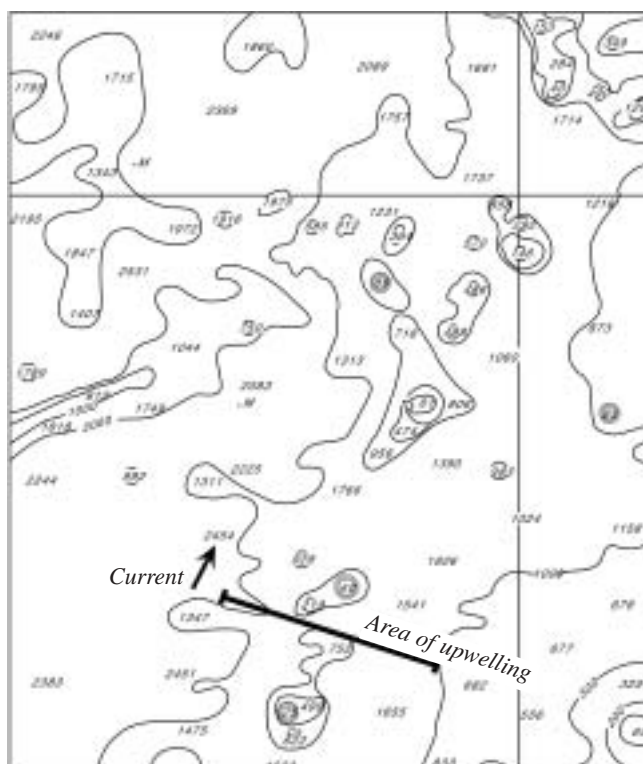
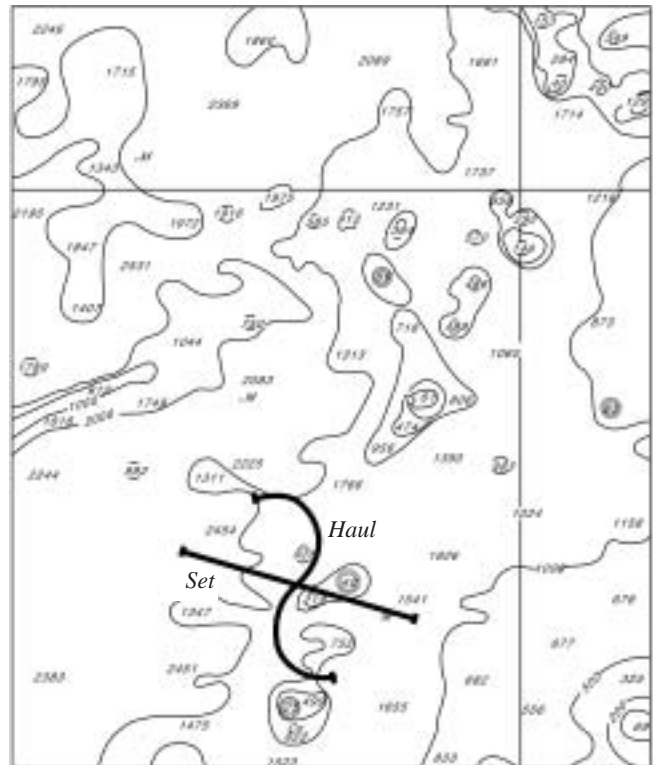

## Upwellings

Upwellings are vertical movements of water caused by wind and currents. A current moving past a shelf or over a seamount will cause bottom water to rise from the depths toward the surface. This deep water is usually cooler than the surface waters and may contain a greater concentration of nutrients than surface waters. Aggregations of baitfish and forage species are often associated with upwellings. Upwellings cannot usually be seen but can be deduced from SST changes or from fish aggregations, and from bottom topography and currents. An upwelling will often occur on the edges of the up-current side of a seamount; that is, the side that the current is striking. As a current carries water toward a seamount the bottom gets shallower. The water has to go somewhere so it rises and moves to either side of the seamount. It is best to set the line so that it drifts into the upwelling.

## D. DECIDING WHERE TO FISH: DURING THE TRIP

All available information is considered when choosing the position and direction of each set. This may include: previous catch results, SST, bottom topography, current direction, bird sightings, fish sightings, bait visible on the echo sounder, water colour, proximity to reefs or land, other boats fishing in the area, weather conditions, and wind and sea direction. If dolphins or whales were sighted during the set or if some of the catch was whale damaged, a new fishing area has to be found.

### The previous set

The outcome of the previous set is probably the most important factor in determining the parameters of the next set. Obviously, if the previous set yielded one of the best catches ever, it may be wise to repeat the set exactly. Usually, however, longline fishermen do not set exactly the same way twice in a row. For example, if there were many dead fish on the line of a tuna set and few live ones, this may mean that there was a morning bite and not an afternoon bite. The next day's set might start earlier to take advantage of this. By contrast, if there were more live fish coming up, then the set and haul might start later the following day, taking advantage of an afternoon bite.

If there were more fish caught on the west end of an east-west set, then it would be a good idea to shift the next set to the west. If the line did not drift much because the current was parallel to the set then the next set should be in a different direction. These are all small moves — sometimes bigger moves have to be made. If there was a poor catch or if whales ate most of the catch, it would be time to make a major move and search for fish. Sometimes a vessel has to run for one or two days to find fish or to get away from whales. Typically, a medium-scale longliner will fish two or three days in an area and then move on. It is rare to get lucky and stay lucky for an entire trip.

### Bottom topography

The seabed has topography much like the land, only on a grander scale. There are mountains, mountain ranges, plains, plateaus, banks, basins, deep trenches, valleys, and canyons on the sea floor. Aggregations of pelagic fish are often associated with bottom topography.

Seamounts, ridges, and isobath curves (a line on a chart connecting places with the same depth — also called bottom contours) are often targeted by longliners. Seamounts are identified on a chart as a cluster of concentric isobaths, with the shallowest ones in the centre. The best way to set near a seamount is to set the line so that the current carries it over the seamount during the soak. This way, advantage can be taken of upwellings and eddies. Often there are aggregations of fish near the summit of a seamount as well. Ridges are similar to seamounts but they are elongated. Seamounts and ridges are good places to target broadbill swordfish.

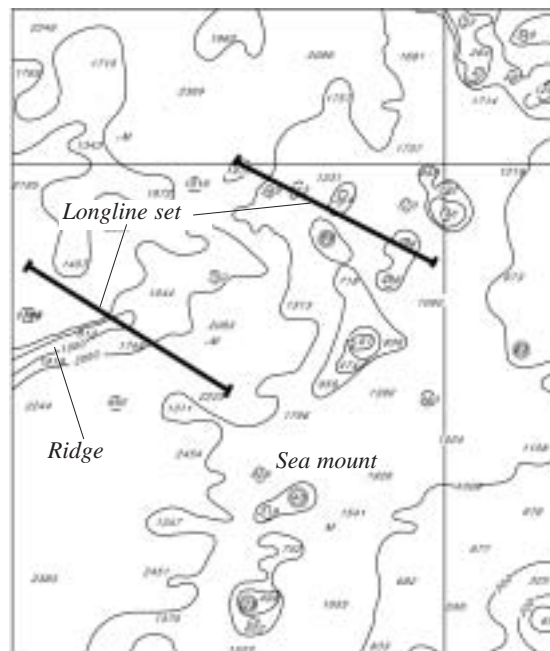

Setting on ridges and seamounts

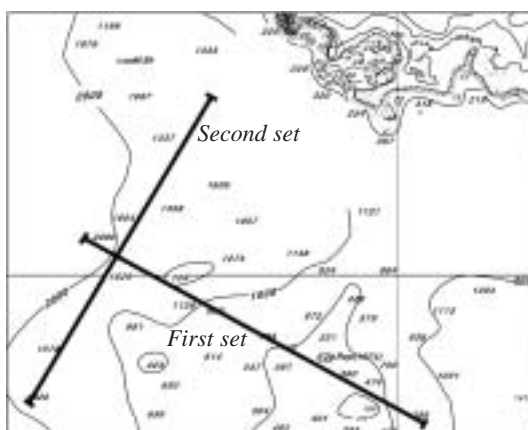

Setting on isobaths

If everything else fails, isobath curves on a chart can be targeted. In certain areas tuna are known to be associated with certain bottom depths. If there are no other parameters to go by, the 1000 m or the 2000 m isobath are often targeted. A good way to find out where the fish are is to set perpendicular to the isobaths on the first set. For example, if a set is made crossing the 1000 m and 2000 m curves and fish are found just inside the 2000 m curve, then the next set might be made following a line just inside the 2000 m curve. If the curves are spaced far apart on the chart, the bottom is flat and fairly uniform. If the curves are close together, the bottom is steep and there may be upwellings or eddies associated with it.



## Seabirds

Seabirds are the fisherman's friends. Birds are constantly looking for small fish, squid, and other organisms to prey on. Larger fish are also looking for the same small fish and squid, but from the depths rather than from above. If there are birds in the area, there are probably fish in the area. If the birds are in a 'bird pile', actively striking the water and feeding on baitfish, then there is probably a school of skipjack tuna or yellowfin tuna beneath the baitfish, feeding from below. If a skipper is searching for a convergence or a front and he finds birds, he has probably also found the convergence or the front. Often there will be larger tunas under the surface feeding tunas, so setting the gear in association with bird activity can yield good results at times.



## Deep scattering layer

Concentrations of planktonic organisms and bait species can sometimes be seen on the echo sounder at depths ranging from 50 to 250 m or more depending on conditions and the time of day. These organisms form a layer that rises at night and sinks back into deeper water during the day. The oceanographers that originally discovered this phenomenon called it the deep scattering layer, because it scatters echo sounder signals.

The deep scattering layer can be picked up on most colour echo sounders. If this layer suddenly becomes more dense on the echo sounder monitor, or if there are red dots or red arches within the layer on the screen, that may mean that there is a high concentration of baitfish in the vicinity, and possibly an aggregation of tuna or swordfish. Red is usually the colour that represents dense material on an echo sounder and arches usually represent fish. If there is an overabundance of forage species and baitfish in an area, the longline bait may not be effective.

## Eavesdropping on other boats

If there are no friendly fishermen in the area, information can still be garnered from other longline operations by eavesdropping. Most skippers and fish masters will not give out position and catch information over public channels — they use Inmarsat-C or coded (secret) frequencies — but if they are broadcasting anything on their SSB radio then a relative bearing to their position can be found using a radio direction finder. If two boats spy on a third using their RDFs, they can triangulate the approximate position of the other boat.

RDFs can also be used to discover positions of radio buoys. While travelling and searching for fish, a skipper can scan the frequency band for radio buoys (1610 to 3000 kHz). This can be done by going up and down in frequency on the tuning dial on the RDF, listening for a beep. Once a beep is picked up, the course is changed to the direction of the radio buoy. After steaming for two or three hours, either the buoy will be found or the other longliner will be spotted on radar. If more than one longliner is spotted there are probably fish in the area.

## E. TARGETING THE GEAR: THE SURFACE LAYER AND THE THERMOCLINE

The surface layer is that portion of the water column where the temperature of the water remains fairly constant, or decreases gradually with depth. It extends from the surface down to the thermocline. The surface layer can be divided into the mixed layer and the intermediate layer. The mixed layer occurs from the surface down to where the temperature is 1°C below the surface temperature. It is mixed by a combination of wind, waves and convection (warm water rises as cooler water sinks). The intermediate layer extends from the bottom of the mixed layer to the top of the thermocline. The temperature drops very gradually with depth in the intermediate layer.

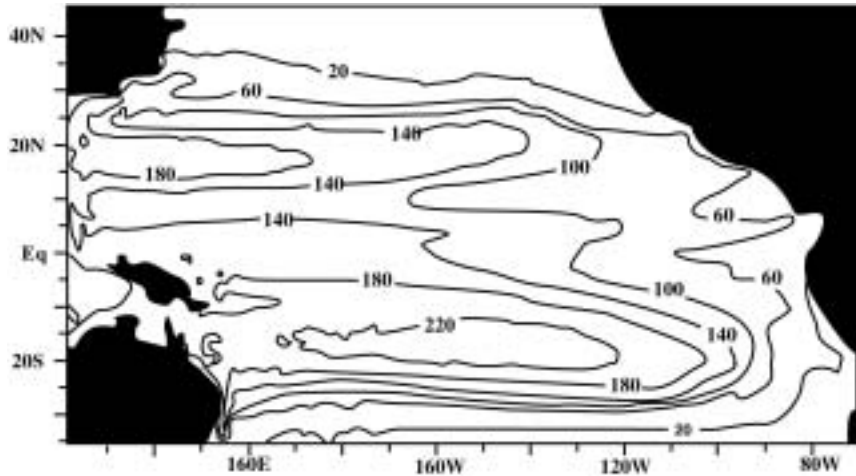

Average depth (m) of the 20°C isotherm (thermocline) in the Pacific Oceans.

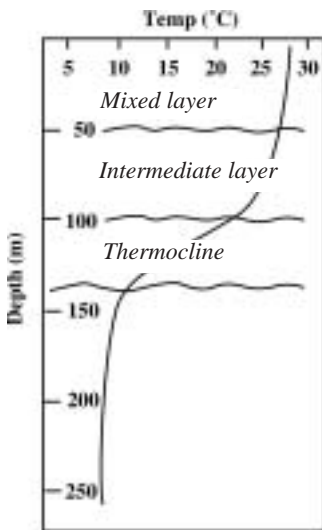

The thermocline is that place in the water column where temperature decreases sharply over a relatively small depth range. In a temperature profile showing temperature against depth, the thermocline shows up as a bend in the graph. The 20°C isotherm is usually used to define the thermocline.

Yellowfin tuna and broadbill swordfish are associated with the surface layer, and particularly with the mixed layer (Chapter 1 C). When these fish are being targeted the longline should be set so that the hooks fish within the mixed layer.

Bigeye tuna and albacore tuna are usually associated with the thermocline. In fact, the optimum temperature range for catching bigeye tuna is 10° to 15°C, just below the thermocline. If a boat is equipped with a bathythermograph, or BTG, a new probe should be taken for each new fishing area. Once the depth of the thermocline is established, the gear can be adjusted to target that depth or just below that depth. Most longliners do not have BTGs. The depth of the thermocline can still be estimated, using information from fisheries scientists and oceanographers. In the tropical central Pacific Ocean the depth of the thermocline generally ranges from 80 to 350 m. It is at its shallowest

at 10°N latitude and it is at its deepest at 20°S latitude. Table 3 gives the average depth of the mixed layer and the 15°C isotherm at various latitudes in the central Pacific Ocean along the 180° meridian. The depth of the thermocline decreases slightly going in an easterly direction and increases slightly going in a westerly direction.

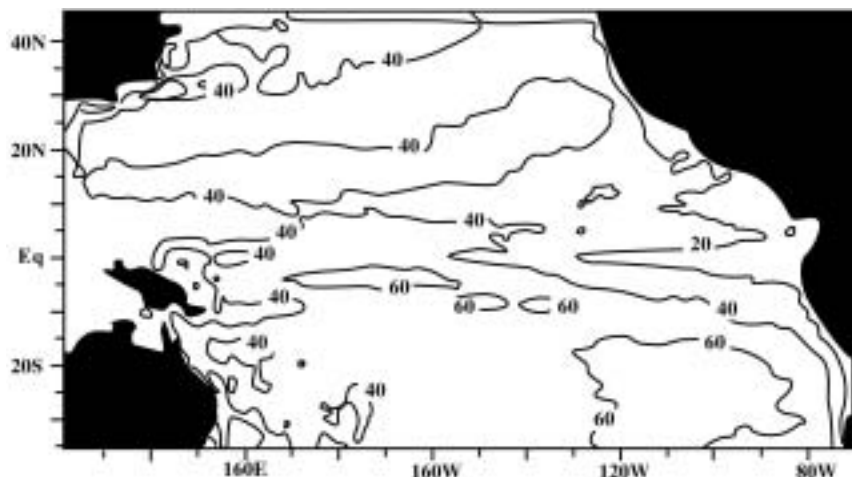

Average depth (m) of the mixed layer in the Pacific Ocean.

**Table 3: Depth of the mixed layer and the 15°C isotherm in the tropical Pacific at different latitudes along the 180° meridian**

Latitude	Mixed layer (1°C below sea surface temperature)	Average depth of the 15°C isotherm
20°N	near the surface	225 m
15°N	80 m	150 m
10°N	25 m	80 m
05°N	100 m	175 m
Equator	100 m	200 m
05°S	125 m	250 m
10°S	100 m	300 m
15°S	80 m	330 m
20°S	near the surface	350 m

### Some tricks for determining temperature and depth

Water temperature at the depth of any hook in a longline set can be determined without the use of expensive equipment. All that is needed is a potato and a thermometer. While setting the gear, a potato is hooked onto one of the branchlines, usually in the middle of the basket. When the branchline with the potato is hauled back later, a thermometer is inserted into the core of the potato. The temperature of the potato core will be very close to the temperature of the water column where the hooks were soaking.

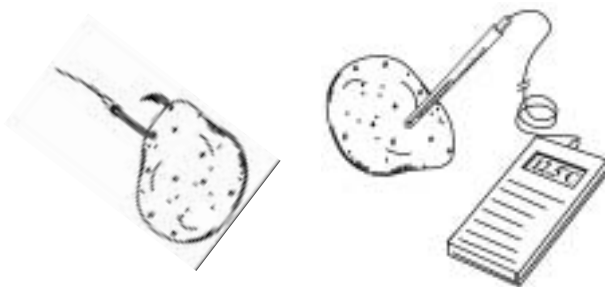

Another way to determine the temperature the gear has reached is to insert a thermometer into an opah as soon as it is gaffed and hauled aboard (tuna are thermoregulators so do not work as well as opah). This should give an indication of the target temperature for bigeye and albacore tuna, as both are often associated with opah.

The depth reached by the deepest hook can be determined using a styrofoam coffee cup. First, several cups must be lowered to different depths on a weighted line. The cups will collapse as a result of the water pressure. The deepest cup will come back the smallest; the shallowest cup will be the biggest. They will stay compressed. Several cups can be kept on board as references, showing different depths at 20, 40 or 50 m intervals. While setting the longline, a new cup is attached to one branchline, usually in the middle of the basket. When the cup is hauled back later it can be compared to one of the reference cups to determine the depth it reached.

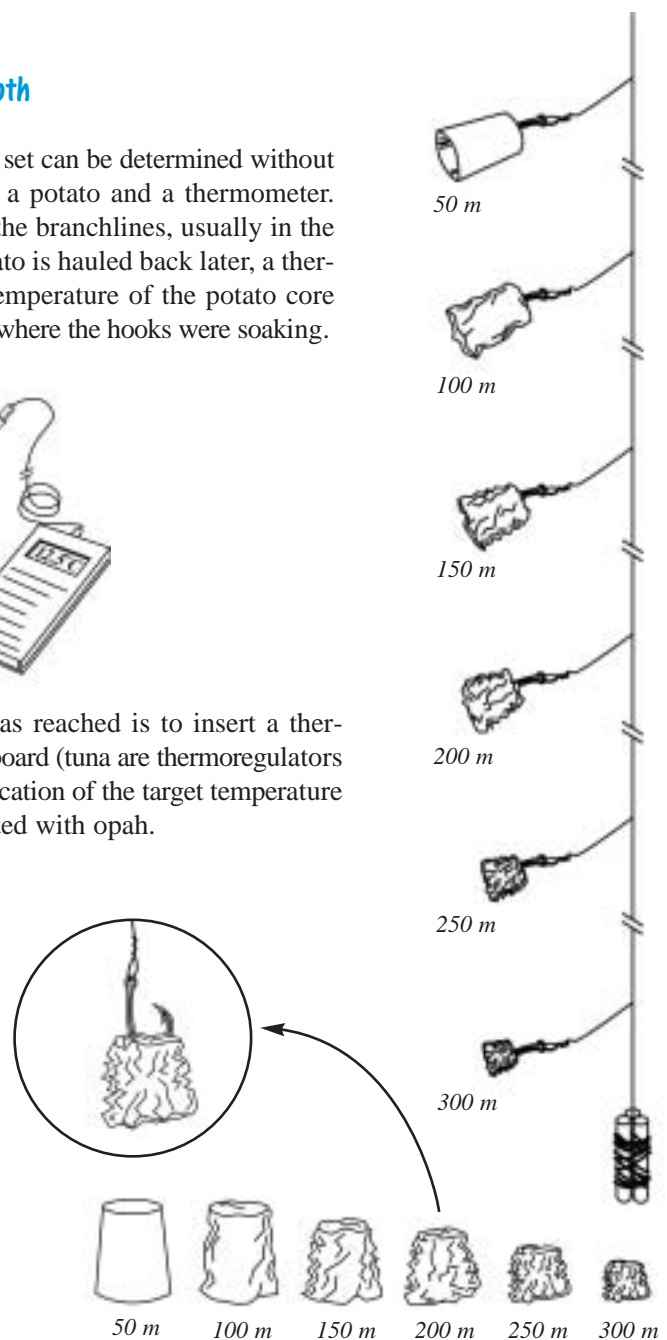

## F. TARGETING THE GEAR: DEPTH OF SET

The depth of the set is important. If a line setter is not used, the length of mainline that goes out is equal to the distance the boat travels during setting. This is called towing the line. A towed line will generally only be as deep as the floatlines. There will be some sag between floats but not nearly as much as when a line setter is used. However, there are ways of achieving a deeper set without the use of a line setter. The gear can be set deeper if longer floatlines are used or if more branchlines are put into each basket. For example, a longline with 30 m floatlines and baskets with 20 branchlines will be deeper than a longline with 30 m floatlines and baskets with 10 branchlines, even though the floatlines are the same length.

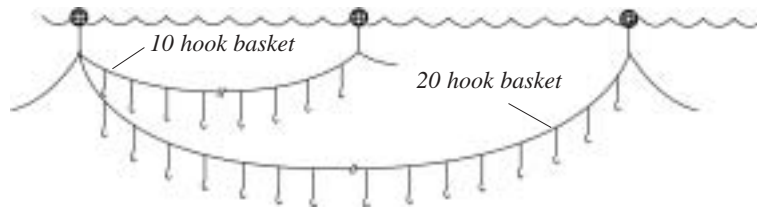

Another way to achieve a deeper set is to attach weights to baskets near the middle branchline. There is a risk, however, that too much weight may cause the line to collapse. When a line collapses, the branchlines sink and the floats come together. In the case of increasing basket size or adding weights, floats should be doubled — two floats to a floatline.

The best way to regulate the depth of the set and to achieve a deep set is to use a line setter (Chapter 2 B). A line setter throws out the mainline at a greater speed than the boat is travelling. That way, there will be a curve or sag in the basket, between the floatlines. The branchlines will not be at a uniform depth but most will be at a depth greater than the length of the floatlines. There are several ways to control the depth of a set when a line setter is used.

### Calculating the depth of the mainline

A horizontal longline sinks in a series of catenary curves, each suspended between two floats (one basket of gear). A catenary curve is the natural curve formed by a line or cable suspended between two points (e.g. telephone lines between telephone poles). On a longline the deepest hooks are found in the middle of the basket. The curve, or sag, of the line is a function of the speed of the boat, the number of branchlines per basket, and the rate at which the line setter deploys the line. The length of the floatlines and the length of the branchlines also determine depth of the line but these dimensions do not change so can be added on after calculating the depth of the catenary curve. However, the true depth will be less than the calculated depth because of currents pushing the floats together, pulling them apart, or pushing up or sideways on the mainline.

To calculate the theoretical depth of the mainline, you need to know the speed of the boat and the speed of the line being ejected by the line setter. The ratio of these two speeds is called the sagging ratio, or SR, and is a dimensionless number (a number without length, weight or time). SR can also be expressed as the ratio of the distance the boat travels to the length of line ejected by the line setter during the same period. For example, if the speed of the boat is 6 knots and the speed of the line being ejected by the line setter is 8 knots, then the SR is  $6 \div 8 = 0.75$ . The same ratio could be derived by comparing the distance that the boat travels between two floats (900 m for our example) to the length of line between the two floats (1200 m) —  $900 \div 1200 = 0.75$ . Once the SR is determined, the depth of the deepest hook on the line can be determined.

To know the speed of the boat, you need only to look at the electronic instruments in the wheelhouse such as the GPS or a speed log. Alternately, the speed can be calculated using chart work and the formula,  $\text{Speed} = \text{Distance} \div \text{Time}$ , or it can be determined by comparing the engine tachometer with known boat speed.

There are several techniques to determine the speed of the line being ejected by the line setter. If a hand held tachometer is available it can be used to determine the speed, in revolutions per minute (RPM), of the large drive wheel of the line setter. The diameter of the wheel is measured and multiplied by 3.14 to obtain the circumference ( $c = \text{dia} \times \pi$ ). A piece of line can also be wrapped around the drive wheel and measured to give the circumference. As the line passes directly over the drive wheel, the amount of line ejected in one minute is equal to the circumference of the drive wheel in metres times the RPM. To find the speed of the line in nautical miles per hour you need to divide this number by 31 (there are 1852 m/nm,  $1852 \div 60 = 31$ , or 31m/min).

Alternately, you can allow the line to be ejected from the line setter for one minute exactly while the boat is not moving. The line is then measured as it is pulled back aboard the boat. Divide this number by 31 to get line speed.

**Example:** during a longline set, the speed of the boat was 4.5 knots and the speed of the drive wheel of the line setter was 250 RPM. The diameter of the drive wheel was 25 cm so the circumference was 78.5 cm ( $25 \times 3.14 = 78.5$ ), or 0.785 m.  $0.785 \text{ m} \times 250 = 196.25 \text{ m}$ . Therefore the line setter ejected 196.25 m of line each minute during this set. Dividing this number by 31 gives a line speed of 6.3 knots ( $196.25 \div 31 = 6.3$ ).

The ratio between the boat speed and the line speed, in this case, was  $4.5 \div 6.3$ , or 0.71, which can be rounded off to 0.7. This is the SR. To obtain the depth of the curve, you can use a table of pre-calculated depths based on numerous SRs and numbers of hooks in a basket. Table 4 gives the theoretical depths for six SRs against five different basket sizes. These depths were calculated on the assumption that the distance between branchlines (and branchlines and floats) is always 50 m. Note: the calculated depths in Table 4 have been reduced by 20 per cent as experience has shown that actual depth is not usually as great as calculated depth.

**Table 4: Theoretical depths of curve of mainline based on different sagging ratios (SR) and basket sizes (based on 50 m between branchlines and between branchlines and floatline)**

Basket size	SR 0.4	SR 0.5	SR 0.6	SR 0.7	SR 0.8	SR 0.9
10	200	190	175	155	130	95
15	290	275	255	230	190	140
20	385	365	335	300	250	185
25	475	450	415	370	310	230
30	570	535	495	445	370	270

Note 1: The calculated depth has been reduced by 20 per cent.

Note 2: Length of floatline and length of branchline need to be added to depth of mainline to give depth of set.

To calculate the theoretical depth directly, you need to know the length of line between two floats and the distance travelled by the boat between floats. Half of the length of the line and half of the distance travelled by the boat each form two sides of a right-angle triangle. The third side is the depth of the curve, and can be calculated using the Pythagorean Theorem — ‘The square of the hypotenuse of a right-angle triangle is equal to the sum of the square of the two sides’ — or  $a^2 + b^2 = c^2$ , where  $a$  is the depth,  $b$  is half the distance the boat travels between buoys, and  $c$  is half the length of line between two buoys.

For example, if the line in one basket is 1050 m long (a basket of 20 branchlines and one float with an interval of 50 m between branchlines,  $21 \times 50 = 1050$ ), then half of the length of line would equal 525 m, or  $c$ . If the boat is travelling at 8 knots during the set (248 m/min:  $8 \times 31 = 248$ ) and the interval between branchlines is 10 seconds, then during each basket the boat travels for 3.5 minutes ( $21 \times 10 = 210$  seconds, divided by 60 = 3.5 minutes) or 868 m ( $248 \times 3.5 = 868$ ). Half of this distance is 434 m, or  $b$ . You can now calculate the depth,  $a$ , with the formula:  $\text{Depth}^2 = 525^2 - 434^2$ , or  $\text{Depth} = \sqrt{(525^2 - 434^2)}$

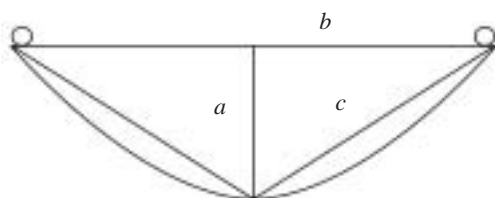

$$525^2 = 275,625; 434^2 = 188,356$$

$$\sqrt{(275,625 - 188,356)} = \sqrt{87,269} = 295 \text{ m}$$

Experience has shown that actual depths will be about 20 per cent less than calculated depths, so the actual depth in this example would be around 236 m.

The depth of the deepest hook can now be calculated by adding the length of a floatline and the length of a branchline to the calculated mainline depth. For example, if the floatlines are 30 m long, the branchlines are 15 m long, and the calculated mainline depth (less 20%) is 236 m, then the depth of the deepest hook is 281 m.



In lieu of the above methods that all require a certain degree of technology or calculation, there is a traditional method for checking that the line is going deep. As the line is being set, the operator grabs onto the mainline as it comes from the line setter just after a branchline has been snapped on. He grips the mainline and counts seconds elapsed until the line becomes too tight to hold. If the boat speed to line setter speed ratio is too close to 1.0 the mainline will come tight in one or two seconds. As the ratio decreases, the number of seconds lapsed will increase. Experience has shown that a time of about eight seconds for the mainline to come tight is about right when targeting tunas (with a boat speed of about eight knots and baskets with 25 branchlines). This time can be increased or decreased for variation in depth of set and requires some experimentation in all cases.



Line setters usually work more efficiently going at their highest speed setting. So for all of the techniques above, it is easier to regulate the speed of the boat rather than the speed of the line setter. Also, the work gets done faster if the line setter is operating at maximum speed, and it would be time consuming to re-calculate the length of line being ejected for different line setter speeds. If you know the length of line when the line setter is going full speed then this calculation does not need to be done again. Boat speed, on the other hand, can be changed easily and a new SR, calculated depth, or hand count of seconds at the line setter can be determined quickly.

### Temperature depth recorders

As noted already, the calculated depth of a set does not usually correspond to the actual depth of a set. Currents and current shears move the line sideways or vertically in the water column. For a fisherman, the actual numbers may not be so important. What is important is what works in a given situation. If bigeye tuna are found when baskets have 25 branchlines each, floatlines are 30 m long, and the boat is going at 6 knots while the line setter is going at an equivalent of 9 knots, then that is the right depth to fish.

To determine the actual depth, temperature–depth recorders (TDRs — Chapter 2 H) would have to be used and they are expensive. At the end of the set when TDRs are recovered from the gear, the data are downloaded onto a PC to give a plot of both the temperature and depth of the gear where the TDR was attached.

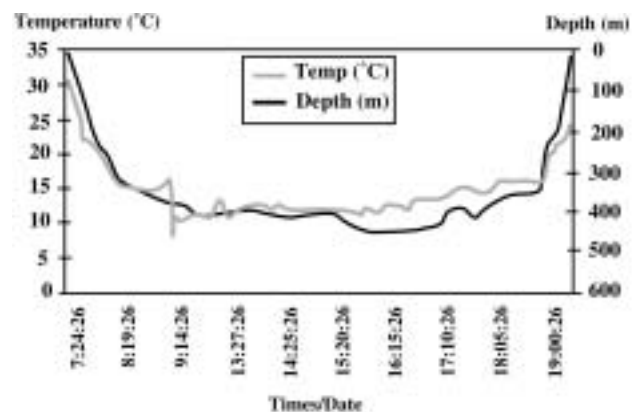
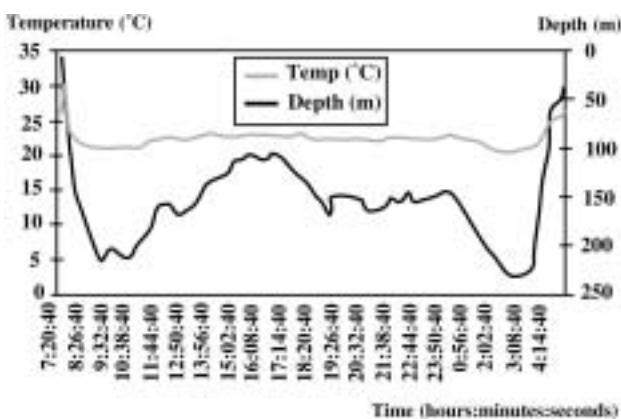

## G. SETTING AND HAULING THE GEAR: GENERAL

In general, when fishing for tuna, the line is set in the morning sometime around first light (0400 to 0800 hours), and hauled starting in the afternoon or early evening (1400 to 1800 hours). If the line is set too early, much of the bait may be eaten by squid or taken by bycatch species that are night feeders. Tunas tend to bite more at dawn and dusk. This may be because bait is more visible during those times or possibly that is when tuna are making their vertical migrations and they are more likely to encounter the bait. When targeting swordfish, which are mainly night feeders, the line is set starting in the evening (1800 to 2000 hours) and hauled starting in the morning (0600 to 0800 hours).

It is easier to set going downhill, or with the wind, and it is easier to haul going uphill, or against the wind. During hauling, the wind should be kept one or two points (one point is  $11.25^\circ$ ) off the starboard bow as the wind acts like a brake to stop the boat when fish are being pulled in. To ensure that the wind will be on the starboard bow during hauling, the wind should be on the port quarter when the line is set.

Usually, the last radio buoy out is the first radio buoy in. This gives the first hooks in the set a much longer soak than the last hooks in the set, but it also gives the crew a chance to rest without having to backtrack to the first buoy. The main reason for hauling the last buoy first, however, is that the line can be set going downhill and hauled going uphill.

Some fishermen backtrack to the first buoy and start hauling with the first buoy of the set. They usually do this to save travel time or to allow all of the hooks in the set to have a more even soak time. Also, it may be a good idea to reverse the line once in a while to spread the wear evenly, as the line closest to the drum gets more compressed than the line on the outside layers.

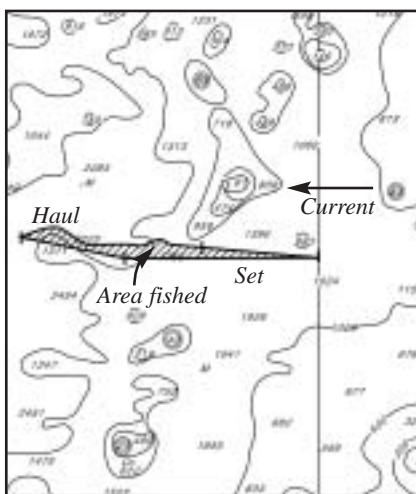
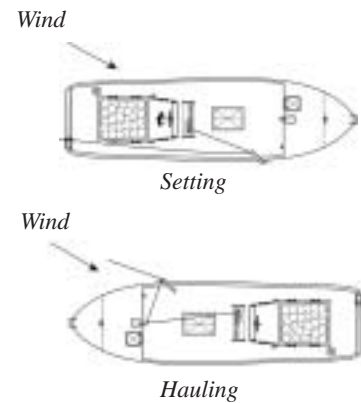

(a) Set made parallel to current

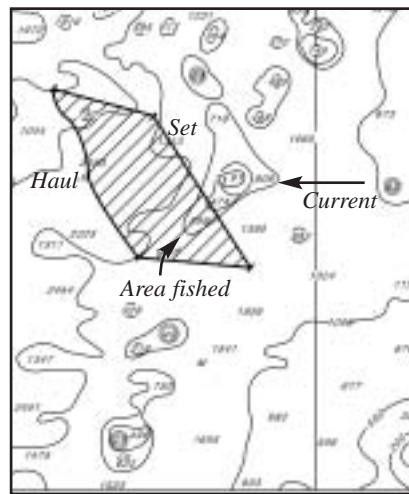

(b) Set made across the current

Ideally, it is better to set the line at an angle to the current. As the line is carried sideways by the current, it will cover a wide area of ocean. If the line is set parallel to the current, it will fish in a narrow band of ocean (a). This cannot always be done when setting downhill and hauling uphill, however. Often the current is running downwind or parallel to the wind. Sometimes a compromise has to be made and the course adjusted accordingly. If the current and wind are parallel then the set can be made so that it is at an angle to both to increase the area fished by the line (b).

It is important to analyse the drift of a line on the plotter after each set has been hauled so that the parameters for the next set can be determined. Currents under the surface often have more influence on the movement of the line than surface currents do, making it difficult to judge the best direction for setting. After the first set is hauled in a new area, movements of the line will be known by looking at the plot of the set compared to the plot of the haul. The next set can then be adjusted so that it fishes the maximum area.

Setting so that the wind is one or two points off the starboard bow during hauling is the ideal situation unless the weather is rough. It is uncomfortable for the crew, especially on a longliner with an aft wheelhouse, to haul going into a strong wind and sea. When the weather is rough it is sometimes better to set so that the wind will be one or two points on the port bow during hauling. To do this, setting is done with the wind on the starboard quarter. This will keep the crew out of the wind and spray. Extra care must be taken, however, not to run over the line during hauling, especially when stopping for fish.

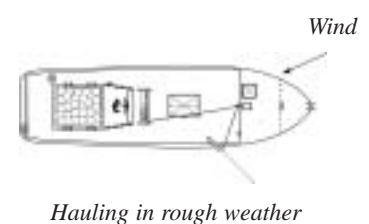

## H. SETTING MONOFILAMENT GEAR

To start a set, the bitter end of the monofilament mainline is routed from the reel to the stern of the vessel, usually through one or more blocks, so that it exits the reel at a 90° angle and is routed around any obstacles. If a line setter is used, the mainline should be entering the line setter at a 90° angle as well. The mainline is passed through the line setter and a loop is formed in the bitter end using a figure of eight knot.

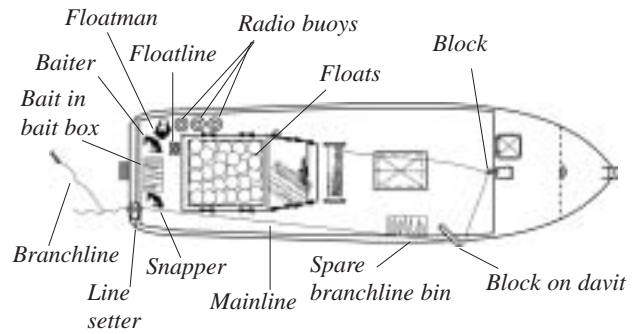

After the boat is underway and the course and speed have been set, the first radio buoy, which is attached to the loop in the bitter end of the mainline, is turned on and thrown over. Usually a float or a float and flagpole is attached as well so that no weight is placed on the radio buoy and it will be easier to find visually. As the boat steams away, line goes out over the stern or out of the line setter. The first basket should be empty — that is, no branchlines attached.

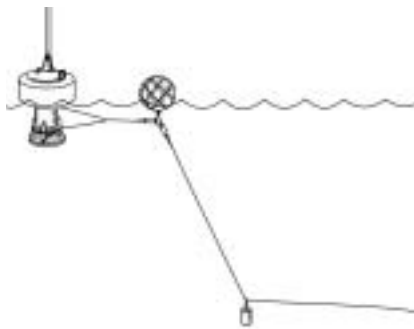

Some longline skippers like to attach weights at each end of the mainline about 30 m or so from the radio buoys. The weights sink the first 30 m of mainline — about the same length as a floatline — so that it does not lie on the surface. Otherwise, another boat passing close to the radio buoy might run over the mainline. This also makes it easier to approach the radio buoy before hauling starts. The beginning portion of line is not always lying in the same direction that it was set and it is almost impossible to see the mainline in the water. Without an end weight, a boat might run over its own line.

Floatlines with floats and baited branchlines are snapped on at appropriate intervals after the first empty basket has gone out. When hauling, the easiest way to remove snaps is to pull them down, away from the moving mainline; therefore, it is best to snap them on upside down. One way to do this is for the snapper, the man snapping branchlines onto the mainline, to turn the mainline around with his hand before he snaps on the branchline or floatline.

The spacing used for tuna sets is usually about 40 to 60 hooks/nm, and 15 to 30 hooks per basket. At 40 hooks/nm of mainline the interval between hooks is about 50 m — or about 7 to 9 seconds on the setting timer (Chapter 3 I), depending on boat and line speed. The branchlines need to be far enough apart so that they cannot tangle with each other, and so that during hauling one can be coiled before the next one comes up. An average setting rate is 400 hooks per hour. At that rate, it would take five hours to set 2000 hooks.

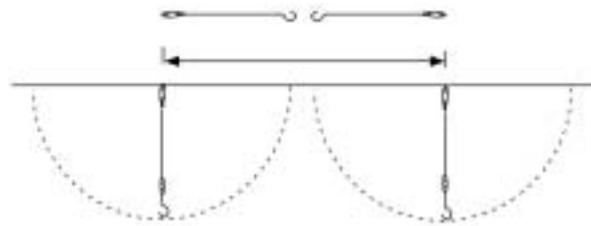

For safety it is important that the snapper coordinate his movements with the person throwing bait, the baiter. He should not snap on a branchline until the baited hook has been thrown, even if the setting timer has sounded a beep. If the branchline is snapped onto the mainline before the baiter throws the baited hook, he may get hooked as the branchline comes tight. The easiest remedy for a fouled branchline is to cut it. It is very dangerous to try to pull the mainline and snap back onto the boat while the boat is moving. If several branchlines get tangled in the branchline bin, it is best to remove them all and give them to someone else to sort out. If too much time is wasted with tangles there will be empty portions on the line and fish may be missed.



Note: a knife or a pair of wire cutters or monofilament cutters should be kept near the line setter at all times while setting, in case a branchline or hook gets fouled.

The setting process continues until all of the hooks are in the water. Another empty basket of mainline (no branchlines) is set at the end. Then, either the end of the line is detached from the reel, or the mainline is cut; a figure of eight knot is tied to form a loop, and the last radio buoy is attached, turned on and deployed. It is helpful to have a flag buoy or a large red inflatable float snapped on near the radio buoy to make it easier to locate.

An autopilot is very useful for setting — the skipper can concentrate on monitoring the vessel electronics and on recording data in the logbook. The skipper can also use this opportunity to talk with the rest of fleet. He can also help on deck if necessary as long as he continues to keep a watch. A longline set with an autopilot will be straighter than a longline set by hand steering.



### Using a line setter with a reel system

There are at least three ways a line setter can be used with a reel. One method links the reel hydraulically to the line setter with a sensor line. The hydraulic motor on the reel acts like a brake and keeps just enough tension on the mainline to allow the line setter to pull line off without it going too fast or causing a backlash. This system has some inherent problems. Adjustments need to be made two or three times during setting as the diameter of the line on the reel decreases, and there is considerable wear on the rubber parts of the line setter — the drive belts and wheels. Another method utilises the reel motor to drive the line off the reel and onto the deck. The line setter merely picks up the slack line and throws it off the stern. In this system there is little pressure on the line setter and expendable parts last longer than usual. In the third method, the reel is allowed to free spool. This is done by opening a crossover valve — usually located on the reel manifold. The line setter pulls line off the reel as fast as the reel can spin. One fault with this system is that if there is a problem and the line setter must be stopped, the reel will free spool unless it is stopped quickly by closing the crossover valve. This could result in a big tangle, with line jumping off the ends of the reel onto the shaft. The line setter is also under more strain than in the second method above.

### Setting gear for swordfish

The gear used for swordfish is basically the same as for tuna, except the hooks are different and the arrangement of the gear is slightly different. The hook spacing is usually about 20 to 30 hooks/nm, and 5 to 10 hooks per basket. At 20 hooks/nm of mainline the interval between hooks is about 100 m — about 14 to 18 seconds on the setting timer, depending on boat speed and sagging ratio. The length of the floatlines is much shorter than for tuna, around 10 to 15 m. Some swordfish boats have additional foam 'bullet' floats to suspend the line between hard floats to eliminate the usual curve in the line.

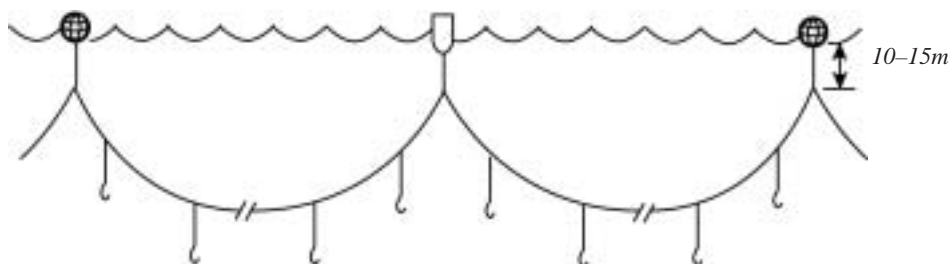

## I. SETTING ROPE GEAR, SETTING TIME, DATA RECORDING AND SOAK TIME

Traditional basket gear is set differently than monofilament gear, while setting automated rope gear is very similar to setting monofilament gear. Also, a major part of the setting process for all gear where the branchlines are snapped onto the mainline is to get the correct spacing between branchlines and floatlines along the mainline, and to record the setting data for comparison at the end of the haul and for future reference.

### Traditional basket gear

Traditional basket gear is usually set manually, as the branchlines are permanently attached to the mainline. Because of this, the mainline is thrown in coils to ensure the line is slack at all times. The three main men during setting are the baiter, the line thrower, and the float man. The baiter baits the hooks and throws the baited branchlines at regular intervals. The line thrower throws the coils of mainline off the stern from a setting table at a regular pace. The float man throws floats and floatlines. The other men pass coils of mainline back to the thrower, carry baskets of gear to the stern and tie them together, pass floats and bait, etc.

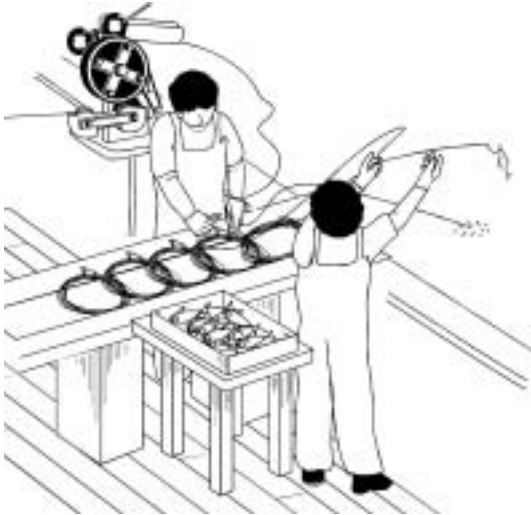
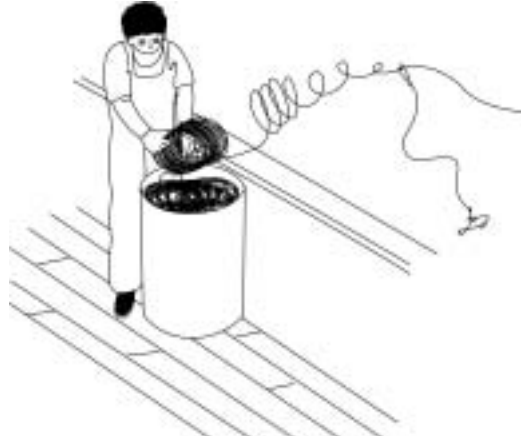

### Automated rope gear

Automated rope gear is set in the same manner as monofilament gear. The rope is fed to the stern of the vessel via blocks, with a line setter usually used. The branchlines are individually coiled and transported to the stern on a conveyor. One person unties the slip knot to release the branchline and passes the snap to the snapper, then attaches the bait and throws the baited hook and branchline. The snapper then attaches the snap to the mainline. Another person attaches the floats and floatlines at regular intervals.

### Setting timer

Most longliners use a setting timer. A setting timer gives off an audible beep at set intervals, ranging from 6 to 20 seconds. At the sound of the beep the baiter throws a baited hook and then gets the next hook ready. Usually the baiter counts hooks in each basket and calls for a float at the right interval. Basket size can be adjusted on some setting timers, however. The number of hooks in a basket can be set on the setting timer and a different beep sounds for floats. Even more sophisticated setting timers, for example the Hookmaster timer from Japan, allows the operator to set the space interval between every two beeps either in time intervals or in length of mainline. With this type of setting timer the exact length of mainline let out is known, so depth of the set can be better controlled. The Hookmaster works in conjunction with a line monitor built into the line setter.



Often, a longer length of line is allowed between floats and the first and last branchlines in a basket. There are two reasons for doing this: one is to avoid catching shallow water bycatch species; the other is to avoid tangles between floatlines and branchlines. When a simple hook timer is used, the spaces between branchlines and the floatline can be timed by counting two beeps before and after a float is thrown. With a Hookmaster, the time or length interval before and after a float can be increased.

## Recording data

As soon as the last radio buoy is thrown, everything about the set should be recorded including: start and stop times, number of baskets, number of hooks, positions of both ends of the set, radio buoy frequencies, wind and current direction, sea conditions, and moon phase. It is important to write everything down even if some of this information is recorded on a plotter. A plot of the set can also be drawn, with pencil, on the chart or on plotting paper. If the set was made within radar range of land features, then a radar fix should be plotted for each end of the line.

It is also a good idea to watch the drift of the boat for twenty or thirty minutes after it is shut down at the completion of setting, and to record the compass direction back to the end buoy. If the boat drifts away from the last buoy on a course of 270°T, for example, a reciprocal course of 090°T would get back to the approximate position of the line. If the electronics fail later, the line can still be found by using this information. It is a good idea to steam back to the end buoy at least once during the soak. The new position of the end buoy should be recorded, along with the set and drift of the current.

**Example:** Set #3 started at 0530 hours at 21°10.450'S and 175°50.000'W going 280°T. Set finished at 0930 hours at 21°06.500'S and 176°33.100'W, with 32 nm of line and 1600 hooks in 20 hook baskets. Bait is saury. #1 radio buoy is 1732 kHz and #2 radio buoy is 1768 kHz. Wind is moderate from SSE. Seas are slight. Current is NNE at 0.5 knots. Boat is drifting at 250°T at 0.5 knots. Course back to gear is 070°T.

After 2 hours of soaking the #2 radio buoy drifted to 21°06.000'S and 176°3.100'W. Current set at 000° with a drift of 0.25 knots.

In the above example the line did not move in the same direction as the boat. It also did not move in the same direction as the apparent current. The boat was affected more by the wind while the line was affected by the wind and the current and by currents below the surface. It is difficult to predict where the line will be after soaking for several hours. That is why it is best to record everything and then check the line halfway through the soak.

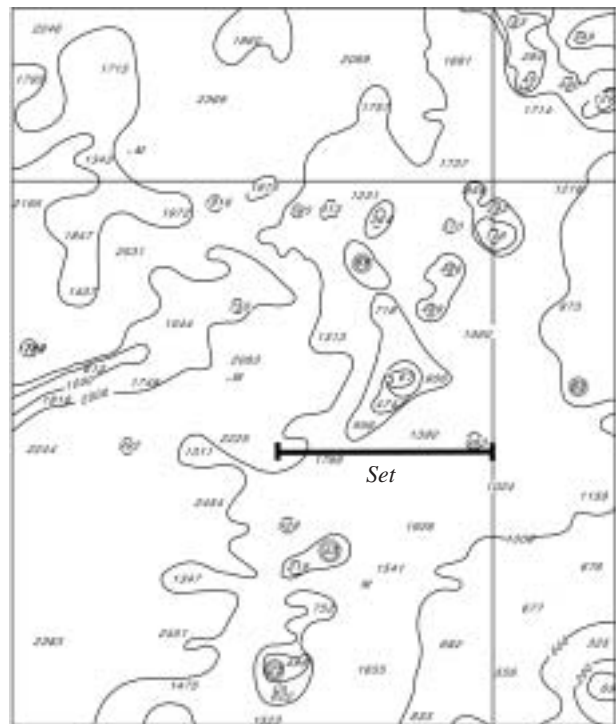

## Soak time

Soak time is usually measured from the time the last buoy of the set is thrown until the first buoy — usually the same buoy — is hauled. In a normal set the first baskets thrown will have a much longer soak time than the last baskets thrown, as they are the last to be hauled. The soak time recorded on fishing logs is, therefore, usually the minimum soak time and not an average. This time can vary from about 3 hours to as much as 8 or 9 hours, depending on length of mainline, fishing conditions, fishing strategy, weather, etc. A typical tuna set might have started at 0800 hours and finished at 1200 hours, for example. If hauling started at 1600 hours, then the last hooks thrown would only have had a 4 hour soak. If hauling finished at 2400 hours, then the last hooks hauled would have had a 16 hour soak. The recorded soak time for this set would be 4 hours.

With a more even soak time, such as in a backward set (Chapter 3 J) every hook would have about the same chance of catching a fish, all other factors being equal. Also, there may be fewer dead fish on the line. Yellowfin and bigeye tuna can stay alive for 2 to 3 hours after being hooked, but most fish would be dead after several hours on the line. If the first hooks in a normal set catch fish soon after being deployed, then those fish will likely be dead when hauled and will not be as valuable as other fish that came up alive. Fish left on the line for several hours are also more prone to predation by sharks and whales.

## J. SOME VARIATIONS ON SETTING

There are many variations on the way the gear can be set. This is true for both monofilament and basket gear.

### The backward set

Longlines are not always set going downhill in a straight line and hauled going uphill. Sometimes the line is set and hauled going in the same direction. In other words, after the line is set the boat returns to the first end of the line and hauling starts with the first buoy thrown over. One of the reasons to haul this way is to save time. A longline skipper trying to keep to a tight schedule, for example, might want to save time on the last set of a trip by setting and hauling in a direction that would get him closer to port. If a line is set and hauled backwards, the line is usually set upside down, that is, the snaps are put on the mainline the opposite way they usually are snapped on and the sequence of floats is reversed. If light buoys are usually thrown out first as in a normal day set, they are thrown out last in a backward set. In either case, the light buoys will be on the last part of the line to be retrieved. The disadvantages of a backward set are that the line will be set and hauled with the same orientation to the wind, and that the crew will not have much rest during the soak. One advantage of setting and hauling in the same direction, however, is that all hooks in the set will have a more even soak time.

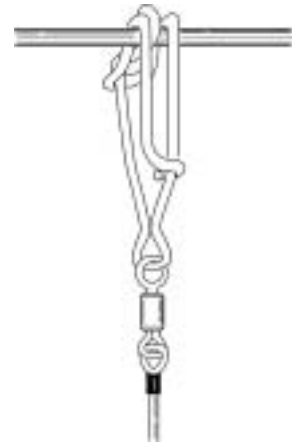

### The hook set

Another variation in setting is to put a hook shape in the first end of the line. Often when a line is set across the current it will be parallel to the wind; or the current may shift after setting so that it is parallel to the set. If the current or wind are strong enough to push the first float and first few baskets of line back on itself, the end of the line may collapse, resulting in a bad tangle. This tangle will be on the last portion of line hauled at the end of the night so this situation can be quite frustrating.

A good way to avoid the first end of the line collapsing is to put a hook into the set — that is, to set the line in an ‘L’ shape. For example, if the intended course for the set is  $290^{\circ}\text{T}$ , then the starting course would be  $000^{\circ}\text{T}$ . After one or two nautical miles of line has been set, the course is changed to  $290^{\circ}\text{T}$ . During the soak, if the wind or current pushes the end of the line in a westerly direction, it will not collapse back on itself but will pass itself a mile or two to the south, forming a loop. At the end of the haul, a loop in the line is easy to pull. The hook is usually put in the line such that at the end of the haul the boat will turn to starboard.

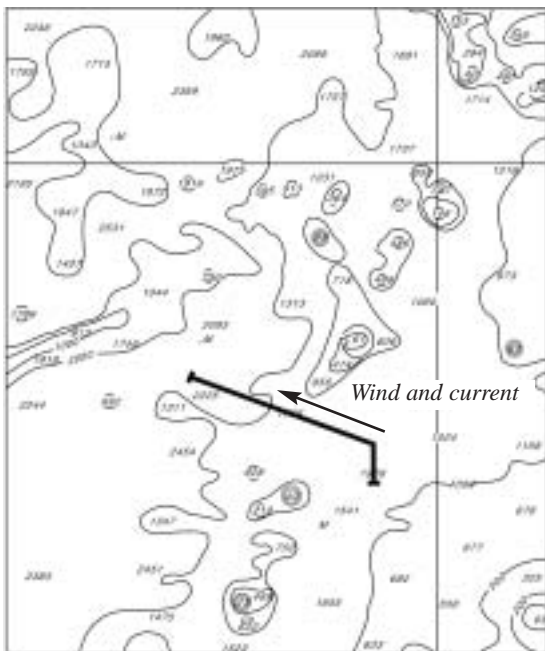

### Stretching the end of the set

An alternate method to putting a hook in the end of the line is to tow, or stretch, the end of the set. If the current and wind are parallel to the direction of the set, problems can be overcome by towing the first or last few baskets. If, for example, the direction of the set is  $290^{\circ}\text{T}$  and the current is running in the same direction, then the first five baskets could be set with an SR of 1, by using the line setter as a fairlead only and not engaging the hydraulic drive. The line is towed, or stretched, so that it has no sag. After five baskets of line has been set the line setter is engaged so that the rest of the line is set with an SR of 0.75, for example. If the current was running opposite to the direction of the set then the last end of the line would be stretched rather than the first.

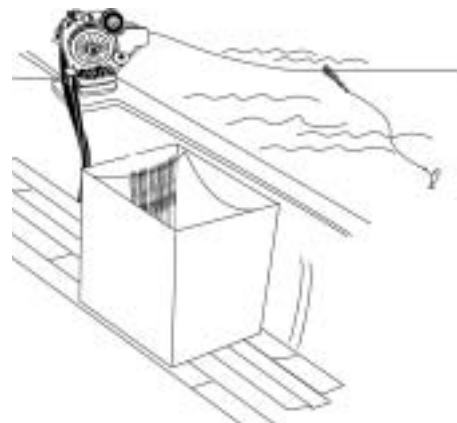

Later, as the current tended to push the end of the line back on itself, a sag would develop but not enough of a sag to collapse the line. Obviously, it would require some experimentation to get this just right.

### The horseshoe set

Every time a target fish is landed during hauling, it should be recorded and a position entry should be made on the plotter by pressing the mark or event button. After hauling the line and looking at the catch results on the plotter, it may be found that fish are concentrated in one area. A straight set the following day may miss most of the fish in this case. To avoid this, the line can be set in a 'U' shaped loop, or horseshoe shape, to get more hooks in the area where the fish are concentrated. Care must be taken with a horseshoe set that the line does not collapse on itself. The two ends of the horseshoe should be several nautical miles apart and should be parallel to the wind and current. The middle part of the horseshoe should be perpendicular to the wind and current if possible. The main disadvantage of a horseshoe set is that part of the haul has to be done going downhill, part of the haul has to be done going uphill, and part of the haul has to be done in the trough.

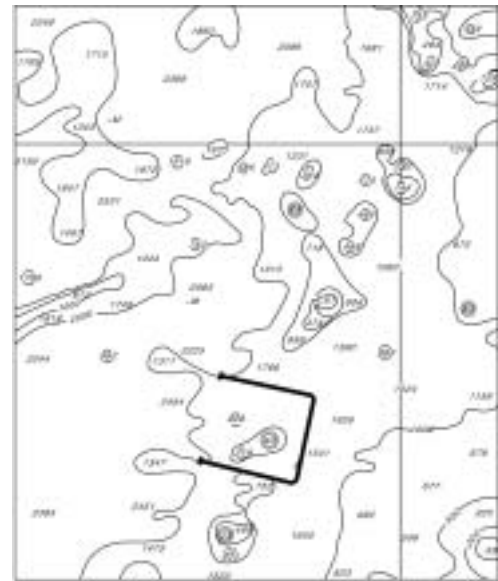

### Following a front

Another variation in setting is to follow a temperature front. It may be found that a temperature front runs for several nautical miles over a zigzag path. When setting on a temperature front, it is usually best to set on the warm side. The temperature sensor has to be constantly monitored and the course changed as the temperature goes up and down. If the warmer water is to port, for example, and the water starts to get colder, the boat should be steered slightly to port until the temperature reading goes up again. If the water temperature goes up, then the boat is steered to starboard until the temperature starts to drop again. A set done on a temperature front will not usually be in a straight line. In some circumstances it is better to cross over the front several times. That way, when the line is hauled, it can be determined if fish are on the warm side or the cold side of the front. If the current is running perpendicular to the temperature front then the line should be set on the up-current side so that it will drift across the front.

### Courtesy to others

When setting longline gear in the vicinity of other longline boats, problems and conflicts can be avoided. If a set is made parallel to another boat's gear then a distance of several nautical miles should be kept between the two lines. It is also helpful to contact the other boat to let the skipper know your intentions and to find out what his course will be for the entire set. If a crossing situation cannot be avoided because the two boats are on different courses, then it is best to cross the lines at a 90° angle. It is also helpful if the crossing boat does not snap on any branchlines for 100 or 200 m on either side of the other boat's line. This will help to avoid tangles when the lines are hauled. During hauling, if another longline is found to have crossed over the mainline, the crossing line must be cut. As a courtesy to the other fishermen, the two ends of the cut mainline should be re-joined.

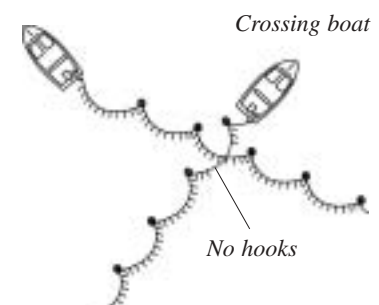

## K. FINDING THE GEAR

Before hauling starts, the line has to be found, usually by steaming towards the radio buoy signal. If the RDF or the radio buoy is not working then a search must be conducted. The course back to the end of the line can be found on the plotter or from the skipper's notes in the logbook. The direction would be the reciprocal of the drift away from the line after the last buoy was thrown. When searching for a buoy or flag, all hands should be on watch.

If the radio buoy is giving a good signal, it is best to set the course slightly away from the direction of the signal. The RDF gives some indication of distance by showing the signal strength. However, this can vary with the strength of the battery pack in the radio buoy so should not be relied upon. If the boat steams directly toward the radio buoy, there is a danger that it will not be seen and the boat will run over it. That is why the course should be about 5° off to one side. As the boat gets closer to the radio buoy the relative angle of the signal from the radio buoy will increase. If the course is changed periodically during the search so that the bearing is always about 5° relative, then the radio buoy cannot be missed. Eventually the angle will increase rapidly until the buoy is bearing at 90°, or abeam of the boat. By then it should be in sight.

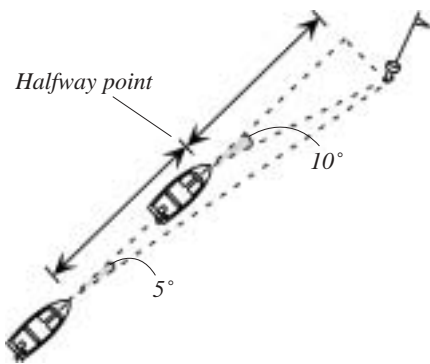

The radio buoy should be approached from the downwind side with the wind slightly to the starboard side of the boat. As the boat stops to recover the buoy, the wind will hold the boat off the buoy and line. The boat should be turned to port just as the buoy is recovered. If the buoy is approached from the upwind side, there is a danger that the boat will blow over the radio buoy and line, causing the line to foul on the bottom or in the rudder or propeller, and possibly causing damage to the radio buoy.

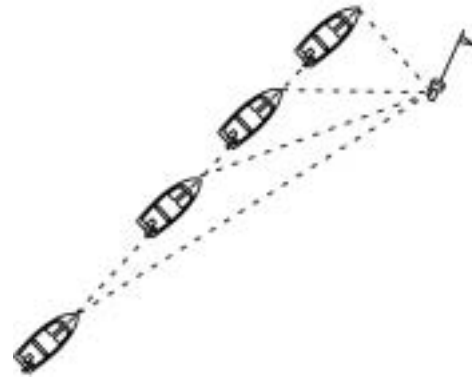

The distance to the radio buoy can be estimated by using the rule of doubling the angle on the bow: when the angle has doubled, the distance is half of what it was when the search started. For example, if it takes 15 minutes for the radio buoy signal to go from 5° to 10° relative, then the radio buoy is 15 more minutes away, as long as boat speed stays the same. If the boat speed is 10 knots, then the distance to go would be: Distance = Speed x Time = 10 nm/h x 0.25 h = 2.5 nm.

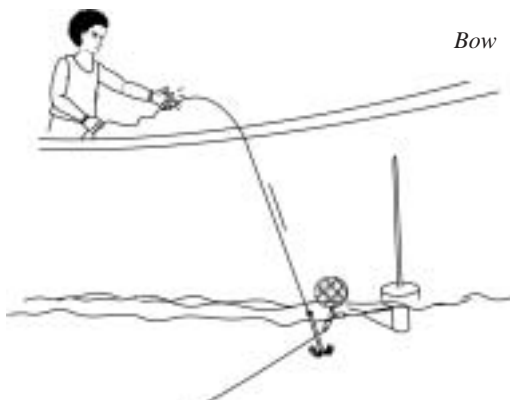
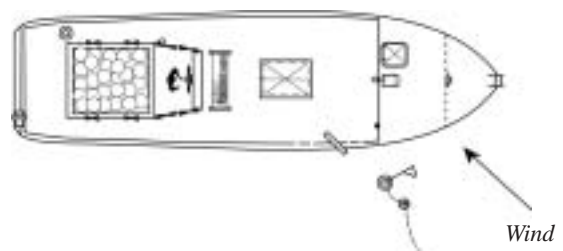

Some vessels use a small grappling hook on a throwing or heaving line to retrieve the radio buoy. When the boat is positioned close to the radio buoy, the grappling hook is thrown over the mainline and allowed to sink over the line. The hook is then slowly pulled in with the mainline hooked on. The radio buoy can then be retrieved.

## L. HAULING BASKET GEAR

After the radio buoy is recovered, it is detached from the mainline and moved to its storage position, secured and turned off. If there was a flag buoy close to the end of the mainline, this is also removed and stored. The end of the mainline is then passed through the line hauler, ready for the hauling operation to commence. The mainline is usually guided onto the hauler through a fairlead roller mounted on the rail. The main men on deck are the coilers, the basket maker, and the basket staker.

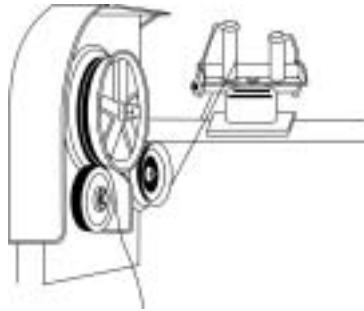

The coilers operate the control valve for the line hauler. As the mainline comes through the roller, each branchline is grabbed by a coiler and guided through the hauler so that the snap lands on the coils of mainline. The hauler keeps going while this is done. The coils of mainline pile up under the hauler, usually on a basket table. A coiler then coils the branchline rapidly and places it on the coils of mainline before the basket maker piles more coils of mainline onto the pile.



The basket maker's job is to guide the line coiling up under the hauler so that the coils are uniform. As each section finishes coiling, he places it on the accumulating pile of coils. This is repeated until a full bundle or basket is made. The basket is then detached from the rest of the mainline by the basket staker — the joins are made with sheet bends — and tied together with a cord and stacked in a cage or bin. Sometimes there are two bundles per basket so there is a join in the middle. The basket staker also replaces tangled or damaged branchlines and makes repairs throughout the haul.



The coilers use the line hauler to pull in floats and floatlines. Other crewmen gaff and handle the catch. The crew usually rotates after every ten baskets or so.

With automated rope gear, the branchlines and floatlines are unsnapped from the mainline, and coiled using a branchline coiler. The mainline is carried from the line hauler to a guide pipe by a small conveyor belt and then is pulled aft by the line arranger. The line arranger arranges the line into bins, which are aft of the wheelhouse. A large conveyor belt carries floats and bundles of floatlines and branchlines aft for storage.

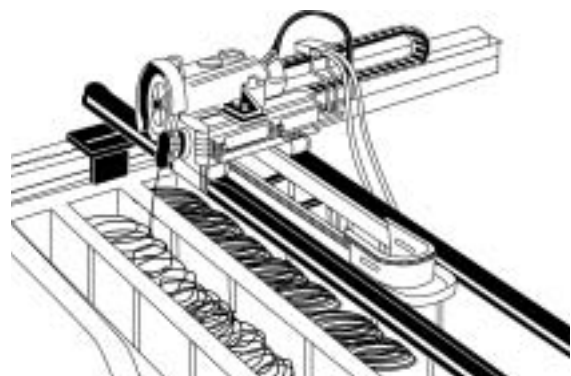

## M. HAULING MONOFILAMENT GEAR

After the radio buoy is recovered, the mainline is secured to a cleat or the rail. The radio buoy is then detached from the mainline and moved to its storage position, secured and turned off. If there was a flag buoy close to the end of the mainline, this is also removed and stored. The end of the mainline is secured to the reel. The line is then detached from the cleat and guided to the reel by a longline block hanging from a davit. This is usually an open block made of aluminium with a stainless steel sheave and roller bearings. The block is usually hung at about head level so that the operator can position one hand on the mainline in front of the block.

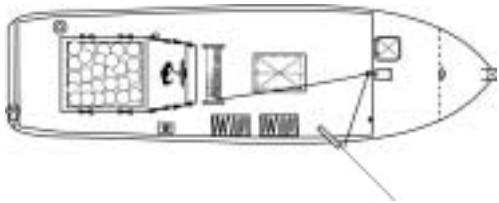

Once the line is secured to the reel, hauling commences. Most reels have a level-wind mechanism to evenly spread the mainline over the drum of the reel. The speed of the boat and the speed of hauling the line have to be matched. This takes a good deal of coordination between the operator and the person controlling the reel. The best layout for hauling is to have an outside steering station, with all the controls for steering the boat and hauling the gear in one place. This allows the hauling operation to be conducted by one person.

The main man on the deck during hauling is the rollerman. He operates the control valve for the reel, and sometimes operates the boat as well. His job is to control the speed at which the line is recovered and to unsnap branchlines and floatlines as they come up. As each snap strikes the rollerman's hand, it is unsnapped, and pulled down, away from the mainline.

The rollerman should keep his right hand on the mainline while hauling. His left hand should be on the control valve so he can stop the line quickly. With his hand on the mainline he will be able to sense if there is a fish coming up. He can inform the operator — if the rollerman himself is not driving the boat — and the vessel can be slowed so the fish can be played or brought up slowly. He can also feel any bad spots in the line. The reel does not have to be stopped when branchlines come up, unless there is a fish or a tangle. The snaps will slide on the mainline if they are struck with a gloved hand. They can be unsnapped while the mainline is still moving.

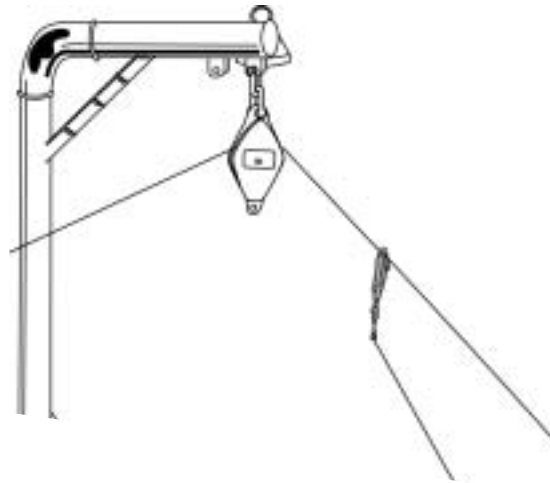

Longline blocks can also be used as line guides to change the angle of the line going from the first block to the reel. Often, two or three blocks are used in hauling to direct the line around areas where people are working and onto the reel squarely. If longline blocks are used as line guides they are often reversed so that they function as closed blocks.

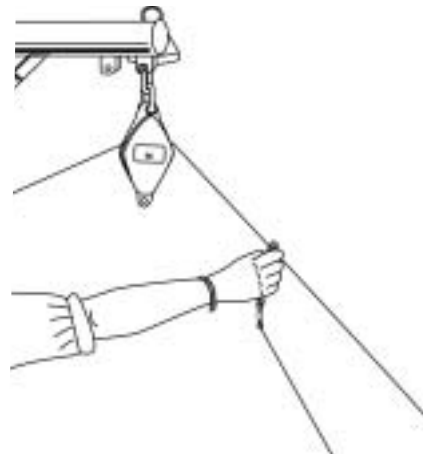
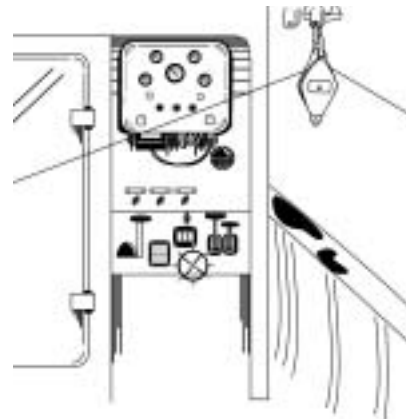



When a knot comes up on the mainline, the reel must be stopped unless the snap can be removed before the knot hits it, as a snap will not slide past a knot. If a knot were allowed to hit the snap and the rollerman's hand was on the mainline, he could get injured as his hand collided with the longline block. Also, the mainline may part. The open block is used in case there is a tangle or a knot on the mainline and the branchline is not unsnapped — the snap will pass through an open block easily.

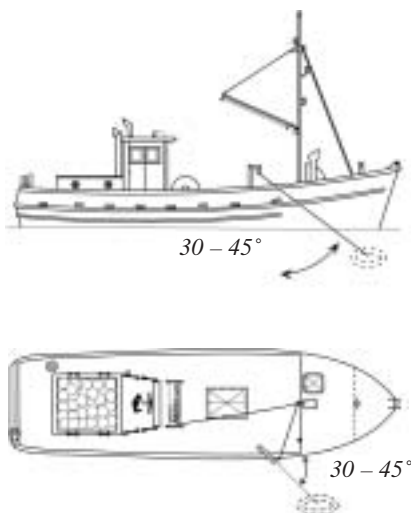
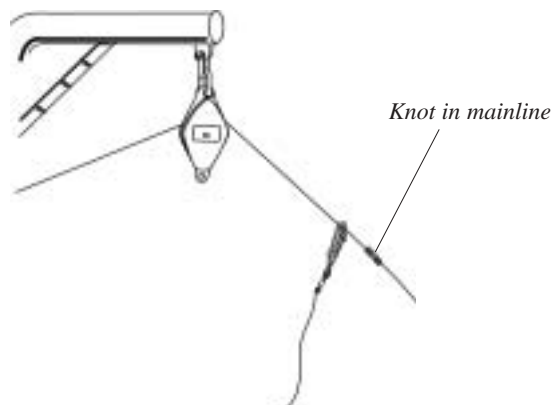

It is important that the line coming up be visible to the rollerman and to the boat operator. The best position for the line is just to the side of the boat and just in front of the longline block. During hauling, the boat is kept slightly away from the track of the line so the line stays at about a 30° to 45° angle in front of and to the side of the boat. Hauling from this position will keep branchlines and floatlines clear of the mainline. If the boat runs over the mainline there is a danger that an unseen fouled branchline will come up and injure the rollerman, or a fish may be lost. The boat may also run over floats and floatlines. If the line is too far out to the starboard side of the boat there is a danger that the line will have too much tension on it and will part. Too much tension on the mainline will also cause branchlines to spin and wrap around the mainline. If the line is allowed to run at an angle behind the block then it may get fouled in the rudder or propeller, or branchlines or floatlines may get caught in the propeller or get fouled on the mainline.

The coilers stand directly behind the rollerman. Their job is to take the snaps from the rollerman and coil the branchlines into the branchline bins, haul in the floats and coil the floatlines, and gaff and handle the fish.

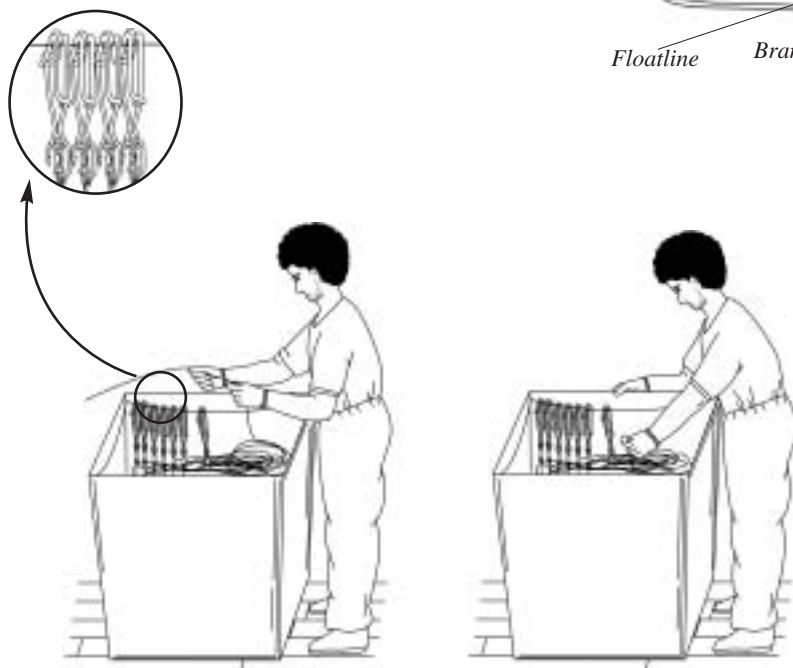
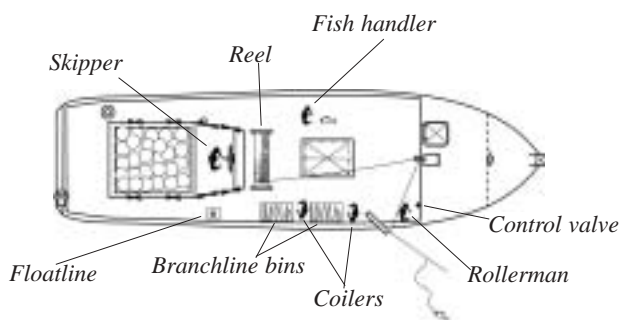

The coiler attaches the snap to the bar or line in the branchline bin, and pulls the branchline in with a hand over hand action. When the hook is reached, any bait is removed and the hook placed through the snap for that branchline. The next snap is attached beside the last, so a sequence or order is formed. This continues until the branchline bin is full or all the gear is hauled. There is usually more than one coiler, and each is coiling branchlines into a separate bin.

## N. ENCOUNTERING PROBLEMS WHEN HAULING THE GEAR

A good hauling rate for monofilament gear is 200 hooks per hour. It would take 10 hours to haul 2000 hooks at that rate. However, the rate is usually slower because the line has to be stopped for fish and when problems are encountered. It may take 15 or 20 hours to haul 2000 hooks. Branchlines can get tangled with the mainline. The mainline can get fouled on the bottom of the boat, it can get tangled, and it can part. Sea and weather conditions can change. Sharks often run the line under the boat, fouling it on exposed zinc anodes or on keel cooler pipes. The line can also get caught in the rudder or propeller. There are several things that can be done to prevent or remedy these situations.

### Branchline tangles

Branchline tangles can be minimised by keeping the boat on course and on track, and by hauling the line at a steady pace. Weather and sea conditions, however, can cause branchlines to spin around the mainline. This also can happen when a large fish runs with the line. The reel has to be stopped each time there is a branchline wrapped around the mainline. This can add several hours to hauling time and can be very frustrating. There are several ways to undo tangles quickly. One method is to spin the mainline so that the snap rotates rapidly around the mainline, untwisting the branchline.

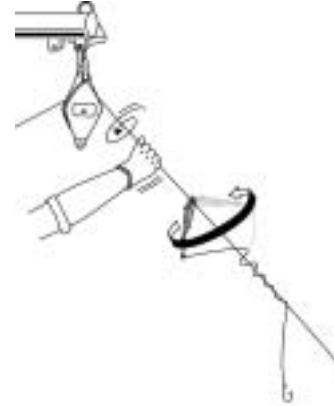

Another method is to unsnap the snap and twirl it around the mainline in the opposite direction of the tangle. The branchline and mainline are gripped together about 20 or 30 cm away from the snap and are twirled together. Then the snap is pulled away from the mainline at a right angle. This may have to be repeated once or twice to get all of the wraps off. If the branchline is badly tangled with the mainline, it is best to cut it loose. The snap and hook can be saved but the monofilament from the branchline is usually kinked and should be discarded.

Fouled hooks on the mainline can often be knocked loose without stopping the reel. When the rollerman sees a hook on the mainline he can pull the line like a bowstring and release it with a snap. This will usually cause the hook to fly off the mainline.

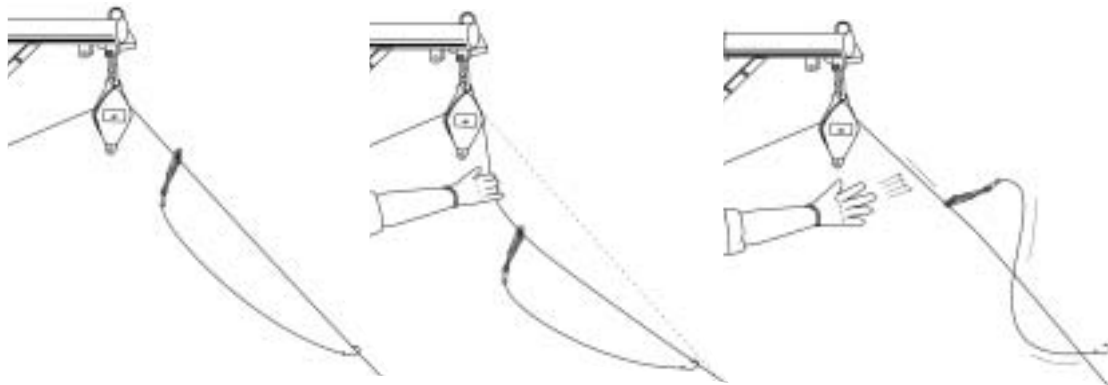

### Getting the boat off of the mainline

It is best to try to prevent fouling when the boat blows over the line. One way to do this is to round the line. The boat is turned in a tight right-hand circle while the line is kept taut with the reel. The boat continues moving until the mainline is once again off the starboard bow. Then hauling is resumed. Rounding the line is also helpful when the line is coming up from deep water or if its direction is not known. Another way to get the line out from under the boat is to reverse until the line is stretched tight off the bow. Then the boat is steamed forward and turned to port at the same time until the line is once again off the starboard bow. Care must be taken that the mainline and branchlines do not get fouled in the propeller when doing either of these manoeuvres.

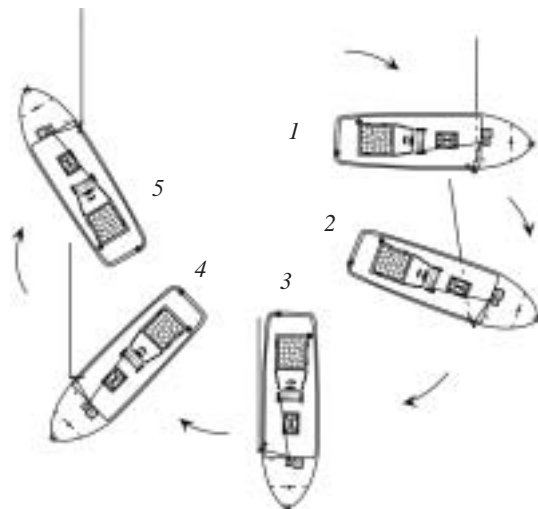

## Freeing a fouled line

If the longline gets fouled on the boat there are remedies. One is to drag a line under the boat from the bow to the stern. This can be a floatline with a 2 or 3 kg weight attached near the middle. It takes two people to do this job, one on the starboard side and one on the port side. As the weighted line is dragged, or keelhauled, from stem to stern it will pick up the mainline.

A grapple hook can also be used to free a fouled mainline. Often the line can be pulled free after it is hooked and brought on board. However, if both sides of the mainline are in hand and it cannot be freed from the part of the boat where it is fouled, the only solution is to cut the line. Often, it can be cut in one place and then the fouled portion can be pulled free. If the fouled line will not run free after being cut, then both ends have to be cut. They can be re-attached using a blood knot. The fouled section of line can be left on the bottom of the boat and can be cut out later, while drifting or while in port. It is not good to leave line on the shaft for too long, as it can cause damage to the cutlass bearing.

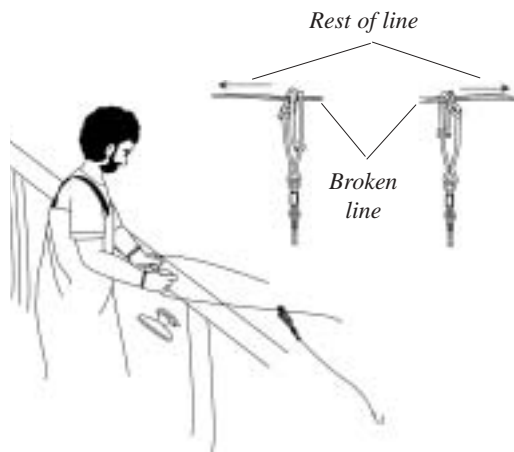

## When the line parts

If the mainline parts during hauling, then the broken end has to be located and re-attached so hauling can be resumed. As soon as the line parts, all hands should position themselves as lookouts and a search should begin. If this happens at night someone should man a spotlight. The boat should stay on the same course it was on during hauling and the spotlight should be swept from side to side, looking for the reflections from a float — floats should have reflective tape on them. If a float cannot be located it may be necessary to steam to the next radio buoy.

If the length of line to the break is short then it can probably be pulled in by hand, joined to the other end of the line, and wound onto the reel. Hauling is then resumed. If the length of line to the break is fairly long, however, it is better to cut the line free from the rest of the mainline. The rest of the mainline has to be secured to a cleat or to the rail before it is cut. The boat should be lying with the wind on the starboard side so that it does not blow over the line. The loose piece is then attached to the line

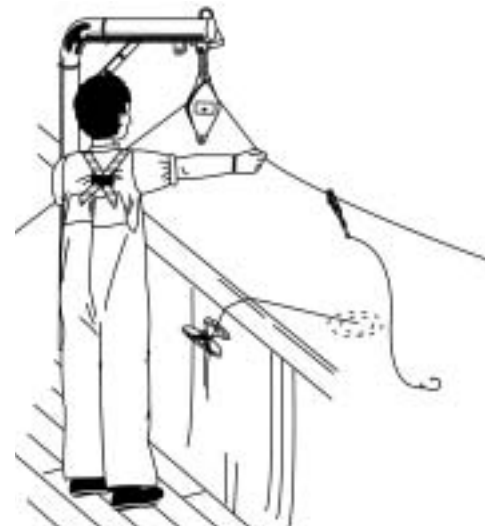

on the reel and wound in, removing branchlines as they come up. Then the two bitter ends of the mainline are joined and hauling resumes.

Alternatively, if the boat has a capstan, it can be used to haul in the broken end. In this case there is no need to cut the line. It is hauled in and piled up on the deck until the bitter end is reached, and then joined to the line on the reel. The reel then takes up the slack line on deck and hauling resumes.

## 0. FISH ON THE LINE

When a branchline has a fish on it, it should not be unsnapped until the fish is gaffed and landed. Otherwise the fish may be lost. Large active fish can be played with a lazy line, or play line — a floatline will do for this, although some boats use lines up to 100 m in length. It should be snapped to the branchline before the branchline is unsnapped from the mainline. This will allow the fish to run a little so it will tire out. Then it can be pulled in and gaffed. The bitter end of the lazy line must be tied to a cleat or to the rail. A float can be attached to the lazy line to help tire the fish out. A fish can also be played with the reel using forward and reverse on the control valve.

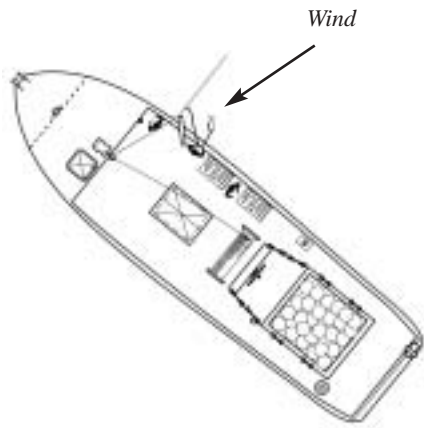

Some fishermen like to reverse when a fish comes up. This is not a good practice as most single-screw boats have right-hand propellers and they back to port. This means that when they are reversing the stern tends to swing around to port and the bow to starboard. This action would run the boat over the line and put the wind on the port side. That is what should be avoided when stopping for a fish. It is better to slow the boat as the fish is coming up and then let the wind stop the boat.

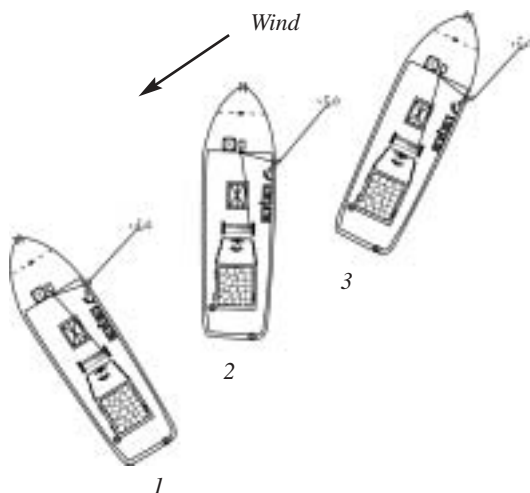

When the line has been set going downhill, initially during hauling the wind will be one or two points on the starboard bow. The wind will act as a break to stop the boat's forward motion when hauling is stopped for a fish or for problems such as tangles. When the boat is stopped the marine gear should be in neutral and the rudder should be turned a few degrees to port. The wind will end up on the starboard beam and will push the boat away from the line.

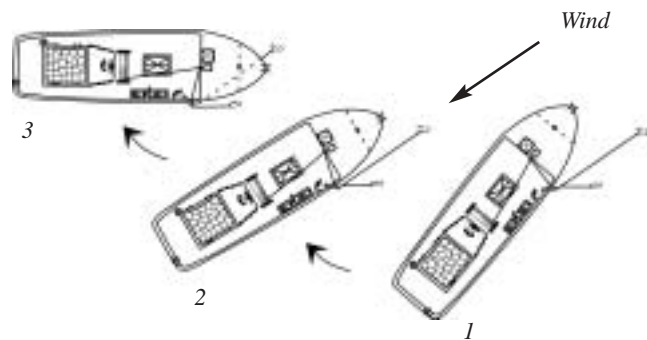

When the boat is stopped it will usually blow around so that it is lying in the trough. When hauling is resumed the boat has to get back on track. To do this the boat is steered to starboard towards the line and then gradually veered to port until it is back on track. Being on course and on track are not the same thing. If the line was set going east-west, then east is the correct course for hauling but the boat has to be in the right relative position to the mainline to be on track. The boat's course should be parallel to the set of the line but slightly to one side. The autopilot can be used to help keep the boat on course and on track during hauling. If the boat has veered off track, slight adjustments of the course can get the boat back on track. For example, if the course is 090°T and the boat is too far to port from the line, then the autopilot course can be changed to 095°T for a minute or two until the boat is closer to the line, and then back to the original 090°T.

## CHAPTER 4

# HANDLING AND PRESERVING THE CATCH

- A. *The basics and the tools needed*
- B. *Landing, killing and bleeding the catch*
- C. *Dressing sashimi tuna ready for chilling*
- D. *Dressing swordfish ready for chilling*
- E. *Dressing and loining albacore ready for freezing*
- F. *Onboard preservation: icing the catch*
- G. *Onboard preservation: CSW and RSW*
- H. *Onboard preservation: freezing*
- I. *Cleaning and sanitising*

## INTRODUCTION

This chapter describes the handling and processing side of horizontal tuna longline fishing activity, with a focus on producing a high quality export product. The basic tools needed for handling and processing the catch on board the vessel are described. The method of using the tools to kill and bleed the catch, and the methods of processing tunas and broadbill swordfish for chilling, or further processing for freezing are then described. The different forms of chilling mediums are covered with a description of their use and how to preserve the catch using each. The final section looks at cleaning and sanitising the boat after each set and at the end of a fishing trip.

## A. THE BASICS AND THE TOOLS NEEDED

Most longline caught fish are either retained whole (nothing done to the fish), or dressed in some way with parts of the fish removed. Dressed fish that have the gills and guts removed are called gilled and gutted, or G&G. Fish that have the heads and guts removed are called headed and gutted, or H&G. Fish can also be finned. That means all fins have been removed. A fully dressed fish is H&G and finned. Fish can also be cut or loined — half-loined or quarter-loined with pin bones in or out, belly flap on or off, and skin on or skin off. Loins are often called fillets.

Longline caught fish can be chilled fresh, or frozen. Frozen whole albacore for the canneries are usually finned. Frozen cannery albacore or frozen albacore quarter-loins must be kept at  $-18^{\circ}\text{C}$  or below while on the vessel and during transport to canneries or markets. Frozen G&G sashimi grade tunas must be kept at  $-65^{\circ}\text{C}$  (ultra-low temperature or ULT). ULT freezing of sashimi grade tunas is mainly carried out by the distant water Asian fleets.

All chilled fresh fish, including sashimi grade tunas, must be kept below  $4.4^{\circ}\text{C}$  but must not be allowed to freeze. The ideal temperature for fresh chilled fish is  $0^{\circ}\text{C}$ . On ice boats, fish are usually held at  $0^{\circ}\text{C}$  as that is the temperature of the melt ice surrounding the fish (Chapter 4 F). Fish kept in chilled or refrigerated seawater (CSW or RSW — Chapter 4 G) are usually at a temperature slightly below  $0^{\circ}\text{C}$ . An ice and seawater mixture has a lower temperature than a mixture of ice and fresh water. A typical RSW temperature would be about  $-0.5^{\circ}$  to  $-1.0^{\circ}\text{C}$ .

Tunas destined for sashimi markets require more care than other fish. Tunas are graded on size, colour, freshness and fat content. In addition, tunas are graded on general appearance and condition. Fish can be downgraded for gaff or meat hook marks on the body, scale loss, skin damage, bruising, bending, improper bleeding, and improper cleaning. Fish should be gaffed in the head, not in the body, and then landed gently on to a padded surface. Sashimi tuna should be stunned, spiked, double spiked with a *taniguchi* tool, bled, gilled and gutted, washed and trimmed, wrapped in mutton cloth and chilled. All of this should be done within ten to fifteen minutes of landing the fish. Tunas that are not handled properly may suffer from burnt tuna syndrome, or BTS. The Japanese call this *yake-niku*. Burnt tunas have no value as sashimi.

### Tools for handling fish

Before hauling starts, the deck should be laid out properly with all the tools and gear necessary for handling fish. The tools needed include: gaffs, fish bat, spike, *taniguchi* tools, knives, meat saw, meat hook, nylon brush, seawater hose, carpet or pad, gloves, and mutton cloth or plastic body bags.

**Gaffs:** there is a range of gaff heads available. One of the most popular is the Mustad gaff. The gaff head is attached to a pole of a suitable length for the boat it is being used from.

**Tuna missile:** is used to land large tuna. The missile is attached to a heavy line and runs down the leader where it clamps onto the tuna's head when it hits. The fish is then hauled up using the heavy line.

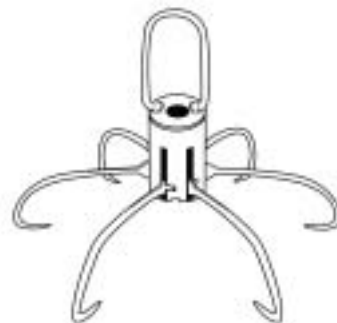

**Fish bat or club:** is used to stun the fish when it is landed. Commercial models in aluminium are available, although a piece of rounded wood with no sharp edges can also be used.



**Spike:** is used to destroy the brain of the fish after it has been stunned. A spike with a handle is easier and safer to use.



**Knives:** come in many shapes and sizes, and it is up to the individual as to which shape is preferred. A drop blood knife can be used for bleeding tuna. Other knives are used for cleaning and processing.

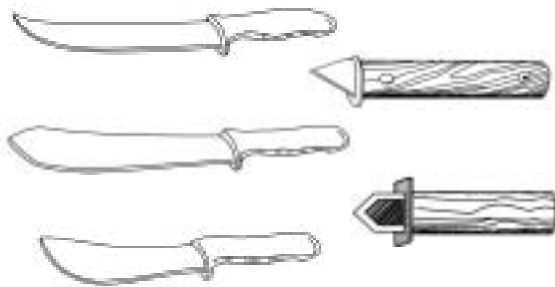

**Nylon brushes:** come in many shapes and sizes. Some are used for cleaning out the head cavity of G&G fish. Others are used for cleaning the boat at the end of each hauling session.



**Mutton cloth or plastic body bags:** are used to cover fish that are being placed in CSW or RSW, to minimise damage to the outside of the fish.



**Ice shovel:** is used on ice boats to bury fish when they are being packed in the ice hold.

**Taniguchi tool:** is inserted into the hole where the spike was inserted, and pushed down the neural canal. Taniguchi tools can be made from discarded monofilament mainline.



**Meat saw:** is used to remove the head or bill of swordfish and marlin, plus it can be used for cutting fins off larger fish.



**Meat hook:** is used to assist in landing fish and for moving fish around the deck or in the fish hold.

**Gloves:** are used by everyone on deck during hauling, especially those handling fish. A range of gloves are available.

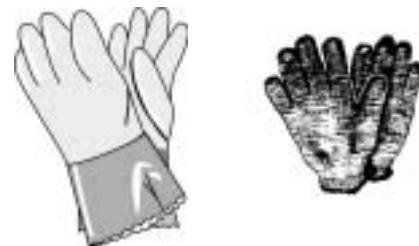

**Detergent and bleach:** are used for cleaning up the work area at the end of each trip. They are also used to wash out the fish holds after the fish have been offloaded.

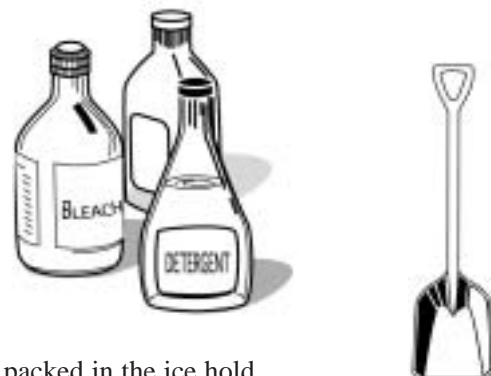

## B. LANDING, KILLING AND BLEEDING THE CATCH

When a fish comes up on the longline, it needs to be gaffed and lifted on board without damaging it. The fish should then be killed and bled, especially sashimi tuna, before it is processed ready for chilling. This section is based on the SPC manual ‘*On-board handling of sashimi-grade tuna — a practical guide for crew members*’.

### Gaffing

All fish, especially tunas and swordfish, should be gaffed in the head, never in the body. Two gaffs should be used on larger fish. The second gaff should be in the mouth. The heart and throat should not be gaffed. The heart will keep beating after the fish has been spiked. This will help get all of the blood out.



The throat should not be damaged on tunas as they will lose their shape and the meat will gape if the isthmus is broken. Gaping is when the layers of muscle in the flesh separate. If the isthmus does break loose from the jaw, it should be re-attached with a small piece of scrap monofilament line before the fish is chilled.

Tunas and swordfish should always be landed on a padded surface, never directly on the deck. The padding can be old carpet, foam mattress pads, soft rubber sheets, or burlap sacks. Landing the fish on a padded surface prevents bruising and scale loss. The crew handling fish should wear protective clothing and cotton or nylon gloves. Bare hands can leave oily handprints on a fish.



If small hand gaffs or meat hooks are used to move fish around on deck or in the fish hold, care should be taken to gaff only the head or the caudal keel, never the body. All tools used in landing and processing fish should be clean.



### Spiking and taniguchi

After gaffing and landing, if a fish is active, it should be stunned with a blow to the head by a fish bat, just between the eyes. This only knocks the fish unconscious and does not kill it. Often a fish can be calmed before spiking by covering its eye with a gloved hand.

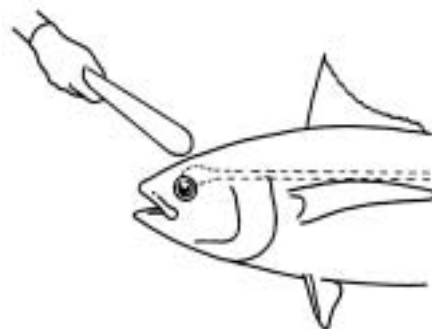

The nervous system of tunas must be destroyed by spiking and by using a *taniguchi* tool. Destruction of the nervous system prevents muscle movement and prevents BTS, where the flesh burns or turns brown. Spiking destroys the brain. The brain can be located on a tuna by looking for the soft spot on the head, just between the eyes when looking straight down on the fish. It will appear as a pale whitish spot. If the soft spot is not visible, it can also be found by rubbing the thumb over the head just between the eyes to feel it.



The fish should be held in an upright position and should be straddled by the person doing the spiking. The spike should enter the soft spot and be pushed back into the brain at a 45° angle. The fish will quiver and the jaw will go slack when it dies. This only kills the brain.

The spinal cord also has to be destroyed. This is done with a *taniguchi* tool, which is made from a 1 m long piece of 2.0 to 3.5 mm monofilament or stainless steel wire (reusable). The *taniguchi* tool is inserted into the hole left by the spike and pushed toward the tail. As it

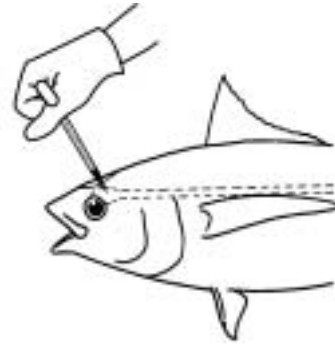

enters the spinal cord the body of the tuna will twitch, indicating that the nerves are being destroyed. The monofilament should be left in the fish with about 2 cm sticking out. Buyers prefer to see the monofilament as they know the fish was *taniguchied*; this method is also called *shime shime* in Japan.

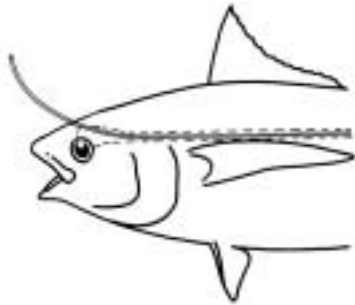

### Bleeding

To preserve freshness it is also important to remove as much blood as possible from the fish before chilling. Tunas can be bled by cutting the blood vessels that lie under the pectoral fin recess on either side. A vertical cut about 2 cm deep should be made 6 cm (three fingers) back from the pectoral fin. This should be done on both sides of the fish. A drop blood knife is useful for this.

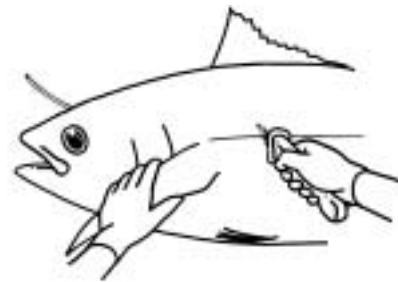

A seawater hose inserted into a cut in the gill membrane will flush the blood out. Alternatively, make cuts on either side of the throat, just in front of the heart, severing the arteries that go from the heart to the gills, and use a seawater hose stuck in the mouth to rinse all of the blood away. If fish are going to be chilled in CSW or RSW it is better to use the throat cut, as seawater could enter the side cut and damage some of the flesh when the fish is immersed in seawater. Bleeding takes five to ten minutes.



Albacore tuna are usually stunned with the fish bat and spiked to kill the brain, but are not *taniguchied*. They are also bled, usually with side cuts under the pectoral fins.

Swordfish are stunned with a fish bat if they are alive, although mostly they are dead when pulled in. If a swordfish is alive it is spiked, but not *taniguchied* and bled. Swordfish flesh is mainly consumed cooked.

Other byproduct species are usually stunned on capture, and depending on the species, spiked and bled, but not *taniguchied*.

### C. DRESSING SASHIMI TUNA READY FOR CHILLING

Once a sashimi tuna is spiked and bled, it should be dressed ready for chilling. Make a cut all the way around the gill membrane, cutting all gill attachments to the head. Then make a cut around the anal opening. (Alternatively, a cut can be made in the belly to within 1 cm of the anus and the intestines cut free of the anus.)



*Cut around gill membrane and anal opening*



*Alternative belly cut*

The gills and guts can now be removed through the gill cover in one piece. The swim bladder and the gonads should be left in the gut cavity. Some fish graders like to look at the gonads to determine the sex and stage of sexual maturity of the fish.

The inside of the head cavity should then be trimmed of all loose tissue, the blood and kidneys and any gill membranes removed.



All remaining blood and kidney should be scrubbed from the base of the skull using seawater and a nylon brush. It is not necessary to scrub the gut cavity, and the outside of the fish should never be scrubbed.

The gut cavity and body are then rinsed with seawater to remove all blood and slime, and the fish chilled immediately. If a CSW or RSW system is used for chilling, the fish should be put in a mutton cloth sock to protect the skin from chaffing.



## D. DRESSING SWORDFISH READY FOR CHILLING

Dressing swordfish is quite different from dressing sashimi tunas. The head and all fins are removed. The head is removed with a meat saw, cutting right through the second gill cover at a 90° angle to the trunk.

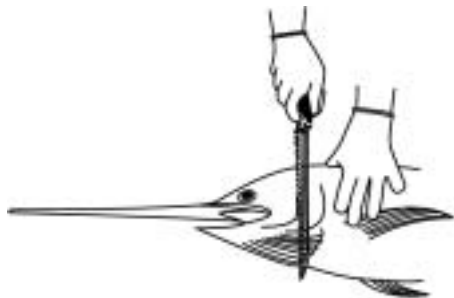

The remaining gill cover and gill arch membrane are removed with a sharp knife.



The guts are then removed, usually via the gill cavity area, and any loose tissue is removed.



The kidney and bloodvessels are cut away from along the spine and all blood is removed by thoroughly scrubbing and rinsing this area. White bone should show all along the length of the spine. All slime should be scraped away from the gut cavity with a large metal spoon or scraper and this area should be rinsed thoroughly.



Any visible parasites should be removed. The trunk should be wrapped in a plastic body bag before chilling.

Remove all fins and the tail (cut behind the caudal keel) using a knife or meat saw.

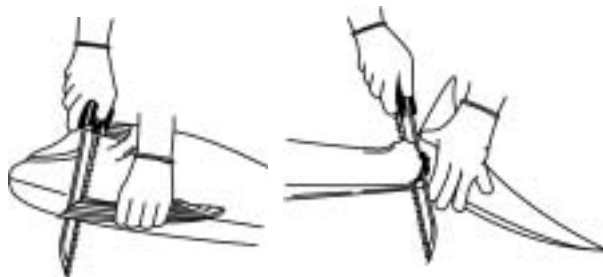

A cut is made around the anal opening and another cut made from here, forward up to but not through the pectoral girdle.

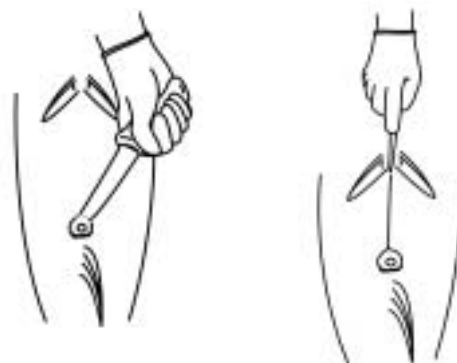

## E. DRESSING AND LOINING ALBACORE READY FOR FREEZING

In parts of the Pacific, albacore tuna make up the majority of the tuna catch, and they are targeted by fishermen in some areas. Albacore are mainly destined for the tuna canneries in the region, and they are delivered frozen. The fish can be frozen on board the boat, or landed chilled and then frozen in shore freezers before shipping to canneries. Other fish species besides albacore can be handled in this manner as well. Value-adding through loining (mainly albacore tuna) may be done before freezing. This can be done at sea or at shore facilities after the chilled catch is landed.

### Whole albacore

Preparing albacore tuna for freezing for canneries requires little processing. Some operators bleed the fish using a cut through the pectoral fin recess (Chapter 4 B), while others do not. Some boat operators do no processing, others cut the tail fins, and others remove both the tail and the pectoral fins. Fins are removed so the frozen fish stack better and take up less room in the freezer. The best approach is to check with the cannery to find out how they prefer the fish processed. The highest quality and highest value frozen albacore are bled first and then blast or plate frozen. These albacore are destined for sashimi markets in the US and Japan.

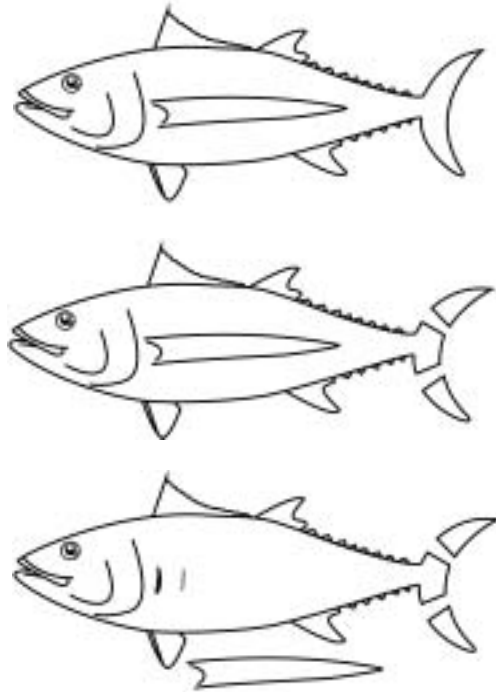

### Loining albacore

The term loining is used in two contexts in tuna fisheries. At a cannery, the first part of processing tuna is called loining: the fish are cooked, and the four loins are then separated from the skin and bones of the fish. These cooked loins are then canned.

The second context, and the one covered in this section, is the loining of fresh or uncooked fish. The loins are frozen at sea and are marketed for steaks or for sashimi. To do this the boat should be equipped with a processing room, and if the fish are to be exported, standards need to be adhered to for different markets (Chapter 5 A). The following method is used to produce processed albacore quarter-loins at sea ready for freezing.

Soon after the fish are caught they are bled and headed and gutted (H&G). This is usually done on deck with four cuts to remove the head (it can also be done in the processing room) using a large serrated knife. The first cut is made from under the pelvic fins towards the head at a 45° angle. The same cut is then made from under the pectoral fin on each side. Last is a chopping cut from the top of the head to the spine, with the head snapped away from the backbone by pulling on one of the pectoral fins.

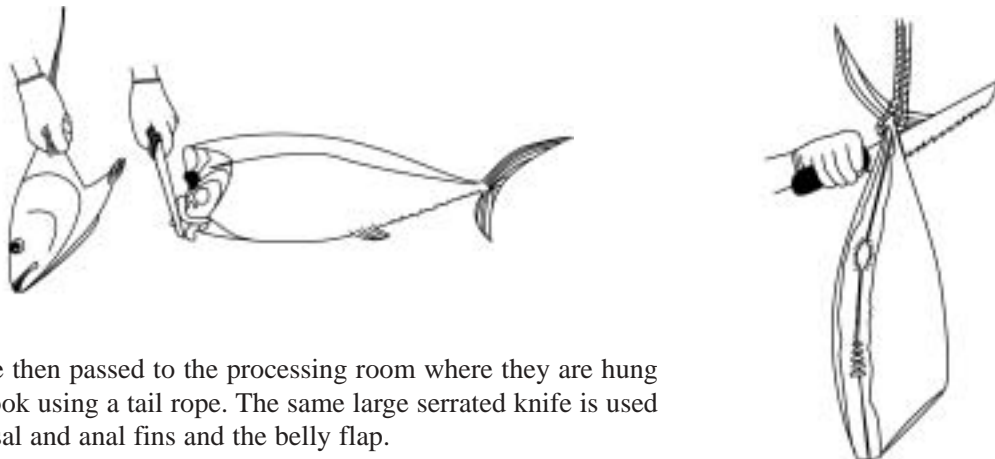

The H&G fish are then passed to the processing room where they are hung by the tail on a hook using a tail rope. The same large serrated knife is used to remove all dorsal and anal fins and the belly flap.

A filleting knife is then used to cut the flesh away from the frame, down to the backbone dorsally and ventrally on both sides of the fish. Care is taken to ensure the cut is as close to the frame as possible.



A meat hook is inserted into the tail end of the half-loin just in front of the caudal keel on the lateral line. The placement of the meat hook is important, as it must not penetrate the usable flesh. The large serrated knife is then used to cut through the pin bones as the half-loin is pulled away from the frame using the meat hook. This results in a very clean cut, leaving almost no waste on the frame. The second half-loin is removed in the same way.

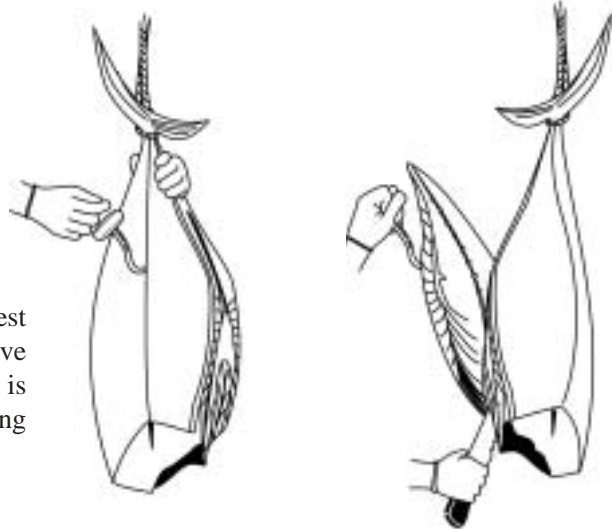

Half-loins are placed on the cutting table for the rest of the processing. A skinning knife is used to remove skin. The skin is removed in sections while the loin is lying flesh side down. This is done to avoid bending the half-loin.



The half-loin is then turned over on the cutting table. The skinning knife is used to cut away the first quarter-loin from the pin bones and bloodline.



The pin bones and bloodline are then cut away from the second quarter-loin. Rib bones are also removed from the area around the gut cavity. The result is two quarter-loins that usually only require a small amount of trimming to remove remnants of the bloodline.

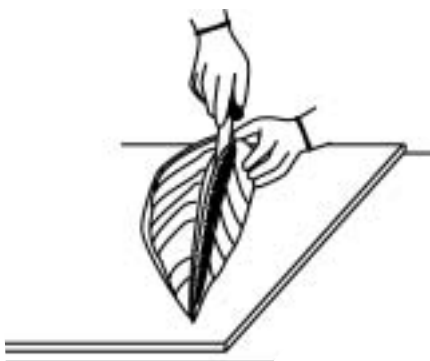

The quarter-loins are then washed and individually wrapped in plastic wrap, ready to be placed in a blast freezer.



Note: The return on this type of processing is about 50 per cent on average (a 20 kg fish would yield around 10 kg of loins). It is wise to examine the markets before deciding to loin or not. If the cannery price for frozen whole fish is half or more of the price being offered by markets for frozen quarter-loins, then it makes no economic sense to loin. On the other hand, if the price being offered for frozen loins is significantly more than twice the price being offered for frozen whole fish, then value can be added by loining at sea.

## F. ON BOARD PRESERVATION: ICING THE CATCH

Basically, there are three ways to chill or preserve fresh fish on board a longline boat: icing, chilled seawater (CSW — sometimes called an ice slurry), and refrigerated seawater (RSW). The type of preservation depends to a certain degree on the longline boat. A boat with one large fish hold would have to use the icing method, while a boat with multiple small fish holds could use either CSW or RSW. Freezers are used to preserve the catch in some locations, with fish frozen whole or processed into loins before freezing.

### Icing fish

Icing is the most difficult method of chilling fish and requires the most skill, but if done properly, produces a superior product. Fish have to be buried in ice as soon as they are cleaned and dressed. The centre bin in the fish hold, often called the slaughter bin, is usually used for the initial chilling. This is called pre-icing. Alternately, fish can be chilled in an ice slurry before icing. It takes many hours to chill the core of a large fish to 0°C. Fish are usually pre-iced overnight. The bins are usually made with removable pound boards, so that sections of the fish hold can be partitioned off as the hold is filled.

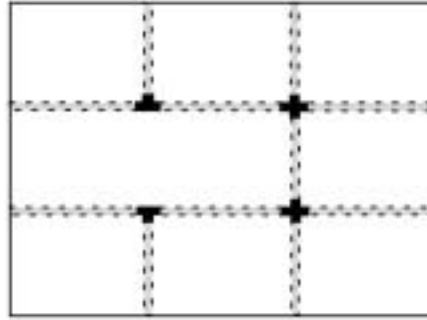

*Top view of a fish hold with removable pound boards*



The condition of the ice can affect the quality of the fish. Flake ice and shell ice both tend to freeze into clumps after several days. Before fish are buried, all ice has to be chopped into fine pieces. Large clumps or chunks of ice can leave dents and bruises on the fish.

A bed of soft ice several centimetres thick should be made in the bottom of the hold. This is called the starting layer. The thickness of the starting layer depends on the insulating properties of the fish hold and on the trip duration. Experience is the best teacher in this case, and each vessel is a little bit different. Fish are first laid out on the starting layer in a fore and aft orientation on their sides, usually with the heads pointing forward. Finely chopped ice is then shovelled over the fish.

The fish are then turned so that the backs are up and bellies down. Large fish can be turned easily. The tail is grabbed with both hands and the fish is twisted into an upright position. As the fish are turned, some ice will fall under the fish along the sides. This ice will prop the fish up while they are covered with more finely chopped ice.

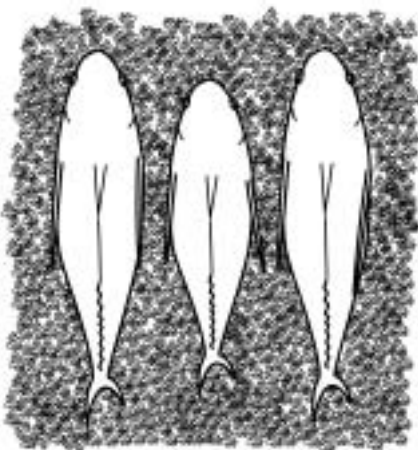
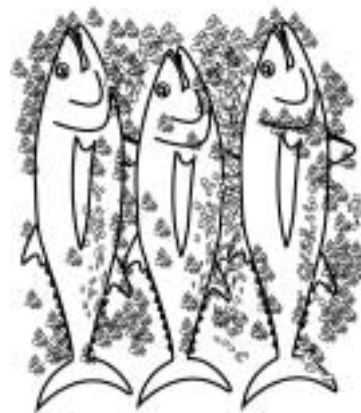

All air pockets should be filled with ice. Fish should not touch each other or the sides of the fish hold. There should be one or two cm of ice between each fish. Heads and fins can touch but not the body trunks. Finally, there should be four or five cm of ice over the layer of fish before another layer of fish is made. Usually on the pre-icing, only one or two layers of fish are made.

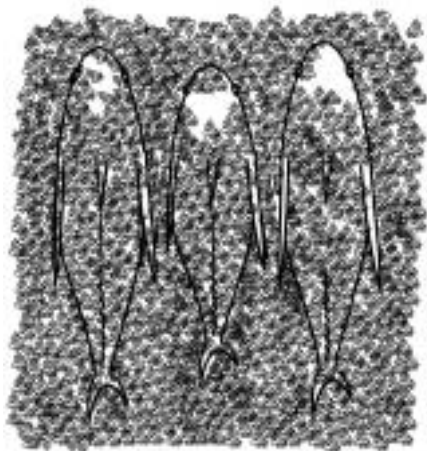

As the fish cools, ice melts and air pockets, called igloos, form around the fish. These air pockets must be removed or the fish will warm up and possibly move around, causing scale loss and bruising.

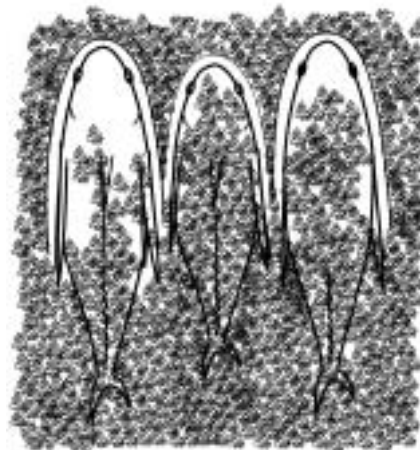

*Igloos forming around fish*

There are two ways to remove the igloos from around fish. The igloos can be broken up with a wooden stick or a shovel handle, and ice repacked around the fish. This does not work too well if the fish are already in several layers.

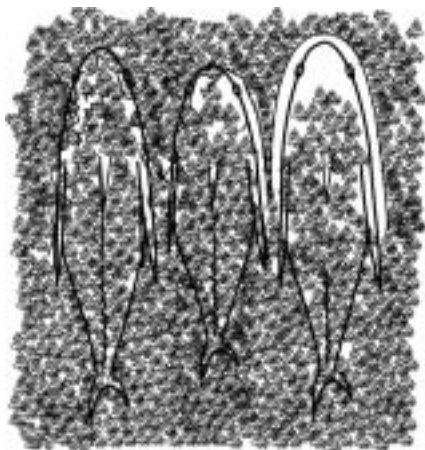

*Breaking up igloos*

The alternative is to dig the fish out of the slaughter bin and rebury them in another bin. In either case the fish have to be iced twice. After the fish are reburied, they require no more handling, as no more air pockets will form. Small fish can be buried four or five layers deep, larger fish up to three layers deep. Large fish should be put in the bottom layer and smaller fish on top. The same thickness of ice around the fish should be used as in the pre-icing. Sharks should not be buried in the same bin with other species, especially sashimi tunas.

The buried fish should be checked at least once a day. Any melt water should be pumped out of the fish hold and the top layer of fish should get a new cap layer of ice when necessary. There should be no heads or bodies sticking out through the ice — tails and fins are okay, though.

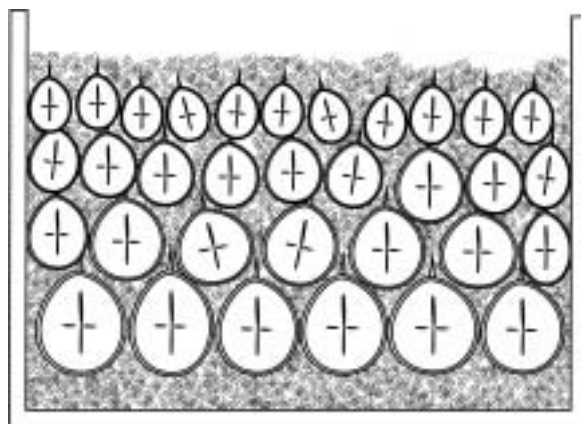

*Layers of fish — large fish on bottom and small fish on top*



*Adding ice*

## G. ON BOARD PRESERVATION: CSW AND RSW

By contrast to the icing method, preserving fish in CSW or RSW systems is easy and fast. After a fish has been cleaned and dressed, and wrapped in a mutton cloth or plastic body bag, it is simply immersed in the tank with the chilled seawater or refrigerated seawater.

CSW does require some preparation. Before hauling begins, a tank filled with flake ice must be mixed with seawater. The ice usually freezes into clumps and these must be broken up. The result should be a slurry of ice and seawater in a two-to-one ratio. An ice slurry should have the consistency of wet cement. Fish placed in a slurry will usually be suspended in the slurry to start, and then slowly sink and find their way to the bottom of the tank. As more fish are added and ice melts, more ice will need to be added to the slurry.

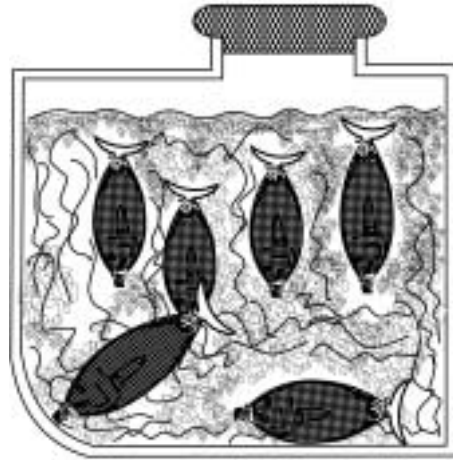

More care must be given to placing fish in an RSW tank so the fish will not get damaged on the sides or bottom of the tank. Usually, a long tail rope is used to gently lower the fish. A floatline or discarded branchline works fine for this. The line is doubled and the resulting loop or bight is wrapped around the tail of the fish but not knotted. The fish is then lowered slowly into the tank until it comes to rest. The tail rope should then slip off of the tail easily so it can be recovered.

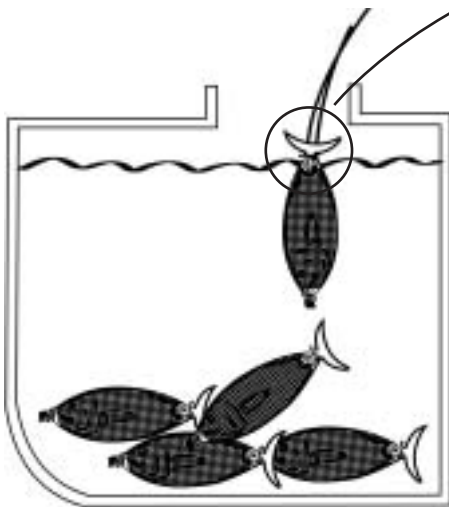
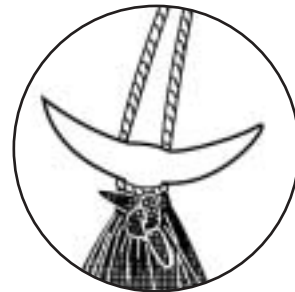

Some CSW and RSW boats suspend the fish vertically in the tank by tail ropes. Other boats have tank baffles so that fish movement is minimised. No further handling is necessary once fish are placed in a CSW or RSW tank.

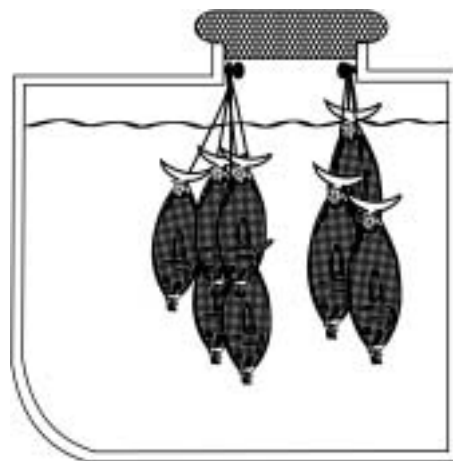

A CSW tank should always have some ice. Preferably the mixture should be stiff enough so that fish do not move around much. The temperature will be close to 0°C if there is ice in the tank. The temperature in RSW systems should be monitored several times per day, either with a built-in temperature gauge or with a hand held thermometer. RSW temperatures should be kept in the range of -0.5° to -1°C (the water in an RSW system is usually a mix of 80 to 90 per cent fresh water and 10 to 20 per cent seawater). A hand held digital probe thermometer is useful for checking RSW tanks and it can also be used to check the core temperature of fish during unloading and processing.

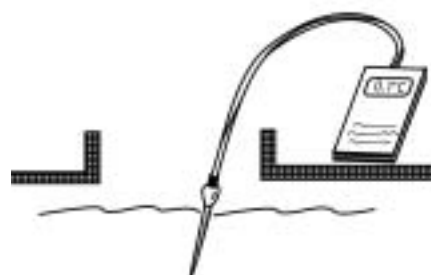



## H. ON BOARD PRESERVATION: FREEZING

Fish, whether whole or loined, should be frozen in a blast (snap) or plate freezer. Some boats have separate freezer holds where fish are stored after initial freezing. Fish are blast or plate frozen down to  $-35^{\circ}\text{C}$  or lower, and are then stored in a separate freezer hold at  $-18^{\circ}\text{C}$  or lower. For cannery fish  $-18^{\circ}\text{C}$  is usually sufficient, but for fish destined for the sashimi markets, colder temperatures are required. Fish have to be maintained at  $-35^{\circ}$  to  $-40^{\circ}\text{C}$ . Some Japanese markets require frozen sashimi to be maintained at ultra-low temperature (ULT) of around  $-65^{\circ}\text{C}$ .

Once the fish or processed loins have been made ready for freezing, they are placed on trays or shelves in the blast freezer. The spacing of the shelves is usually adjustable, to cater to the thickness of the fish or loins being frozen. The fish or loins should not be stacked on each other for freezing.

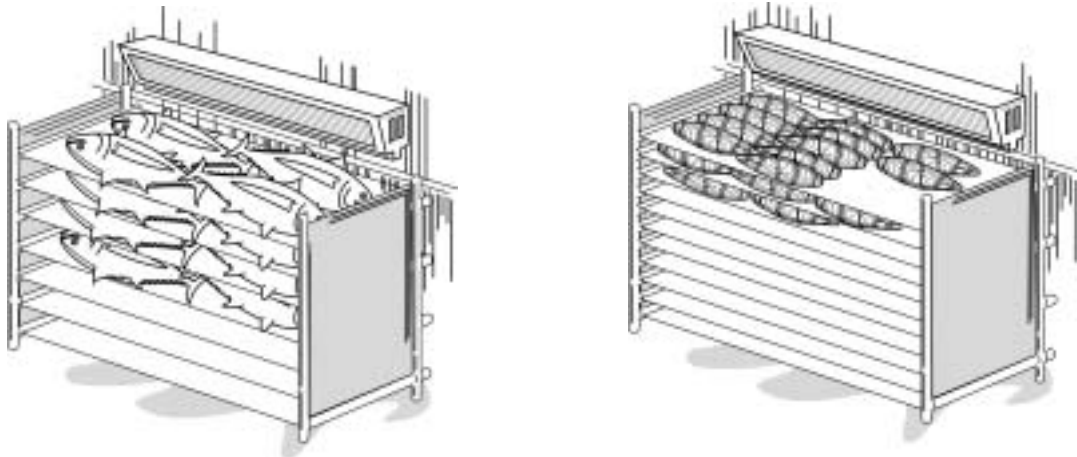

An alternative for freezing whole fish is to hang them from racks so they freeze straight. To do this, each fish has a tail rope, with a meat hook used through the tail rope to secure the fish to a rail. The rack usually has space for several rails, or rows of fish. The meat hooks can slide on the rail, so the fish can be pushed along to pack them in and reduce movement. In some cases there can be two rails, one above the other, to maximise the freezing space.



Once the fish or loins are frozen, they are transferred to a storage freezer and stacked, or stacked in the same blast freezer. Whole fish are generally stacked in rows, alternating with one head in and one head out. Once a row is made across or along the freezer, the next row is stacked on top using the same alternating method. It is best to stack fish of the same size and body shape together to maximise the use of the storage space.

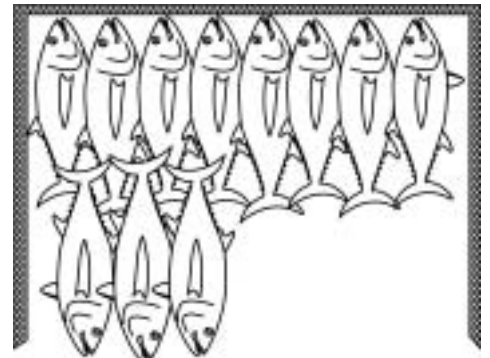

Frozen loins can be stacked similarly to the whole fish, or they can be packed in waxed cardboard cartons to reduce the chance of freezer burn (moisture loss). The cartons are then easily stacked in rows.

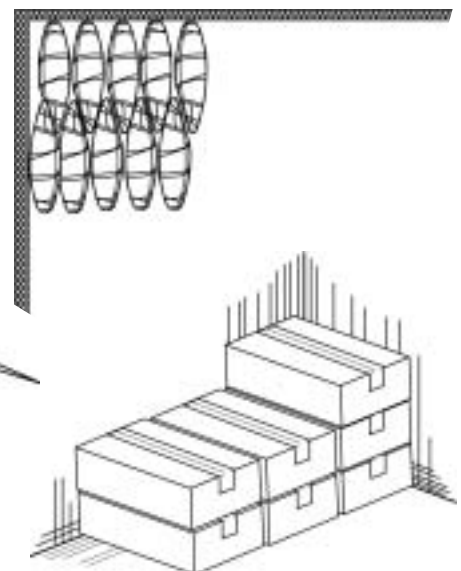
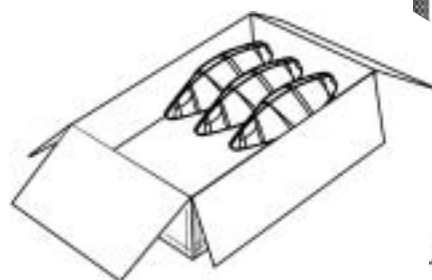

## I. CLEANING AND SANITISING

The working deck of a longliner should be kept clean during fishing operations. Blood, guts and slime should be rinsed away as fish are being cleaned, and should not be allowed to accumulate or dry on the deck or on the carpet or foam pad used for landing fish. Heads, fins, and billfish bills should be thrown overboard as fish are cleaned. At the end of each haul the deck and the carpet should be cleaned and scrubbed, using deck brushes and seawater, but no chemicals. All tools used in fish handling, including gloves, should be cleaned.



After the last set of a trip has been hauled, the working deck and all tools used to handle and process fish on board should be cleaned and sanitised. Cleaning can be done using detergent, copious amounts of seawater, and stiff deck brushes or scouring pads. Sanitising calls for something stronger than detergent. Household bleach mixed with water works well; and there are commercial preparations that work well, too. All blood, slime, scales, and bits of flesh should be scrubbed from the deck and bulwarks around the working deck. Next, every surface should be sanitised with a mixture of household bleach and water. Finally, all surfaces should be rinsed thoroughly to remove all trace of chemicals.

After the vessel reaches port and the fish have been unloaded, the same cleaning and sanitising process should be done to the fish hold and all bin boards (pound boards). Carpets and foam pads used for landing fish are often difficult to clean. They should be discarded if they cannot be sanitised.



If freezers are used to preserve the catch, these should also be scrubbed out when they are turned off, especially the blast freezer where blood or juices may have dripped out of the fish during the freezing process.

## CHAPTER 5

# MARKETING AND BUSINESS OPERATIONS

- A. *Marketing and grading in general*
- B. *Packing fresh fish for export*
- C. *Shipping and marketing export fish*
- D. *Running a longline boat as a business*
- E. *Fixed costs and the boat's accounts*

### INTRODUCTION

This chapter describes the operation of a horizontal tuna longline vessel as a business. This includes the marketing and grading of the catch, which need to be carefully thought through to meet the needs of specific markets and to maximise profits. Packing the fish for export and shipping the catch by airfreight are covered to highlight the process for people wishing to enter export marketing. The operation of the boat is also covered, looking at both fixed and variable costs and how to apportion the income from fish sales after expenses are deducted, amongst the skipper, engineer, crew and vessel owner.

## A. MARKETING AND GRADING IN GENERAL

Onshore handling of tuna for export sashimi markets is just as important as on-board handling. Care must be taken not to damage the fish and not to interrupt the cold chain. This means that fresh chilled fish should be maintained at 0° to 4.4°C not only on the boat but also during unloading, processing, packing, transporting and marketing.

The main markets for fresh sashimi grade tunas, broadbill swordfish and striped marlin exported from the Pacific are Japan, Hawaii, and the US mainland, with small markets in Korea, Australia and New Zealand. Each market has slight preferences for how the fish are received; such as Japan preferring to receive the tunas with head on (G&G), while the Hawaii market prefers H&G tunas. Also, different sashimi markets have preferences for certain species, so this needs to be considered as part of any marketing strategy.

Albacore tuna commands a good price from canneries, although the price fluctuates at times based on supply and demand, and the fish need to be frozen before shipping to canneries. Frozen albacore loins are mainly marketed in Europe and the US mainland to be further processed as steaks. There is also a growing market in the US and Japan for ULT (ultra-low temperature) frozen albacore for sashimi.

Byproduct species are generally sold on the domestic or local market, although byproduct species such as mahi mahi and wahoo can fetch good prices in some export markets at different times of the year.

### Market requirements

Most packing of fresh chilled fish for export is done at a shore based packhouse or processing facility. These establishments are set up to handle fresh fish and have the appropriate health and sanitation certification both for the local requirements and for the export markets the fish are destined for. For example, if fresh fish is being exported to the US, the packhouse needs a current HACCP (hazard analysis and critical control point) plan for the establishment.

The HACCP plan has documented all the hazard areas in the processing and packing of the fish, mainly in regard to quality and temperature control. At each of these identified points, records need to be kept on a random sample to document and show that temperature or other identified hazards are in check. If the fish are processed on a boat, such as with loining, then the boat has to have a HACCP plan and quality control needs to be documented at each identified point.

The European Union (EU) has its own requirements for marketing fresh or processed fish. The EU requires each country exporting fish to them to have appropriate legislation, and a competent authority, such as a health inspector who has access to laboratory facilities to conduct random checks on fish to ensure that the fish is safe for human consumption. The EU also has health and sanitation requirements for processing facilities. Facilities need to be certified by an EU inspector before they export fish to EU markets.

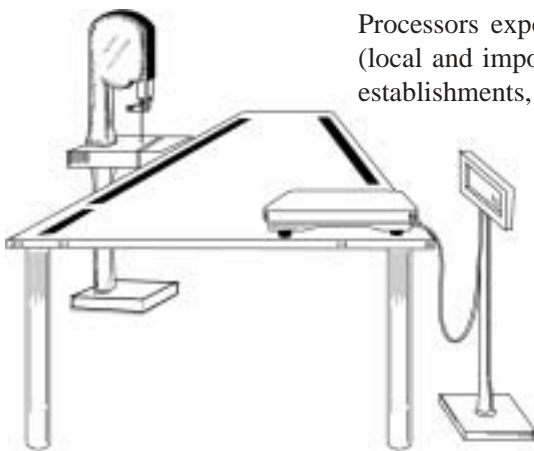

Processors exporting to the US or EU should consult all relevant authorities (local and importing) to ensure that all requirements, both for the fish and the establishments, are complied with.

### Equipment needed for packing fresh fish for export

Packhouses or processing facilities for export should have stainless steel processing tables, knives, bandsaw, meat hooks, and good accurate scales.



Fish handlers should wear rubber disposable gloves and appropriate clothing (apron, gumboots, mask and hairnet).

Export fish should be packed in airline approved insulated wet-lock cartons, and gel ice packs should be added to the cartons to help maintain the cold chain.

### Grading fresh sashimi quality tunas

Export marketing of fresh tuna is a very complex business. Freshness is the most important factor but fishermen and processors also have to consider grades of fish, market specifications, market trends and cost of exporting. All export fish should be firm and fresh. Mushy flesh is unacceptable.

Tuna is usually cut near the tail or cored either by the exporter or the buyer so that the flesh can be examined and graded. Byproduct species are not graded like tunas but buyers do look for firmness and they often examine the bloodline (dark muscle) for freshness. The bloodline should be pink or red; brown is not good.

Japan and the US grade sashimi tuna similarly, although the grades are named differently. In Japan the ranking or grading is A, (top quality) B, C, or D (reject). In the Hawaii or west coast US markets, fish are ranked or graded #1, (top quality) #2, #3, or #4 (reject), with a plus or a minus sign to indicate the presence or absence of fat. The highest grade is #1+. Hawaii grading is usually stricter than mainland US grading, and Japan grading is stricter than Hawaii grading. Some Pacific Island exporters simply grade their tunas as 'YES' or 'NO' — the yes fish get exported, the no fish are sold locally. This type of grading is better than not grading at all.

Size of tunas has a bearing on tuna grades — only larger fish can be #1 grade — approximately 30 kg whole weight for yellowfin tuna and 40 kg whole weight for bigeye tuna, but this can vary with market demands. Large, well rounded tuna are more likely to have high fat content and they give higher yields. The most important grading factor, however, is colour: red is best. Roughly, red is #1, pink is #2, pale is #3, and brown is #4 or reject grade. A rainbow-like sheen on the flesh usually downgrades the tuna. Other important factors are muscle clarity and visible fat. High-grade tunas have bright, clear flesh. The highest-grade tunas have visible layers of fat in the flesh, particularly in the belly flap.

The best way for exporters to get the highest return from export tunas is to send only fresh fish that have been graded and packed properly, and to send what the buyers want. Generally, only #1 and #2 fish are exported. If the market is good and supplies are weak, #3 fish can sometimes be exported. Lower-grade tunas are usually sold locally, frozen for the cannery, or converted to value-added products such as steaks.

### Layout of a packhouse or processing facility

The layout of a packhouse or processing facility is extremely important to ensure the smooth flow of product from the receive area to the packed cartons leaving the facility. It is best if all fish arrives at one end, is processed without any double handling or backtracking, and leaves from the other end. In some cases, a continuous flow in a 'U' shape may be needed, with the fish entering and leaving from the same area.

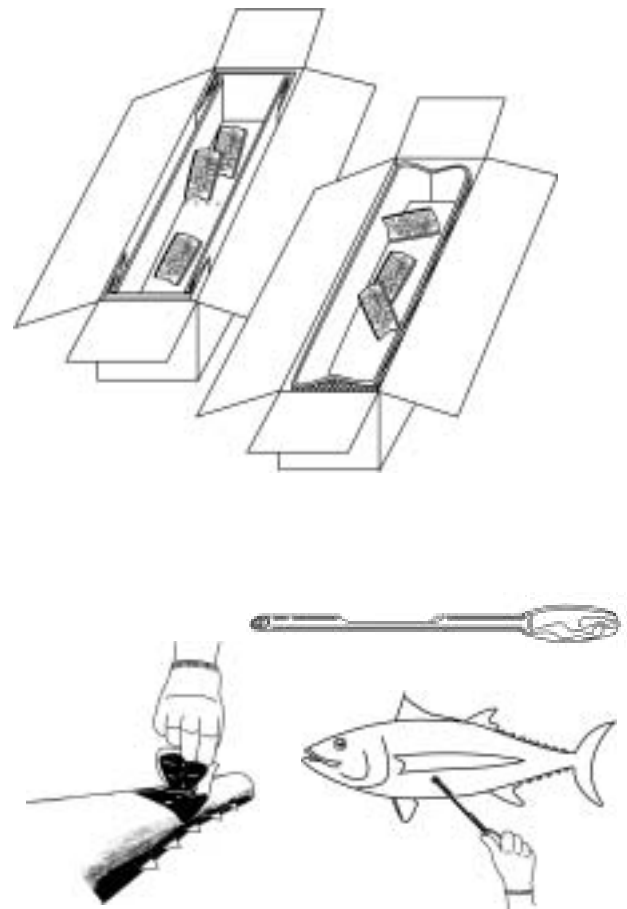
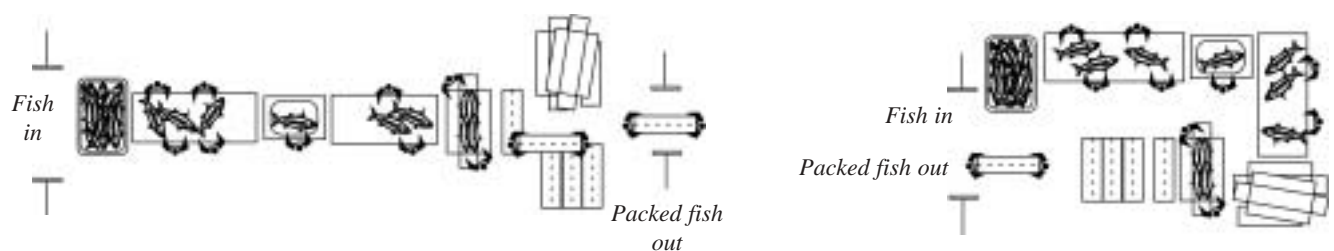

## B. PACKING FRESH FISH FOR EXPORT

Fish should not be moved around in the heat of the day. Unloading and packing should be done in the morning or evening hours when it is cooler. Fresh chilled fish that are not to be exported should be re-iced or stored in a chill room until they are sold or processed. Fish that are to be exported should be processed as soon as they are offloaded from the boat. Fish and cartons of fish should be kept out of the sun and away from other heat sources. They should not be dropped or thrown.

The catch from longline boats is often unloaded directly to a packhouse or processing facility. When this occurs, the fish are placed in portable insulated storage bins onshore, with ice or ice slurry to maintain temperature. The bins are transported into the packhouse by forklift. If, however, the fish has to be transported from the wharf to the plant by truck, they should be transported in a refrigerated truck, or the truck bed should be iced, or the fish should be transported in portable insulated storage bins with ice or ice slurry.

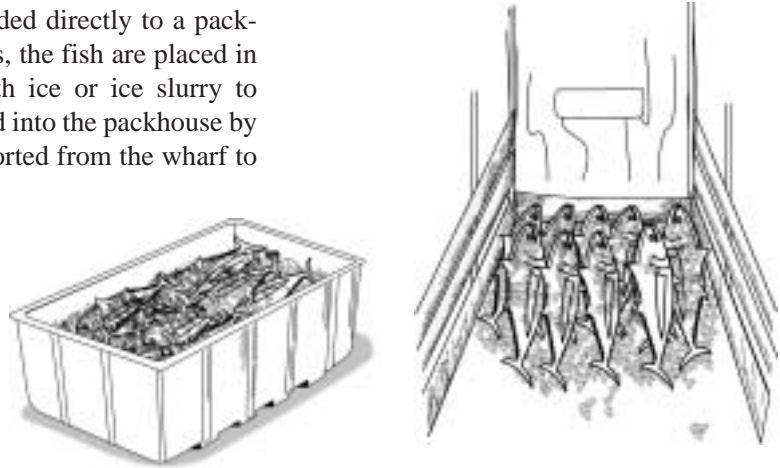

Once the fish are in the packhouse, the area should be closed off to stop insects entering and to maintain a cool working temperature. The fish are placed individually on the table, the mutton cloth or body bag removed, and they are rinsed off with cold (0°C), clean fresh water. Water for rinsing fish can be chilled in several ways. One way is to have coils of copper pipe mounted in front of a chiller unit. Another way is to have copper pipe in an insulated bin of ice slurry. The water is chilled as it passes through the copper pipe.

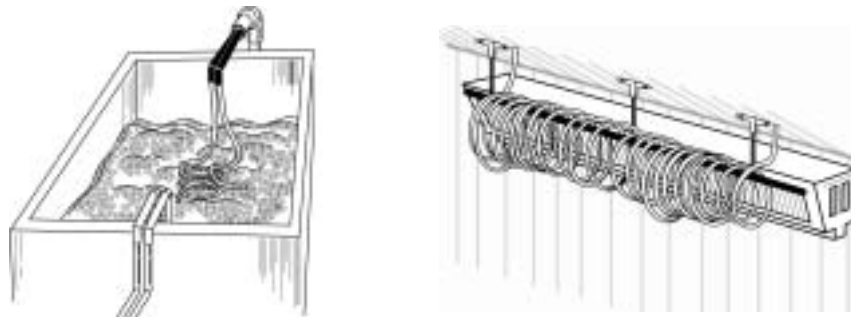

The fish are then graded and weighed, with the weight recorded on a piece of paper. The paper is then placed on the gill cover, the fish's side, or in the belly cut. Export fish are then ready to be packed in cartons. Generally the same species are placed in the one carton, with up to four fish depending on size and weight. Large fish are packed individually and may need the tail cut off to fit it into the carton. All fish are packed back down and belly cavity up.

Packs of frozen gel ice are added to the box to assist in maintaining temperature. Usually one pack (1 kg) of gel ice is used for 10 to 20 kg of fish. At least one gel ice pack is placed in the gill cavity or belly of large fish.

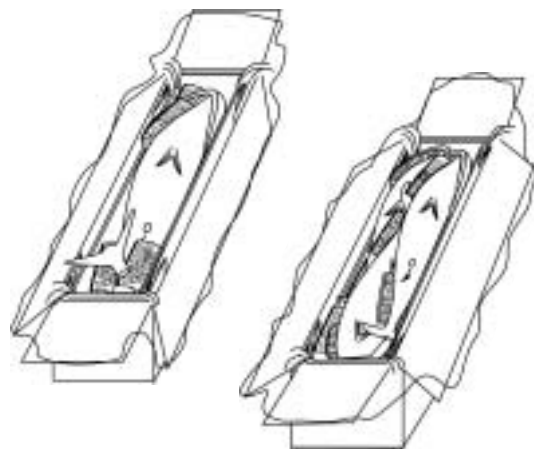

Each carton is then sealed, by first closing and sealing inner plastic or insulated linings, and then the cardboard flaps. Cartons are either strapped or taped to ensure the lid is secure. Each box is then weighed and clearly marked with the company name, destination, species and individual weights of each fish and the total weight of the box, with each box numbered for future reference. The sealed cartons are then stored in a chiller, either loose or on a pallet, or loaded directly into a refrigerated truck or into an airline container, ready to be transported to the airport.

## C. SHIPPING AND MARKETING EXPORT FISH

Exporters should keep in close communication with fish buyers or brokers so they know what the export markets are doing. If there is a glut of yellowfin tuna in Japan in April, for example, then it may be better to send yellowfin to the US that month. Exporters should be aware of individual market preferences. The Honjo Market in Osaka, for example, prefers yellowfin tuna to bigeye tuna, while the Tsukiji Market in Tokyo prefers bigeye tuna to yellowfin tuna. The market for sashimi tuna has definite seasons as well. For example, just before Christmas and New Year's Day are the best times to market sashimi tuna, while the months of June and July can be the poorest times.

Once all the fish have been processed and packed, the exact details of the consignment are known for each shipment. Airfreight space is generally booked in advance, to ensure the fish can be exported as scheduled. Some countries require the presence of Fisheries or Customs Officers during the processing and packing stage to verify product and quality of product. All Customs and Fisheries forms should be completed.

The cartons of fish should be transported to the airport in a refrigerated truck as close to the time of cargo loading as possible, or if there is refrigerated storage at the airport, the consignment can be taken out earlier and stored. Alternatively, the cartons of fish can be taken from the chiller and stacked into a standard airline cargo container, such as an LD 3 container (holds roughly 1 mt of product). These containers can then be trucked to the freight area at the airport. The cartons can also be loaded into an airline cargo container at the airport.

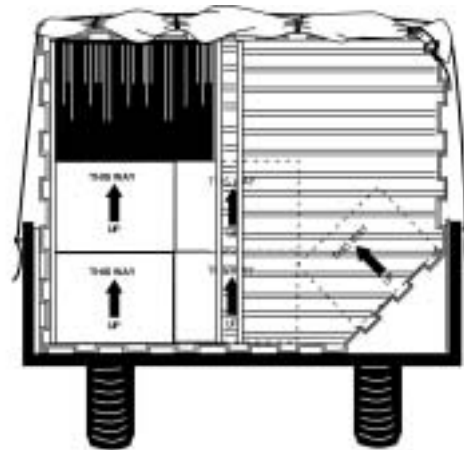

The final step is to complete an air waybill for each consignment. The air waybill contains all the details of the importer, exporter, number of cartons, gross weight of each carton and the route the consignment will take. The importing agent is then notified that the consignment is on its way, with all necessary documents faxed through to ensure the fish is cleared quickly through Customs and gets to the market in the shortest time and best condition.

### Some tips for exporting and payment

Availability of affordable airfreight space is probably the most important factor in deciding whether or not to attempt to export fresh tuna. Countries and territories that have well developed tourist industries have good airfreight links to sashimi markets, as they have regular planes going to Japan and the US. Air cargo is the biggest component of marketing costs in a fresh fish export operation. If the marketing costs for exporting fish are going to be 50 per cent or more of the market value of the catch, then it is probably not worth exporting the fish. It would be better to sell the fish locally.

Longline fisheries in countries with little external air traffic will find it difficult to enter the export sashimi business. Fisheries dependent on charter flights to get their fish to markets will also have difficulties. The minimum payload for a charter plane is about 15 to 17 mt.

Freight forwarders can be helpful to fish exporters. They can prepare documentation, obtain clearances, and pre-pay fees associated with the shipment of fish. Freight forwarders can also obtain very competitive freight rates as they deal in bulk bookings. Each shipment of fish exported must have a complete set of documents. These may include air waybill, pro forma invoice, packing list, certificate of origin, and HACCP documentation.

Most overseas seafood business transactions are done with open accounts using telegraphic transfers, or TT. Letters of credit are not as convenient.

Operators should always have enough operating capital to carry on while waiting for revenues to come in. Terms of payment from the fish buyer might be 30 days while terms of payment required by the freight forwarder might be only seven days. If the fish are sent cost, insurance, freight, or CIF, then the exporter is responsible for paying the airfreight bill. If the fish are sent FOB (free on board), then the buyer pays the airfreight bill.

## D. RUNNING A LONGLINE BOAT AS A BUSINESS

### General principles

A commercial longline fishing boat can be a part of a company owned fleet or can be an independent business, operated by an owner-operator captain, with some variations in between these two extremes. This section deals with small-scale operations such as single boat companies or owner operated boats, not with large fleets. They are another matter altogether.

Basically, there are two elements in the business of a commercial fishing operation, the boat and the crew. These two elements work together for one goal, to catch fish and make money. In order to do this they must keep expenditures low while trying to keep revenues high. One way to ensure this is to distribute the revenue on a crew-share basis. That is, everybody shares in the risk and in the net proceeds and everybody has an incentive to perform well.

In a crew-share operation, the business of the boat should always be kept separate from the business of the crew. This is true even with a one boat, owner operated company. In this sense, a fishing boat is unique as a business. What this means is that there are always two sets of books and two accounts: one for the boat and another for the crew. It is important that these two do not get mixed up and that money from the two entities does not get co-mingled. The boat, or company, consists of the owner of the boat, the boat, and all equipment and fishing gear, while the crew consists of the captain, engineer, and deckhands. In an owner-operator situation the captain belongs to both entities but he still needs to keep the accounts separate.

The reason that there has to be two sets of accounts for a fishing operation is that there are two sets of expenses, or costs, and there is a clear division between these two. They are usually called operating costs and fixed costs. Operating costs are often called shared expenses. That is, they are the costs of running the fishing operation and they are shared between the boat and the crew in some sort of pre-arranged manner. Fixed costs, on the other hand, are solely the responsibility of the boat. They are company expenses and are not shared by the crew. Another difference between these two types of costs is that operating costs are usually met at the end of each fishing trip while fixed costs are met on a monthly, quarterly, or annual basis. Each fishing trip, from the crew's point of view, is a separate business venture that has a definite beginning and end, while the boat's business is ongoing for the life of the company.

Before a boat leaves for fishing there is an agreement between the boat and the crew. The boat (or company) agrees to risk its capital (the boat and equipment) and some up-front expense money (or credit) to meet the operating costs. The crew agrees to risk their time, labour, and possibly life and limb. Both enter into this agreement for the same end result: to catch fish and make money. Both also agree that before any money can be made, all operating costs have to be met. In some operations, where fish are exported, cost of marketing the fish is considered an operating cost and is shared by boat and crew. After a break-even point is reached in the fishing trip, money will be earned that can be shared. Unfortunately, there is a complication — the market forces that set the price of fish have no relation to the cost of producing the fish or marketing the fish. Fishermen are, thus, price takers. The results of their efforts may not be enough to pay expenses. In this case the boat and crew do not get paid.

### Operating costs and crew payment: an example

A longline boat makes preparations for a two to three week fishing trip. During the turnaround time, the engine oil was changed and the fuel tanks were topped off. Extra engine oil was also purchased. The total fuel bill (diesel fuel and motor oil) was \$10,000. Fuel and oil were obtained on credit from the local oil company on the boat's account. Bait and ice were also supplied on credit by a local fish processing outfit. The cost was \$4000 for bait and \$2000 for ice. \$500 worth of replacement fishing gear, a carry-over from the previous trip, had been purchased on credit from a local fishing supply store. Certain expendable spares were also purchased including fuel filters and oil filters, light bulbs, tape, gloves, lubricating spray, cleaning materials, etc., amounting to \$500. Lastly, \$1000 of company money was spent on food for the crew. Total operating costs for the trip were, therefore, \$18,000 (Table 5). That is, the fishing operation would need to have revenues of \$18,000, after marketing expenses, to break even.

Before leaving, the boat and crew agreed on a formula for dividing the proceeds of the trip. They agreed that after all fish were sold all of the operating costs would be paid first and then the balance of money, if any, would be divided equally between the boat and the crew. This is a 50/50 split. Some boats operate on a 60/40 split or some other arrangement (see below).



The crew also agreed on how they would divide their portion of the proceeds. They agreed to divide their money into shares. The captain would get two shares, the engineer one-and-a-half shares, the two experienced fishermen one share each, and the novice, or green, fisherman, one half share. Total crew shares would, therefore, be six.

The trip lasted fifteen days during which the longline was set and hauled ten times. A total of 12 mt of saleable fish was caught — some fresh bigeye and yellowfin tuna for export sashimi markets, some albacore tuna for the canneries, and some byproduct species for the local market. The average price received for all fish sales was \$6.00 per kg. Total gross revenue for all fish was, therefore, \$72,000. Marketing costs, which included transport, processing, air-freight for fresh fish, surface freight for frozen cannery fish, export and import fees, and agent commissions totalled \$22,000, leaving a balance of \$50,000. After deducting all operating costs there was a net of \$32,000. This amount was divided equally between boat and crew, each receiving \$16,000 (Table 5).

The crew's share of the proceeds was divided into six equal shares of \$2666.67 ( $\$16,000 \div 6$  shares). The captain received two shares, or \$5333.33. The engineer got one-and-a-half shares, or \$4000. Each experienced fishermen got one share, or \$2666.67, while the green fisherman received a half share, or \$1333.33 (Table 5). At this point the crew's account was finished and the reconciliation for the trip was complete. In this type of situation, members of the crew may be considered self-employed independent contractors and not employees of the company. As such, they would be responsible for any personal income tax due on money earned. Tax requirements vary depending on local laws and regulations.

**Table 5: Reconciliation of all operating and marketing costs, and crew wages based on shares**

Item	Cost in dollars
<b>Operating costs</b>	
Fuel and oil	10,000.00
Bait	4,000.00
Ice	2,000.00
Fishing gear	500.00
Spares	500.00
Food	1,000.00
Total	18,000.00
<b>Gross revenue</b>	
12,000 kg @ average price of \$6.00/kg	72,000.00
<b>Net proceeds</b>	
Gross revenue	72,000.00
Less marketing costs	22,000.00
Balance	50,000.00
Less operating costs	18,000.00
Net	32,000.00
50% net to boat	16,000.00
50% net to crew	16,000.00
<b>Crew shares</b>	
Six shares each of \$2,666.67/share ( $\$16,000/6$ shares)	
Captain 2 shares	5,333.33
Engineer 1.5 shares	4,000.00
Fisherman 1 share	2,666.67
Fisherman 1 share	2,666.67
Fisherman 0.5 share	1,333.33
Total shares	16,000.00

Note: Typically, a reconciliation will show much more detail than that presented in Table 5. It will include the name of the boat, names of the crew, and all operating costs including names of vendors. Often details of all fish sales are included in the reconciliation, showing weight and price of each fish and the name of the buyer, with notes on the condition of the fish that affected the price. The boat and the captain should have each received a copy of this reconciliation.

## E. FIXED COSTS AND THE BOAT'S ACCOUNTS

In the example in the previous section, the boat's share of \$16,000 went directly into the company account. From this account the company has to meet all fixed costs. These include mortgage and interest payments for the purchase of the boat (or lease payments if the boat is on charter); insurance for the hull, machinery, and fishing equipment; taxes; license fees; wharf fees; depreciation; and all management fees, if any. The owner, whether he is the operator or not, may charge the company for his time spent on shore making arrangements for each trip and for sale of the catch. He may have a small office with telephone and fax, and may even have a secretary. The owner's salary, telephone and fax, rent on the office, and the secretary's wages are part of the management fee.

Most of these fixed costs are paid on a monthly, quarterly, or annual basis so they are covered by more than one fishing trip. A boat may make two or even three trips per month, in which case each trip will contribute something towards the fixed costs for that month. Any money left after all fixed costs have been met is profit for the company. Unlike the accounting for each separate fishing trip, the boat's account is ongoing and is usually reconciled with the bank and other creditors, investors, and the tax office at the end of the fiscal year. The crew, unless the operation is owner operated, is not usually privy to the boat's accounting and business.

Eventually the boat and equipment will need replacing. Money is held back from payment of company dividends to account for the wear and tear on the boat and equipment over a set period of time, usually about ten years (depreciation). At the end of the life of the boat the company should have accumulated enough money, theoretically, to purchase another boat. Sometimes depreciation is a figure that is put on the books for accounting and tax purposes but it is not actually paid into an account. In that case it is a cashback cost. In other words, depreciation is subtracted and then added back. Each time this happens the insured value of the boat is reduced, as is the tax base.

In addition to all of the above, a company may hold back a certain percentage of its share for a maintenance reserve. From time to time boats will experience breakdowns that are more serious than routine maintenance problems. A main engine may need replacing. This can cost several thousand dollars and is usually not fully covered by marine insurance. It is prudent for a company to have a fund so that they will be prepared for this eventuality. For a mid-sized longliner a maintenance reserve fund should be in the order of at least the replacement or rebuild cost of the main engine. Some companies consider this to be a shared cost and deduct one or two per cent off the top of revenues from each fishing trip before operating costs are deducted. This money is put into a separate maintenance reserve account, not the company's main account.

### Advantages of a crew-share approach to wages

There are several advantages to operating a fishing boat on a crew-share basis in the manner outlined in Chapter 5 D. First of all, everybody is working toward a common goal — to catch fish and make money. Fishing is not a nine-to-five job. No fish, no money is the rule. Conversely, the more fish you catch the more money you earn.

There is a direct incentive, with this type of arrangement, for the crew to catch as much fish as possible, in the shortest time, with the least amount of expense and wear and tear on the boat. The incentive goes beyond just tonnage of fish. There is also an incentive to preserve the fish in the highest quality condition so that they will fetch the highest possible price in the market. The crew has an incentive to handle all fish properly if they are being paid based on revenue.

The crew also has an incentive to be economical with supplies if they are sharing the costs. They are less likely to waste fuel, ice, bait, gloves, fishing gear, spares, etc., if they have to share the cost of their replacement. Furthermore, they have an incentive to maintain the boat in the best possible condition. A well maintained boat will be likely to catch more fish and earn more money than a poorly maintained boat. It will be able to spend more time at sea and will have fewer breakdowns and shorter turnaround times in port.

By contrast, longline operations that are based on fixed wages for the crew or on payment by effort or tonnage usually experience problems — there is little incentive for the crew to perform well. Large industrial fisheries such as the purse seine fishery for cannery tuna can get away with paying the crew based on tonnage. The price for the fish is set by the canneries and, except for reject fish, does not fluctuate much over a short time period. A purse seine boat will know about what they are going to earn just based on what is in the fish hold. The albacore longline fishery for cannery fish is similar: there is little short-term price fluctuation.

The longline fishery for sashimi grade tuna, however, is quite different. Every fish has its own price based on a number of factors including demand, time of year, size, fat content, overall appearance, flesh colour, flesh quality, etc. How the fish was handled has a direct bearing on the appearance and flesh colour and quality. On the same day at the major fish auctions in Japan the difference in price between two fish can be several dollars (hundreds of yen) per kilogram.

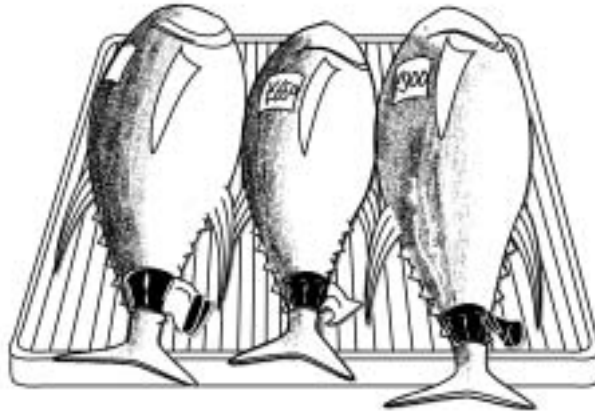

A tonne of poorly handled bigeye tuna is not worth as much as a tonne of top quality bigeye tuna. If the crew is being paid based on tonnage, however, a tonne of poorly handled fish will be of the same value to them as a tonne of top quality fish. In this case the boat will lose out on the difference. If the crew is being paid wages for their time or by fishing effort it would not really concern them if they caught any fish or not; they would be paid just the same. In fact, their jobs would be easier if they did not catch fish. The main reason that government operated commercial fishing ventures usually fail is that the crews are paid government salaries (and they are used to working nine-to-five).

Some longline operations in the Pacific have had success using a compromise between wages and incentives. They usually offer a base wage and then a bonus on top of the base that is calculated on revenue. This arrangement is attractive to crew because they know that they will have something at the end of the trip. There is less risk for the crew but they also miss out on real bonanzas when the catch is good and there is a big demand that drives prices up. On the other hand, they never go home empty handed.

In this type of arrangement there is an incentive for the crew to handle the fish properly, as they will receive a larger bonus if the price of the fish is higher. Some companies treat the base wage of the crew as an operating expense and throw it in the basket with fuel, ice, bait, etc. Obviously, there are many variations to how a longline operation can handle distribution of revenue, but the crew-share method seems to have been the simplest, most successful and most popular throughout the world.

### Working capital

A common mistake some start-up operations make is to assume that every thing will go according to the proposal they sent to the bank. There have been cases of exporters getting nothing but an airfreight bill for a shipment of fish. To be ready for all contingencies, a longline fishing and export operation should have enough working capital to finance at least two or three fishing trips and two or three export shipments.

## CHAPTER 6

# RESPONSIBLE FISHING

- A. *Marine debris and derelict fishing gear*
- B. *Bycatch from tuna longlining*
- C. *Releasing hooked turtles alive*
- D. *Avoiding seabirds and bait loss*
- E. *Depredation by toothed whales*
- F. *Recording catch and effort data*
- G. *Recording and reporting tagged species*
- H. *Observers and port samplers*

## INTRODUCTION

This chapter describes the various areas that fishermen can and should be responsible for, especially in regard to the environment and the recording and releasing of unwanted species. Marine debris and derelict fishing gear is covered, highlighting the destruction that plastics and oils can cause to the marine environment as well as the problems they cause with marine animals, especially endangered or protected species. The bycatch issue is also examined, with ways suggested to reduce interactions with unwanted or protected species. The correct handling procedures, in the event that a turtle is caught, are described along with ways to reduce bait loss caused by seabirds. The importance of recording all catch and effort data is summarised. Working in cooperation with observers and port samplers who collect tuna longline data is also emphasised.

## A. MARINE DEBRIS AND DERELICT FISHING GEAR

Marine debris is a worldwide problem that needs to be addressed by all people, while derelict fishing gear in the marine environment is a more specific problem created by fishermen.

### What is the problem?

**Fishermen and boat operators** may not be aware of the serious consequences of dumping oil, plastic and other garbage overboard. The ocean has long been seen as limitless and able to absorb anything that is dumped or discharged into it. While much marine debris is washed, blown or dumped from land, a lot is generated from boats.

**Plastics, oil and other debris** can represent a threat to the environment for many years — in some cases hundreds of years — and can injure and kill marine life. They can also endanger humans, damage boats, and cause serious losses to the tourism industry.

### How long does it take to break down?

Many items of marine debris, especially plastics, take a long time to break down and may be lying around our beaches and reefs for years to come.

### Why should fishermen care?

The thoughtless disposal of garbage and oil from vessels is bad because it can:

- kill fish, sea turtles, dugongs, corals, invertebrates and other marine species;
- spoil the appearance of beaches, mangroves and reef flats for everyone;
- block cooling water intakes, which can damage boat engines, resulting in costly repairs; and
- foul propellers and disable vessels.

### What can fishermen do?

It is up to each fisherman and boat owner to take responsibility for ensuring his vessel does not pollute.

This can be done by making sure that:

- crew and passengers know that throwing trash overboard is wrong and against the law;
- notices are displayed on board that explain how and where garbage should be disposed of;
- plastic trash is separated from other garbage and carried back to shore to be disposed of;
- a drip pan is fitted under the engine rather than letting oil leak directly into the bilge;
- oil absorption materials are also placed in the bilge to absorb all oils and fuel;
- oil leaks are fixed before they drip into the bilge;
- old engine oil is transferred into a container and properly disposed of on shore; and
- detergent is not used to clean up oil in the bilge (this only disperses it more).

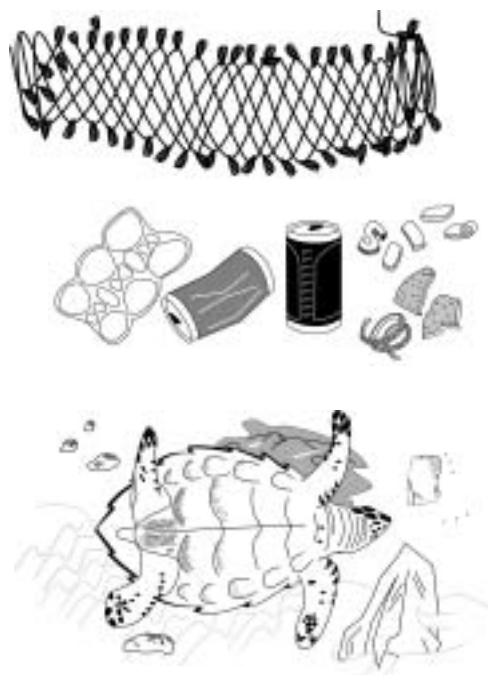

### What types of garbage are bad?

#### Plastic

Plastic is the worst kind of garbage. Because most plastics float, they can be carried hundreds and even thousands of miles by ocean currents and winds. Plastic is used for all sorts of purposes on boats, including containers and fishing gear. Such items all have one thing in common: nature has a hard time breaking them down.

Plastics found on most types of boats include:

- fuel and oil containers;
- plastic bags and sheeting;
- fibreglass;
- disposable cups, plates and eating utensils;
- drink bottles and other containers; and
- six-pack rings.

Additional plastic products found on tuna longline boats include:

- monofilament line and possibly bait netting;
- ropes and twines;
- lightsticks used for swordfish;
- plastic and styrofoam floats; and
- bait box strapping.

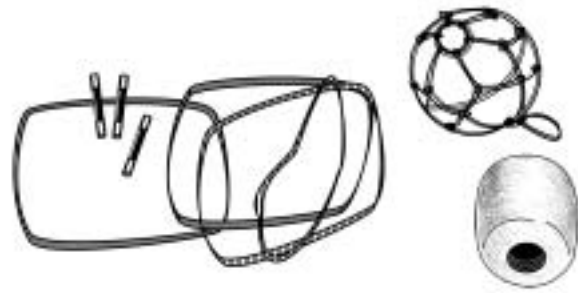

#### *Oil and oily waste*

Inboard engines tend to leak oil into bilges over time, and sump oil is sometimes drained directly into the bilge. When oil accumulates in the bilge and is pumped out — whether at sea or dockside — it causes damage to reefs and other marine life. Do not use detergent to break down the oil as it only causes it to sink when the bilge is pumped, where it will harm marine life on the seabed.

Ships running aground provide the biggest potential risk of marine pollution, when massive quantities of oil, diesel, and other contaminants can be released directly into the ocean.

#### *Other garbage*

Many beaches and reefs are strewn with marine and other debris, including, beer bottles, tin cans, tyres, light bulbs, old shoes, hospital wastes etc.

### **What happens to the garbage and oil you dump overboard?**

- Sea turtles often mistake plastic bags and balloons for one of their favourite foods — jellyfish. When they do, they die because their guts become blocked.
- Marine animals such as whales, sharks and dolphins see bait box straps and six-pack packaging rings as items of curiosity and become tangled up or strangled to death as a result of ‘playing’ with them.
- Seabirds eat small plastic pellets and bits of styrofoam mistaking them for food such as small fish, which can cause the birds to die.
- Seabirds and other marine animals can end up with plastic beverage rings around their necks, and slowly strangle to death.
- Fish, turtles and other marine animals can get entangled in derelict fishing gear such as gill nets; this gear can continue to catch fish many years after being lost or discarded.
- Marine animals that encounter nets and other fishing gear may drown, lose their ability to catch food, and be more susceptible to disease and predators.
- Seabirds that get covered in oil often die because when they try to clean themselves they ingest some of the oil, which poisons them. The oil also destroys the insulating and waterproofing properties of their feathers.
- Oil can destroy seagrass beds, mangroves, corals, crabs and lobsters, giant clams and trochus and other reef organisms by smothering them and cutting off light and oxygen necessary for their survival.

### **The garbage you throw overboard may ruin your boat or cost someone else his life**

Items such as rope, fishing line, and plastic bags can easily get tangled around boat propellers and block cooling water intakes, causing major damage and expensive repairs to vessels. With no working engine, a boat and its passengers may drift with no hope of rescue.

#### **What is the law?**

A number of Pacific Island countries have signed the International Convention for the Prevention of Pollution from Ships – MARPOL 73/78. This Convention lays down three basic rules:

- |  |   |
|--|---|
| <ul style="list-style-type: none"> <li>• DO NOT discharge oil or oily mixtures into the sea.</li> <li>• DO NOT throw plastic products into the sea.</li> <li>• DO NOT throw garbage overboard within 12 nautical miles of the nearest land or reef.</li> </ul> | <p>As responsible members of the international community, Pacific Island countries support these international laws, and some are now implementing national legislation based on these pollution regulations.</p> |
|--|---|

## B. BYCATCH FROM TUNA LONGLINING

The incidental take or interaction with protected or unwanted species by tuna longline vessels has become a major issue in some countries. This issue needs to be recognised and addressed by all tuna longline fishermen.

### What is bycatch?

Horizontal tuna longlining targets specific species (Chapter 1 C), although non-target species (Chapter 1 D) are also caught at the same time. Non-target species are either:

- **bycatch**, or unwanted catch (discards) that is returned to the sea because it has little or no commercial value (includes protected species); or
- **byproduct** which, like target species, has a value and is kept and landed. In many countries it is an important part of the overall catch.

### What are the problems?

**Declining sea turtle stocks:** Sea turtle populations are declining worldwide due to human activities including: destruction or disturbance of nesting beaches; hunting for food and sale; and incidental catches related to some fishing activities such as trawling, gillnetting, purse seining and tuna longlining.

**Perceived overfishing:** There is worldwide concern about the catch and use of pelagic sharks and, to a lesser extent, marlins and other pelagic fish species by longline vessels. Some concerns are related to a belief that these species are being overfished, although current scientific evidence does not indicate this is true in the western and central Pacific.

**Seabird interactions:** The incidental take of seabirds by longline vessels (both pelagic and demersal or bottom-set) has been widely publicised, although this mainly occurs with albatross in higher latitudes.

**Not working together towards practical solutions:** In some parts of the world there is an active movement to close down pelagic longline fisheries because of concerns regarding sea turtles and other bycatch. In many parts of the region, fishermen, governments and scientists are not working together to identify the extent of the problem and develop and apply workable solutions to reduce bycatch.

### Why should tuna longline fishermen care?

The western and central Pacific Ocean supports the largest and healthiest tuna stocks in the world. Pacific Islanders can increase their participation in tuna fisheries by using sustainable and responsible pelagic longline fishing practices.

Fishermen and nations have an international and moral obligation to look after the resources they harvest, including all byproduct and bycatch. It is especially important to minimise the incidental catch and/or death of protected species such as turtles.

Higher catch rates of target species and reduced bycatch and bait loss can be achieved by altering fishing practices such as changing fishing depth or setting gear at night. It is in the interest of fishermen to avoid bycatch so there are more hooks available for target species.

Bycatch issues should be seriously addressed before restrictions and possible closures are imposed on fisheries.

Self-regulation and the cooperative development of solutions by governments, researchers and fishermen is a better approach to solving the bycatch issue than the drastic measures that may be taken.

### What can tuna longline fishermen do?

- Follow the advice in this section and seek other ways to minimise the incidental catch of unwanted bycatch species.

- Keep good data in logbooks on all fishing activities, including the recording of byproduct and bycatch taken or interactions with protected species.
- If a sea turtle is caught, follow the handling techniques in Chapter 6 C to maximise its chance of survival.
- Cooperate with observer programmes and the observer on board your vessel, as he is there to record catch data including numbers of target, byproduct, bycatch and protected species for scientific analysis.

### How to reduce bycatch

Setting pelagic longline gear deeper than 100 m will reduce the incidental catch of many bycatch species (especially sea turtles). Setting deep, using a line setter, puts the bait in the zone where catches of albacore and bigeye (target species) will be maximised.

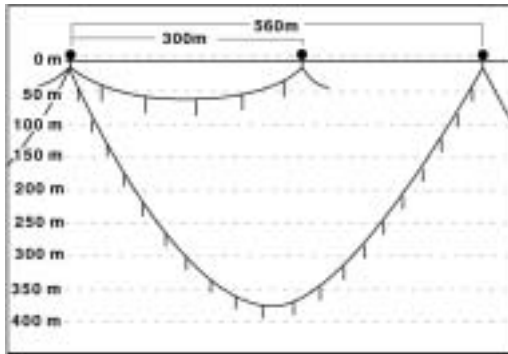

Deep set vs shallow set

Not using squid for bait on shallow-set hooks (those closest to the float and floatline) will lessen the chance of hooking sea turtles, as this is a favourite food of theirs.

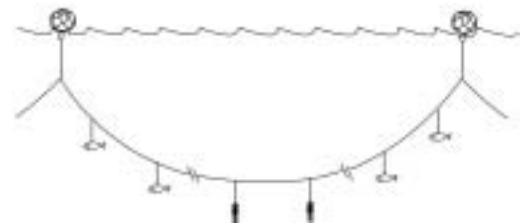

Not using a branchline under the float to target sharks.

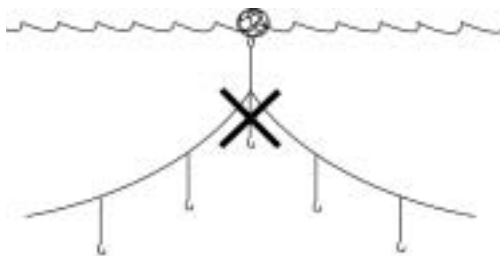

Setting pelagic longlines at least 12 nm from a reef or island, and ensuring they drift offshore, will minimise interactions with reef sharks (not pelagic sharks) and some turtle species, as they do not venture far from the reef.

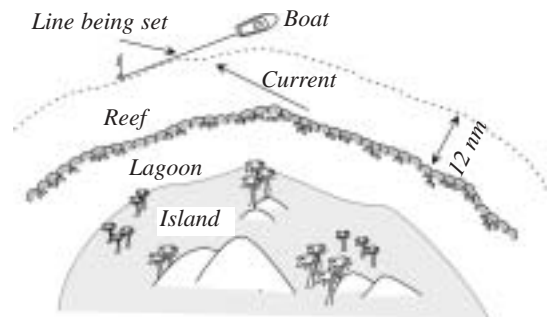

Using monofilament leaders (not wire) directly onto the hook will allow sharks to bite off the hook and escape.



The incidental catch of seabirds is not an issue in the western and central Pacific region (with the exception of Hawaii) because albatross and other large seabird species are not found in the region. Longline hooks are generally too large for the smaller seabird species in the region to swallow. Chapter 6 D covers the issue of interactions with seabirds, especially bait loss from bird attacks.





## C. RELEASING HOOKED TURTLES ALIVE

The bycatch of sea turtles by pelagic longlining is an issue of great concern. If a turtle is caught, the following steps should be taken to give it the best possible chance of survival:

**1.** Assess the turtle's size, then release it or bring in on board. If the turtle is too large to bring on board, bring it as close to the boat as possible without putting too much strain on the line, then cut the line as close to the turtle as practical.

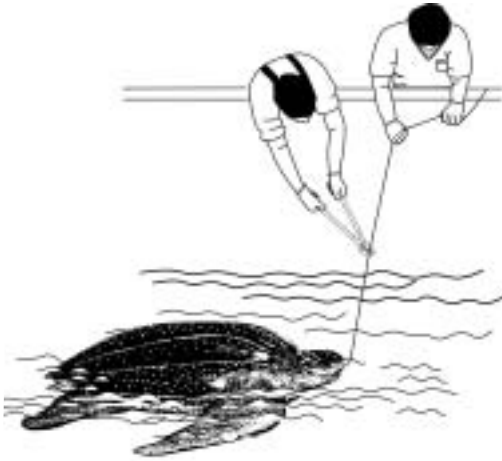

If the turtle is small, use a dip net to lift the animal on board. **DO NOT** use a gaff and **DO NOT** pull on the line or grasp the eye sockets to bring the animal on board.



**2.** Place a piece of wood in the turtle's mouth so it cannot bite, then cut the hook or line.

If the hook's barb is visible, use bolt cutters to cut the hook in half, and remove the two parts separately.



If the hook is not visible, remove as much line as possible without pulling too hard on the line, and cut it as close to the turtle as practical.

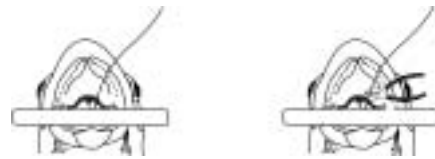

**3.** Assess the condition of the turtle before releasing it: depending on how lively it is, keep it on board for a minimum of 4 hours, and up to 24 hours.

If the turtle is sluggish or not active when lifted on board, it may have water in its lungs. In this case the rear flippers should be raised and kept about 20 cm off the deck while it is recovering.



In all cases, place the turtle in a secure shaded location of the boat. Cover the turtle's body with wet towels. **DO NOT** spray the turtle in the face with water or cover the animal's nostrils with the towel.



**4.** Carefully return the turtle to the sea

Gently put the turtle to the sea head first, while the vessel is **STOPPED** and the engine is **OUT OF GEAR**. Ensure the turtle is clear from the vessel before motoring off.



**5.** Record the interaction in your logbook, identifying the turtle species if possible, and record tag numbers if the turtle has tags on its flippers.



## D. AVOIDING SEABIRDS AND BAIT LOSS

The issue of tuna longline gear interacting with seabirds, causing incidental takes, is not an issue in the region, as stated in Chapter 6 B. There is a problem though at times with bait loss through seabirds attacking baited hooks as they are set.

In areas where seabird interactions have occurred, mitigation measures have been developed and introduced. These measures also work to reduce bait loss, by making it difficult for the seabirds to get to the baited hooks, or getting the baited hooks to sink faster.

### Night setting

Setting tuna longline gear at night is by far the simplest and easiest way to avoid bait loss to seabirds, as most seabirds are day feeders. However, in some fisheries the setting time is dictated by the main feeding time of the target species, and night setting of the gear may result in lower catch rates.

### Thawing bait fully before use

It is important that bait is fully thawed before the setting operation commences. Thawed bait sinks faster than frozen bait. This is important when seabirds are in the area. It is also easier to put the hook into a thawed bait, as often a frozen bait will break or a large hole is made when trying to force a hook through it.



### Use of a bird pole and line

A bird pole and line is probably the simplest method to scare seabirds away from the stern of the boat and the baited hooks, when setting tuna longline gear. It is simply a line around 3 mm diameter and 150 m long attached to a pole, towed off the stern with 3 to 5 pairs of streamers attached. The attachment point for the line to the pole should be as high as practical, therefore the length of the pole is determined by this. The streamers are also made of 3 mm cord, and can be covered with tubing of 5 mm inside diameter. The streamers are attached to the line by three-way swivels, and their lengths vary such that they are just clear of the water (varying lengths depending on their position along the bird line). Wave action and wind will cause the streamers to flick and whip around erratically. The baited hooks are thrown under the bird line to maximise protection from foraging seabirds.

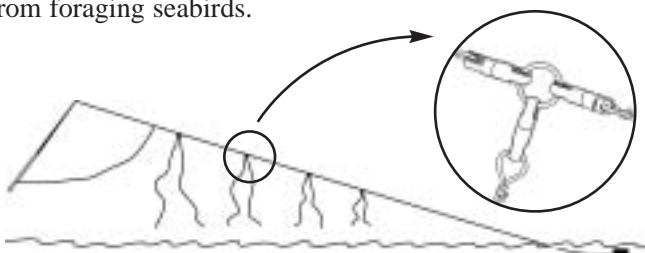

### Baits with air or swim bladders

Some bait species have swim bladders. Also, some bait may have air trapped in the gut area. When air is present in bait, it tends to float until it is pulled under by the weight of the gear. Fully thawed bait will have less chance of having trapped air.

### Using weighted branchlines

If seabirds are a problem, then using leaded swivels on the branchlines is a good solution, because it helps to sink the bait faster. However, leaded swivels are not cheap, so this adds to the cost of the gear being used.



### Using dyed baits

Some fishermen are using dyed baits to make them less visible to seabirds. Blue is the usual colour used, as it blends in with the ocean colour.

### Bait casting machines

A bait casting machine has been developed to cast baited hooks clear of propeller turbulence. This allows the baited hook to sink unrestricted by water turbulence that may keep the bait on or close to the surface. The white-water created by the vessel's wake also serves to hide the bait. The bait caster is best used in association with a bird pole and line, with the baits cast under the line for added protection.

**Note:** Do not discard offal or anything to attract feeding seabirds to the boat during line setting.

## E. DEPREDATION BY TOOTHED WHALES

‘Depredation’ is the term used when unwanted species such as cetaceans or sharks consume hooked fish, while predation refers to one species preying on another.

Toothed whales sometimes attack and eat tuna and swordfish that are caught on longlines. When a pod of these whales finds a longline with fish, they follow the line eating everything except the head of the hooked fish.

Some dolphin species have been associated with the loss of bait from longline gear. Some whales have interacted with the longline gear itself and become caught, putting the whale at risk and damaging the gear.

The incidence of depredation has been increasing in recent years, and this could be attributed to:

- increased tuna longlining effort;
- increased rates of reporting interactions;
- increases in cetacean numbers and their distribution;
- increased competition and spatial overlap with fisheries;
- past incorrect assessment of whale damage as shark damage; and
- cetaceans learning new behaviours and realising there is ‘free’ or trapped food available.

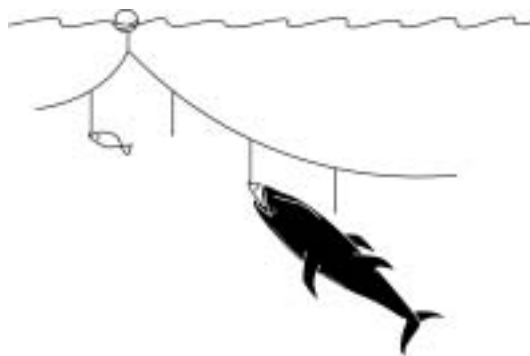

There are no known mitigation measures that are 100 per cent effective. Experiments have been conducted with acoustics to try to identify sounds that might repel some whale species. One of the unknowns is the actual effect of acoustics — will it attract or repel the whales and which whales will it affect?

Given there are no foolproof mitigation measures available at present, fishermen can make use of the following measures to avoid or minimise the chance of interactions or depredation.

- Reduce vessel noise, possibly through vessel design.
- Manage gear noise through its operation (turn off echo sounders when not in use, reduce noise of deck machinery, propeller noise etc.).
- Consider changes to gear and setting and hauling practices.
- Consider changing fishing areas and fishing seasons.
- Avoid areas where cetaceans are known to congregate.
- Keep a lookout for signs of cetaceans in the area being worked.
- Try to identify the species of cetaceans in an area to know which ones may be the problem.
- If cetaceans are sighted during the set, discontinue the set, haul the line, and move to another location.
- Use acoustic equipment to try to locate and subsequently avoid cetaceans.
- Avoid discarding offal and used bait in the vicinity of fishing locations.
- Communicate with other fishermen and pass on information on sightings, interactions and depredation.
- Document and pass on to others your experiences with mitigation measures, whether they have been successful or not.
- Carry observers to assist with species identification and recording of data.

The extent of the depredation problem is not fully known, and scientists, managers and fishermen need more information. Therefore it is very important that all fishermen document in their logbook, all cetacean sightings, interactions, and the number of fish heads left on the line, so that the magnitude of the problem can be better measured and understood.



## F. RECORDING CATCH AND EFFORT DATA

Accurate catch and effort data are essential for scientists, managers and fishermen to understand, conserve and manage the tuna and other pelagic fish stocks in the region.

### Why collect data?

The Pacific Ocean is vast and the number of tuna it contains immense. In fact, the western and central Pacific presently supports the largest tuna fishery in the world. During the 1990s, each year an average of 1.5 million mt of tuna were taken from the Pacific Ocean. Apparently we can catch a lot of tuna without endangering the stock. But how much is a lot? Could we take more? Should we be taking less? These are the questions that fishery scientists and managers endeavour to answer.

The actual number of tuna in the ocean is always changing. Fish are constantly being captured. Tuna spawn almost daily near the equator. Some factors that affect the tuna stocks are: the number of vessels fishing, how many fish they catch, the number of fish produced by spawning, and the number lost through natural mortality. Fishery scientists predict how much tuna is in the Pacific Ocean by analysing data from many different sources. Fishermen are directly involved in this work through the provision of catch and effort data.

### Regional data collection forms

To ensure that data are accurate and comparable, standardised data sheets are used for the tuna fishery of the WCPO. These include: logsheets, unloading forms, port sampling and observer data forms. The format and content of these forms are reviewed at the end of every second year (in December), by the Data Collection Committee and revised when required. The committee is made up of staff from SPC, the Forum Fisheries Agency (FFA), and other invited representatives. The year of revision is printed at the top left-hand corner of each data sheet.

### Logsheets data

Logsheets record the vessel's fishing activity, the catch (by species), and other information including: the start of the operation, gear details and the fishing position. Logsheets are used by scientists in stock assessment analyses. They are valuable because they state exactly where and when the catch was taken. This information is not available from other data, such as port sampling or unloading data. Observer data do tell the scientists when and where the catch was taken, but the number of trips covered by observers is currently low, while logsheet data are generally available for most trips.

Logsheets are also useful for fishermen. They can look back at their records and see where and when good catches were made, and this can assist them in selecting good fishing grounds based on previous catches.



### Completing logsheets

Pacific Island fishermen are requested to complete the South Pacific Regional Longline Logsheets. A copy of this sheet and the instructions for completing this form are at Appendix F.

Fishermen are requested to complete these logsheets accurately, as only accurate data will provide a valid indication of how the tuna stocks are doing. The logsheet should be filled in at the end of each set, or at the very latest, completed at the end of the trip. It should cover all the sets undertaken during the most recent trip.

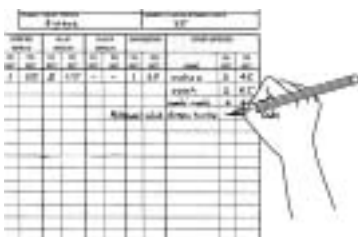

When filling in the logsheet, it is important to fill in all relevant data for each set. This should include byproduct, bycatch and protected species. You should note in the 'others' column if a protected species has been discarded or returned to the sea alive.

A new regional tuna longline logbook is currently being developed for the region. There will be one page for each day of fishing effort, so that all catch and effort data can be recorded in detail easily.

## G. RECORDING AND REPORTING TAGGED SPECIES

Every once in a while, a tagged fish comes along. Fish and other marine animals are tagged so scientists can understand both their movement and their growth. SPC's last big tagging programme may be over, but many of the tags are still out in the ocean. As well as SPC tags, there are tags from many other organisations covering a wide range of different species.

Many of the larger tagging programmes use the traditional small plastic dart tag and reward the finder with caps, T-shirts, or small sums of money. Some gamefishing and sportfishing associations promote tag and release of pelagic species. These are generally voluntary programmes and may have no reward for returned tags. The dart tag is usually located on the top of the fish behind the dorsal fin.

More sophisticated 'archival-type' tags are also being used. Archival tags collect data at regular intervals over time (depth, temperature and position) and store it on a computer chip.

The original archival tags were stitched inside the body of the fish, with a long trailing 'tail' or sensor left outside the fish, making them easy to spot. The fish has to be recaptured to retrieve the tag, and the data downloaded onto a computer. Because of the investment involved, rewards for archival tag are much larger than the rewards for dart tags.

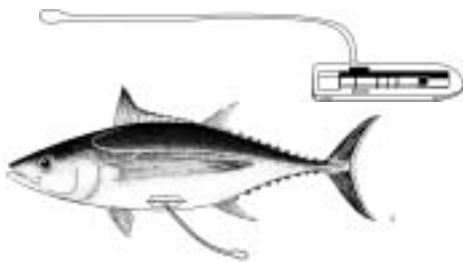

The Pacific also has a major turtle tagging programme running. Turtles are tagged on the flippers with a numbered metal tag. People returning these tags are rewarded with a cap or T-shirt.

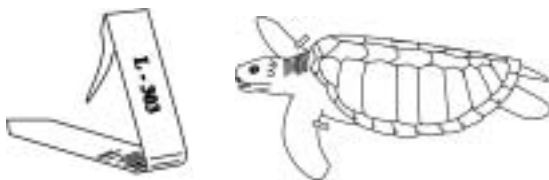

### Tag details that need to be reported

Please record and forward the following information to SPC or your fisheries department:

- the tag, stickytaped to a piece of paper, or the tag number if the animal was released;
- date of capture;
- area or location of capture;
- name of the vessel;
- gear type used;
- species captured with a tag;
- length and weight (an estimation is OK) of the captured species; and
- your name and address so that the reward can be sent to you.

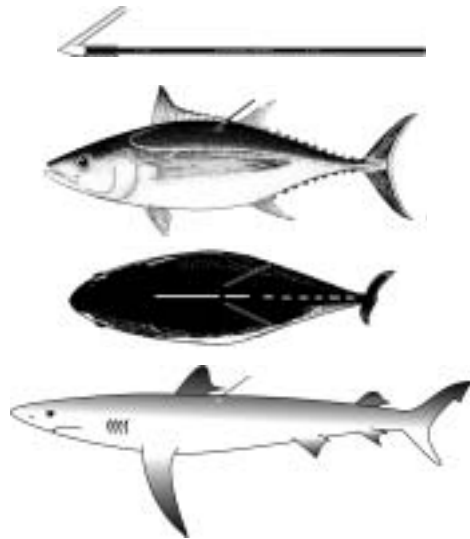

Pop-up tags are attached to the outside of the body of the fish. They are programmed to detach from the body at a predetermined time or depth and float to the surface. Once on the surface, pop-up tags transmit their information via satellite to scientists where the information is downloaded onto computer for analysis.

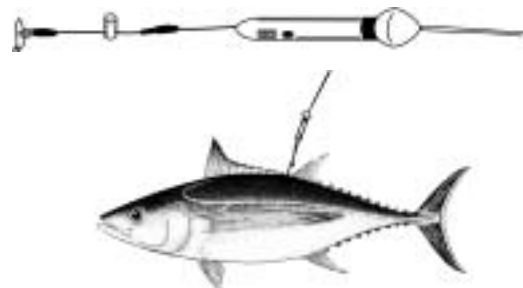

### What should a fisherman do if a tag is found?

If you catch a tagged fish or marine animal, it is imperative that you return the tag and relevant information to SPC, the organisation listed on the tag, or your local fisheries department. The information gained from tag returns is vital to the scientific analysis conducted on these species.

## H. OBSERVERS AND PORT SAMPLERS

Three other very important methods of collecting data are used to supplement the logbooks that fishermen complete. These are observer, unloading and port sampling data. The people who collect these data are trying to work with and assist tuna longline fishermen — they are NOT the ‘opposition’ or ‘enemy’. If everyone works together then each gets his work completed quickly and efficiently.

### Observers and their data

Observer data are the best monitoring data. However, observer coverage is time consuming and relatively expensive to collect. Therefore, only a small percentage of fishing trips are monitored. To help observers do the best job possible, they need the assistance and cooperation of the crew. Some of the recording or tasks an observer may undertake include:

- where, when and how much fish were caught, including byproduct and bycatch;
- fishing effort and position of fishing activities;
- length measurements of the catch;
- retention of biological samples or specimens of unusual fish;
- interactions with unwanted or protected species;
- photograph and record specifications on fish, gear, fishing operations, charts and records; and
- position and activities of other vessels sighted, to help control illegal or unlicensed activity.

### Obligations of the vessel operator

Different countries have different requirements for vessel operators when it comes to observers on tuna longline vessels. Each operator should check what the requirements are in his country. In general, vessel operators are obliged to cooperate with the observer and provide the following:

- adequate sleeping quarters and all meals while at sea, and for a nominal day or two in port;
- space for the observer’s equipment, supplies and samples;
- advice on where all sea safety equipment is stored, how it is used, and vessel safety procedures;
- access to the vessel’s log and other records including logbooks;
- information and assistance on the use of vessel electronics including navigation equipment that shows the vessel’s position;
- access to the vessel’s bridge and communication equipment, and the use of this equipment for transmitting information from the vessel to a shore base;
- access to the line setting area, work deck, fish holds and processing areas at all times; and
- when requested, permission for samples to be collected, information to be recorded and photos to be taken.

Harassment of an observer should be avoided at all costs, as this is a criminal offence in most countries.

### Unloading data

Unloading data are collected by the company agent. The number of fish by species being unloaded from a catcher vessel to a carrier vessel, a cannery or other receivers is recorded. Unloading data provide the estimated total unloaded weight of the catch by species from a vessel trip.

### Port sampling

Port samplers measure the catch at either the point of unloading or during the processing and packaging of the catch, whichever is the most convenient. Port sampling of the landed catch from tuna longliners gathers the length, and possibly weight, of each fish being measured. Length and species composition data are fundamental to the stock assessment work conducted by scientists.

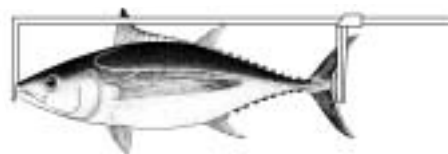

Again, a little cooperation will make the port sampler’s task easier, so that everyone gets his needs met and the quality of the fish is maintained.

Note: All logbook, observer, unloading and port sampling data are confidential; they remain the property of the national government. They are only released with approval into the public domain in an aggregated form (usually 5 x 5 degree squares).

## CONCLUDING REMARKS

Horizontal longlining is the main tuna fishing method that holds potential for economic development in many Pacific Island countries and territories. The method targets the larger, deeper swimming tunas that command high prices in export markets if they are handled carefully and quality is maintained throughout the catching, processing and exporting processes. The costs for local operators to set up a longlining operation are high, but the potential returns are also great.

SPC is actively promoting tuna longlining as a means of helping Pacific Islanders draw greater benefits from the region's large tuna resource, improve the quality of food available to the population and, where possible, divert fishing pressure away from reef and lagoon stocks that are often overfished. In promoting horizontal tuna longlining, SPC is focusing on sustainable and responsible fishing by Pacific Islanders. It is up to all fishermen to be good stewards of the resources they harvest or interact with.

We hope this manual has been useful to any readers who are inclined to try horizontal longlining. For further information, advice, or technical assistance, contact your local fisheries department, or write directly to SPC at the address below.

Secretariat of the Pacific Community  
Coastal Fisheries Programme — Fisheries Development Section  
BP D5  
98848 Noumea Cedex  
New Caledonia

Phone: + 687 26 20 00  
Fax: + 687 26 38 18  
Email: [fishdev@spc.int](mailto:fishdev@spc.int)  
Website: <http://www.spc.int/coastfish>

# APPENDICES

- A. *Weather conditions and sea state*
- B. *Important radio frequencies and the phonetic alphabet*
- C. *Glossary of nautical terms*
- D. *Main species caught on a horizontal longline in the Pacific*
- E. *Sample pre-departure checklist*
- F. *South Pacific Regional Longline Logsheet and instructions*



### Weather conditions and sea state

#### Beaufort wind scale

Wind force	Speed in knots	Description
0	less than 1	calm
1	1 to 3	light air
2	4 to 6	light breeze
3	7 to 10	gentle breeze
4	11 to 16	moderate breeze
5	17 to 21	fresh breeze
6	22 to 27	strong breeze
7	28 to 33	near gale
8	34 to 40	gale
9	41 to 47	strong gale
10	48 to 55	storm
11	56 to 63	violent storm
12	64 and over	hurricane

When wind changes clockwise it is said to veer.

When wind changes anticlockwise it is said to back.

#### Sea state code

Code figure	Description	Mean maximum height of wave in metres (and feet)
0	calm (glassy)	0
1	calm (rippled)	0 to 0.3 (0 to 1)
2	smooth (wavelets)	0.3 to 0.6 (1 to 2)
3	slight	0.6 to 1.2 (2 to 4)
4	moderate	1.2 to 2.4 (4 to 8)
5	rough	2.4 to 4.0 (8 to 13)
6	very rough	4.0 to 6.1 (13 to 20)
7	high	6.1 to 9.2 (20 to 30)
8	very high	9.2 to 13.8 (30 to 45)
9	phenomenal (might exist in centre of hurricane)	over 13.8 (45)

### Important radio frequencies and the phonetic alphabet

#### Radio frequencies

SSB radiotelephone in kHz (simplex)	VHF in mHz
<b>1. Distress, urgency, safety and calling frequencies</b>	
2182	156.800 (channel 16)
4125	
6215	
8291	
12290	
16420	
<b>2. On-the-scene search and rescue (SAR) frequencies</b>	
2182	156.800 (channel 16)
3023 (aeronautical)	156.300 (channel 6)
4125	
5680 (aeronautical)	
<b>3. Ship-to-ship navigation safety</b>	
	156.650 (channel 13)
<b>4. General ship-to-ship communication frequencies</b>	
2638	156.875 (channel 77)
4146	
4149	
6224	
6230	
8297	
12353	
12356	
16528	
16531	
22159	

Other frequencies can be found in the *Manual for Use by Maritime Mobile and Maritime Mobile-Satellite Services*, published by ITU.

**Phonetic alphabet**

<b>Letter</b>	<b>Code</b>	<b>Letter</b>	<b>Code</b>	<b>Number</b>	<b>Code</b>
A	Alfa	N	November	0	Nada-zero
B	Bravo	O	Oscar	1	Una-one
C	Charlie	P	Papa	2	Bisso-two
D	Delta	Q	Quebec	3	Terra-three
E	Echo	R	Romeo	4	Karte-four
F	Foxtrot	S	Sierra	5	Panta-five
G	Golf	T	Tango	6	Soksi-six
H	Hotel	U	Uniform	7	Sette-seven
I	India	V	Victor	8	Okto-eight
J	Juliet	W	Whiskey	9	Nove-niner
K	Kilo	X	X-ray	Decimal	Decimal
L	Lima	Y	Yankee	Full stop	Stop
M	Mike	Z	Zulu		

### Glossary of nautical terms

abaft	behind
abeam	at right angles to the fore and aft line of a vessel, 090° relative
ahead	in front of a vessel, 000° relative
aloft	up a mast or a funnel
amidships	toward the middle of a vessel
astern	towards the stern, 180° relative
athwartships	across a vessel, or side-to-side
beam	the measured width of a vessel
bearing	horizontal direction measured from 000° to 360° going clockwise; also a mechanical part
bilge	the space below the chine in the engine room or cargo hold
bilge keel	a stabiliser running fore and aft usually on the chine
bitt	mooring post on a vessel
block	an apparatus used for changing the direction of a moving line and for lifting — a block consists of a shell, a sheave (grooved pulley), a pin, and a shackle
block and tackle	two blocks and a line used to raise and lower a boom or to lift cargo — a block and tackle gives a mechanical advantage
bollard	mooring post on a wharf
boom	a pivoting horizontal spar on a mast used for lifting cargo
bow	the forward-most part of a vessel
bulkhead	the wall or partition that separates compartments of a vessel
bulwarks	the built-up part of the railing surrounding a vessel at deck level
bunkers	fuel space; also refuelling
cap rail	the reinforced top part of the bulwarks — often just called the rail
capstan	a mechanically powered spindle sometimes called a cathead that is used for pulling lines such as anchor lines or mooring lines
catenary	the natural sag in a line, sometimes called the catenary curve
chine	that part of the hull where the side and bottom plates meet
chock	an open or closed line guide
cleat	a cattle-horn-shaped bitt for securing mooring lines or lifting lines
coaming	a raised opening to a hold that prevents water entering the hold — usually about 50 or 60 cm above the deck
cofferdam	an empty compartment between fish hold and bunker space or fish hold and engine room
collision bulkhead	a secure, watertight bulkhead separating the bow and stem from the fo’c’sle or forepeak
compass bearing	direction in relation to north on the compass, either true or magnetic
compass point	11.25 degrees (11¼°) — there are 32 points on the compass
cutlass bearing	a tubular brass and rubber or nylon bearing that supports the main shaft where it exits the hull
davit	a small crane used for lifting
dead ahead	000° relative to the vessel
dead astern	180° relative to the vessel
deck	the floor plates of a vessel
depth	the measured distance from the main deck to the keel of a vessel
dog	a levered handle used to secure a hatch
downhill	travelling in a following sea
draft	the measured distance from the waterline to the keel of a vessel
fairlead	a chock with rollers for guiding a line

fid	a conical pin or spike used in splicing rope
fix	to determine a vessel's position using compass, charts, radar, land features and vessel electronics
flake	to lay a line down for storage — sometimes called fake
flopper-stopper	usually paired vanes that hang from outriggers and reduce the roll of a vessel that is underway — also called stabilisers
flush hatch	a hatch with no coaming
flybridge	outside station on the roof of the wheelhouse
fo'c'sle (or forecastle)	the bow compartment just aft of the collision bulkhead, when it is used for crew's quarters
following sea	when the sea is on the stern, the vessel is going downhill
fore and aft	lengthwise on a vessel
forepeak	forward most compartment on a vessel, just aft of the collision bulkhead
forward	toward the bow
freeboard	the part of the vessel between the water line and the continuous deck level
funnel	air duct for cooling exhaust stacks or compartments
galley	the kitchen
hatch	the opening to a hold
hatch cover	a removable cover that seals the hatch
hawser	a large diameter line used for mooring, anchoring, or towing
helm	the steering-wheel or tiller of a vessel, the main control station
hip	aft of the bow but forward of the beam of a vessel — there is a starboard hip and a port hip
hold	a space for storing cargo or fish, accessible by a hatch
hull	the outside structure (shell) of the vessel
keel	the fore and aft backbone of a vessel, where the bottom plates come together
keel cooler	looped through-hull pipes mounted between the keel and the chine that use seawater to cool engine cooling water, hydraulic oil or refrigerant
ladder	the steps going from one deck to another or into a hold
lazarette	the rudder room
let go	to drop the anchor
list	fall over to one side
lee side	side away from the wind
length over all (LOA)	the measured length of a vessel from stem to stern
length on the waterline (LWL)	the measured length of a vessel at the waterline
make fast	to secure a line to a bitt or bollard
mast	vertical post that supports booms, outriggers, antennae and other rigging
open block	a block that is open on one side of the shell to receive the bight of a line
outside station	a remote helm, usually on deck or on a flybridge
pintle bearing	a tubular bearing on the shoe plate that supports the rudder post
pitch	up-and-down movement of the bow and stern of the vessel
port	left side facing forward
position	vessel's latitude and longitude
quarter	the part of the hull that is aft of midships but forward of the stern — there is a port quarter and a starboard quarter
quarter the sea	heading at a 45° angle into the sea, especially in rough weather
range	distance — usually given in nautical miles (nm)
relative bearing	direction relative to a vessel, where dead ahead is bearing at 000°
roll	side-to-side movement of a vessel, usually when it's in the trough
rub rail	a reinforcing rail usually running fore and aft between the chine and the deck on the outside of the hull

rudder	a moveable vane just aft of the propeller that steers the vessel
rudder post	the shaft of the rudder that extends from the lazarette to the shoe plate
rudder post housing	a vertical tube in the lazarette with a stuffing box and bearing
rules of the road	International Regulations for Preventing Collisions at Sea
scupper	a freeing port (opening) usually cut into the bulwarks
scuttle	entrance to the engine room from the deck
set and drift	the direction and velocity of the current
shackle	a 'U' shaped link with a removable pin used for joining chains or other apparatus. A shackle of anchor chain is equal to 27.5 m (15 fa) of chain — with the lengths joined by a shackle
sheave	grooved pulley or roller portion of a block that takes the bight of a line
shoe plate	an extension of the skeg that supports the rudder post and holds the pintle bearing
shroud	wire support on a mast or rigging running athwartships
single screw	vessel with one main engine and one propeller
skeg	an extension of the keel that houses the propeller shaft and extends under the propeller
skipper	the captain
snatch block	a block that can be opened and closed to receive the bight of a line
spring line	a mooring line used to pull or spring a vessel into or away from a wharf using the vessel's forward or reverse motion
stabiliser	flopper-stopper or bilge keel or other device to reduce the roll of a vessel
stack	dry exhaust pipe
stanchion	upright post or support
starboard	right side facing forward
stay	wire support on mast or rigging running fore and aft
stem	the forward-most line of the bow
stern	the after-most part of a boat
stuffing box	the shaft gland
take a turn	run a line around a bitt or bollard
through-hull	any fitting that penetrates the hull
transom	the after-most portion of the shell of the hull
trough	that portion of the sea lying between the waves; to be 'in the trough' means that the sea is abeam
twin screw	vessel with two main engines and two propellers
underway	any vessel that is not anchored, aground, or tied to a wharf or pier; a vessel drifting is underway with no way on
uphill	travelling going into the sea
vessel	boat
waterline	sea-level line on the outside of a vessel, changes with load
watertight	a bulkhead or hatch that will not let water in when sealed
weigh	to raise the anchor
wheelhouse	the superstructure where the vessel is operated from, contains the helm and compass, and all navigational aids — also called the bridge
windward side	side the wind is on
yaw	when the stern of a moving vessel tries to overtake the bow as in a following sea
zinc	sacrificial anode that prevents hull, shaft, and engine parts from rusting

Main species caught on a horizontal longline in the Pacific

English	French	Japanese	Scientific
albacore tuna	germon, thon blanc	tombo, binnaga maguro	<i>Thunnus alalunga</i>
bigeye tuna	thon obèse	mebachi maguro, shibi	<i>Thunnus obesus</i>
big-scaled pomfret	castagnole fauchoir, brème noire	hirejiro-manzai-uo	<i>Taractichthys longipinnis</i>
black marlin	makaire noir	shiro kajiki	<i>Makaira indica</i>
Indo-Pacific blue marlin	makaire bleu de l'Indo-Pacifique	kuro kajiki	<i>Makaira mazara</i>
blue shark	peau bleue	yoshikiri zame	<i>Prionance glauca</i>
escolar	escolier noir	bara mutsu	<i>Lepidocybium flavobrunneum</i>
great barracuda	barracuda	onika masu	<i>Sphyræna barracuda</i>
mahi mahi, dolphin fish	coryphène commune	shiira	<i>Coryphaena hippurus</i>
oceanic whitetip shark	requin océanique	yogore	<i>Carcharhinus longimanus</i>
opah, moonfish	opa, lampris	akamanbo, mandai	<i>Lampris guttatus</i>
Pacific bluefin tuna	thon rouge du Pacifique	kuro maguro	<i>Thunnus orientalis</i>
sailfish	voilier de l'Indo-Pacifique	basho kajiki	<i>Istiophorus platypterus</i>
shortbill spearfish	makaire à rostre court	furai kajiki	<i>Tetrapterus angustirostris</i>
short-finned mako shark	taupe bleu	ao zame	<i>Isurus oxyrinchus</i>
silky shark	requin soyeux	kurotogari zame	<i>Carcharhinus falciformis</i>
skipjack tuna	bonite à ventre rayé	katsuo	<i>Katsuwonus pelamis</i>
snake mackerel	escolier serpent	kurotachi kamasu	<i>Gempylus serpens</i>
southern bluefin tuna	thon rouge du sud	minami maguro	<i>Thunnus maccoyii</i>
striped marlin	marlin rayé	ma kajiki, nairaigi	<i>Tetrapterus audax</i>
swordfish	espadon	me kajiki, shutome	<i>Xiphias gladius</i>
thresher shark	requin renard	onaga zame	<i>Alopias</i> spp.
tiger shark	requin tigre commun	itachi zame	<i>Galeocerdo cuvier</i>
wahoo	thazard-bâtard	kamasu sawara	<i>Acanthocybium solandri</i>
yellowfin tuna	albacore, thon jaune	kihada maguro, shibi	<i>Thunnus albacares</i>

**Sample pre-departure checklist**

Vessel: Name:			Departure: Date:		
Engine hours before departure:			Trip number:		
			Signed	Checked	Action taken
Fuel					
Engine oil (# of litres)					
Fresh water (# of litres)					
Spare oil filters	Yes	No			
Spare fuel filters	Yes	No			
Spare alternator belt	Yes	No			
Spare cooling pump belt	Yes	No			
Engine oil level checked	Yes	No			
Gear oil level checked	Yes	No			
Battery water level checked	Yes	No			
Cooling water level checked	Yes	No			
Bilge water level					
Bilge pump working	Yes	No			
Life raft on board	Yes	No			
Life ring on board	Yes	No			
No. of smoke flares					
No. of red flares					
Medical kit					
No. of parachute flares					
EPIRB tested	Yes	No			
Compass light working	Yes	No			
Torch checked and working	Yes	No			
Spare torch battery on board	Yes	No			
VHF working	Yes	No			
SSB working	Yes	No			
Navigation lights working	Yes	No			
Echo sounder/GPS working	Yes	No			
Fire extinguisher full	Yes	No			
Any electrical problems	Yes	No			
Any electronic problems	Yes	No			
Any engine problems	Yes	No			
Captain: Crew: Crew:			Crew: Crew: Crew:		

I certify that the above information is true to the best of my knowledge and that the vessel is equipped according to company guidelines and ready for departure.

Signed: .....

CAPTAIN

ENGINEER





## South Pacific Regional Longline Logsheet instructions

### Block One: Vessel Identification and Trip Information

Country of Registration and Registration Number in Country of Registration: Print the name of the country in which the vessel is registered (e.g. “Japan”) and the registration number issued by the country in which the vessel is registered (e.g. “ME1-808”).

FFA Regional Register Number: Print the number issued by the Forum Fisheries Agency for inclusion of the vessel on the FFA Regional Register (e.g. “12345”).

FFA Type Approved ALC (Y/N) ?: Print “Y” if the vessel has an FFA Type Approved Automatic Location Communicator (ALC) on-board. Print “N” if the vessel does not have an FFA Type Approved ALC onboard.

Fishing Permit or Licence Number(s): If the vessel fished under one or more bilateral access agreements, then print the fishing permit number issued by each of the coastal states in whose waters the vessel fished during the trip. If the vessel fished under a multilateral treaty, then print the fishing permit number issued to the vessel under the multilateral treaty. If the vessel is registered in the coastal state, then print the fishing licence number issued by the coastal state.

Name of Agent in Port of Unloading: Print the name of the agency or agencies which represented the vessel in the port or ports in which the vessel unloaded the catch recorded on the logsheet.

Year: Print the year in which the vessel departed from port at the start of the trip.

Hooks between Floats: Print the number of hooks used between successive two floats.

Primary Target species: Print the primary target species for this trip.

### Block Two: Catches

Complete at least one line of Block Two for each set that was made during the trip. If no sets were made during the day, then provide the Month, Day, Activity Code, and the 01:00 UTC Position. If necessary, use more than one line to record the catch of other species.

Month and Day: The day should correspond to the day on which the crew started the set.

Activity Code: Use Activity Code 1 (‘A set’) if the line in Block Two corresponds to a set of the longline gear in the water. Use Activity Code 2 (‘A day at sea but not fished or transit’) if the vessel was at sea, but the longline gear was not placed in the water that day and the vessel was not in transit. Use Activity Code 3 (‘Transit’) if no sets were made and the vessel spent most of the day in transit. Use Activity Code 4 (‘In port - please specify’) if no sets were made and the vessel spent most of the day in port. If no code exists, please describe the activity on the form.

01:00 UTC or Set Position: If a set was made, print the position of the start of the set. If no sets were made during the day, print the position at 01:00 UTC. The position should be recorded to the nearest minute of latitude and longitude (e.g. “08–22 N” and “165–45 E”).

Set Start Time: Print the UTC time when the crew started placing the longline gear in the water.

Number of Hooks: Print the total number of hooks that were set.

Albacore, Bigeye and Yellowfin: Print number of fish caught and retained under *NO RET*. Print the total amount of the whole weights for albacore, and the gilled-and-gutted weights for bigeye and yellowfin, of all fish that were caught and retained, in kilogrammes, under *KG RET*. Print number of fish that were discarded under *NO DISC*.

Shark: Print the number of fish caught and retained, **excluding** fish from which only the fins were retained and not the body, under *NO RET*. Print the number of fish discarded, **including** fish from which only the fins were retained and not the body, under *NO DISC*.

Striped Marlin, Blue Marlin, Black Marlin, and Swordfish: Print number of fish caught and retained under *NO RET*. Print total amount of the processed weights of all fish that were caught and retained, in kilogrammes, under *KG RET*.

Other Species: Print the full name of the species under *NAME*. Print the number of fish caught and retained under *NO RET*. Print the total amount of the processed weights of all fish that were caught and retained, in kilogrammes, under *KG RET*. When more than one ‘other’ species occurs in a set, use additional lines on the logsheet.

Vessels Sighted: If other fishing vessels are sighted, write the name of the vessel, and other identifiers, such as the vessel type, on one line of the logsheet.

Whale Predation: If any fish were predated by whales, write the number of fish predated by whales on one line of the logsheet.