



**SECRETARIAT OF THE PACIFIC COMMUNITY
FISH AGGREGATING DEVICE (FAD) MANUAL**

VOLUME III

DEPLOYING AND MAINTAINING FAD SYSTEMS



SECRETARIAT OF THE PACIFIC COMMUNITY FISH AGGREGATING DEVICE (FAD) MANUAL

VOLUME III DEPLOYING AND MAINTAINING FAD SYSTEMS

BY

PAUL D. GATES, GARRY L. PRESTON & LINDSAY B. CHAPMAN



GOVERNMENT OF TAIWAN/ ROC

**COASTAL FISHERIES PROGRAMME
CAPTURE SECTION**



**SECRETARIAT OF THE PACIFIC COMMUNITY
NOUMEA, NEW CALEDONIA**

© Secretariat of the Pacific Community, 1998

The Secretariat of the Pacific Community authorises the reproduction of this material, whole or in part, provided appropriate acknowledgment is given.

Original edition: English

‘Pacific Community’ is the new name of the South Pacific Commission (SPC). The new name became official on 6 February 1998, in commemoration of the 51st anniversary of the 1947 Canberra Agreement which originally established the SPC.

The change of name does not alter the established SPC acronyms, but their meanings are modified.

‘Pacific Community’ applies to the total organisation, i.e. the member governments, the Conference, the CRGA and the Secretariat. **‘Secretariat of the Pacific Community (SPC)’** refers to those who provide the service to members of the Community.

Secretariat of the Pacific Community cataloguing-in-publication data

Secretariat of the Pacific Community Fish Aggregating Device (FAD) Manual/
P. Gates... [et al.]

Contents: v.i. Planning FAD programmes—v.ii. Rigging
deep-water FAD moorings—v.iii. Deploying and maintaining FAD
systems

1. Fish aggregating device—Handbooks, manuals, etc.
2. Fisheries—Equipment and supplies
- I. Secretariat of the Pacific Community Coastal Fisheries Programme Capture Section

639.2028

AACR2

ISBN 982-203-482-2 (set)

ISBN 982-203-621-3 (v.3)

Authors

1. Paul D. Gates (deceased)
2. Garry L. Preston, Gillett, Preston and Associates Inc., BP 11041, 98802 Noumea Cedex, New Caledonia
3. Lindsay B. Chapman, Fisheries Development Adviser, Secretariat of the Pacific Community, BP D5, 98848 Noumea Cedex, New Caledonia

Prepared for publication at
SPC headquarters, Noumea, New Caledonia
and printed by
Stredder Print, New Zealand

ACKNOWLEDGMENTS

Preparation of this manual benefited from the inputs of several current and former SPC Fisheries Programme staff, including Peter Watt, Steve Beverly, Paul Mead, Paxton Wellington, Peter Cusack, Aymeric Desurmont, Marie-Ange Roberts, Satalaka Petaia and Julian Dashwood. The authors are grateful for their contributions. Preparation of this volume was kindly funded by a grant from the Government of Taiwan/ ROC.

UNITS, CONVERSIONS AND ABBREVIATIONS

Metric units are used throughout this document except in the case of distance at sea, where nautical miles (nm), the standard international measure, are used. A nautical mile is equivalent to one minute (one-sixtieth of a degree) of latitude. Technically the standard nautical mile is 6,080 feet (1,852 m).

Conversions between metric and imperial units are as follows:

1 millimetre (1 mm)	=	0.039 inch	1 inch	=	25.38 mm
1 centimetre (1 cm)	=	0.393 inch	1 inch	=	2.54 cm
1 metre (1 m)	=	3.281 feet	1 foot	=	0.305 m
1 metre (1 m)	=	0.546 fathoms	1 fathom	=	1.83 m

Some manufacturers use nominal equivalents in converting between metric and standard US measures. The nominal equivalents of the metric measures given in this document are as follows:

5 mm	=	3/16 inch	16 mm	=	5/8 inch
6 mm	=	1/4 inch	19 mm	=	3/4 inch
8 mm	=	5/16 inch	22 mm	=	7/8 inch
10 mm	=	3/8 inch	25 mm	=	1 inch
12 mm	=	1/2 inch	50 mm	=	2 inch
14 mm	=	9/16 inch	100 mm	=	4 inch

Apart from the units of measure noted above, other abbreviations used regularly in this document include the following:

dia.	Diameter
FAD	Fish Aggregating Device
SPC	Secretariat of the Pacific Community

DISCLAIMER

Reference to trade names of products or processes in this document does not constitute endorsement by any of the sponsoring agencies named above. Reference to persons in any particular gender is understood to include persons of the opposite gender unless otherwise stated, or made explicit by the context.

TABLE OF CONTENTS

INTRODUCTION	1
CHAPTER 1: SITE SURVEYS	3
A. General criteria for FAD site selection	4
B. Using marine charts	6
C. Basic procedures and requirements	8
D. Echo-sounder	10
E. Survey planning	12
F. Survey techniques using GPS	14
G. Plotting a bottom contour map	16
H. Selecting the deployment position	18
CHAPTER 2: DEPLOYMENT	21
A. FAD design characteristics	22
B. Basic deployment techniques	24
C. Factors affecting anchor placement	25
D. Calculating buoy drift	26
E. Modifications to the deployment technique	27
F. Deployment vessel and layout	28
G. Preparing FAD components	30
H. Deployment procedure	32
CHAPTER 3: INSPECTION AND MAINTENANCE	35
A. General inspection	36
B. Physical inspection	38
C. Maintenance and repair	40
D. Record keeping	42
CONCLUDING REMARKS	43

INTRODUCTION

This is the third and final volume of the series of manuals on fish aggregating devices, or FADs, produced by the Secretariat for the Pacific Community (SPC). FADs are anchored rafts that, for reasons not yet fully-explained, cause tunas and other oceanic fish species to collect together where they can be caught more easily by various kinds of fishing methods. FADs have made a major contribution to fish landings, fishing economics and the safety of fishermen in Pacific Island countries. However the relatively high cost of building and deploying the devices, as well as the high FAD loss rates experienced in many cases, have led to potentially valuable FAD programmes being cancelled or cut back. SPC research on this issue revealed that many of the problems being experienced with FADs in Pacific Island countries and territories were the result of human error or lack of understanding of the physical, engineering and economic factors affecting FAD performance. In many cases they could be addressed by improved planning, more careful design and construction techniques, more rigorous deployment procedures, and better maintenance.

SPC FAD MANUALS

This situation led to the production of the SPC series of FAD manuals, which were intended to provide Pacific Island fisheries agencies with information that could help them improve their FAD programmes. The first volume in the series dealt with planning of FAD programmes, and looked in detail at the costs and benefits of FADs and ways of assessing and monitoring these. The second volume covered FAD design and fabrication, focusing on two particular models recommended by SPC because of their low cost, ease of construction and long expected life span. Both volumes are available free of charge to fisheries workers in the Pacific Islands region, and at a small cost to those outside the region. They can be obtained by writing to SPC at the address given on the last page of this manual.



This final volume in the series describes how to survey potential FAD sites, how to deploy a FAD, and how to carry out follow-up maintenance in such a way as to minimise the risk of loss or damage and to maximise the FAD's life-span. The manual is divided into three main sections:

- a description of site survey techniques needed to locate a suitable deployment location;
- the actual deployment procedure, including information on how to properly prepare a FAD for deployment (a stage which is frequently neglected);
- post-deployment inspection and maintenance.

The present manual provides enough information to allow the reader to correctly prepare for and carry out a FAD deployment. If possible, however, the reader should try to obtain copies of the first two volumes since they contain a good deal of additional valuable material which is not repeated here.

CHAPTER 1

SITE SURVEYS

- A. GENERAL CRITERIA FOR FAD SITE SELECTION**
- B. USING MARINE CHARTS**
- C. BASIC PROCEDURES AND REQUIREMENTS**
- D. ECHO-SOUNDER**
- E. SURVEY PLANNING**
- F. SURVEY TECHNIQUES USING GPS**
- G. PLOTTING A BOTTOM CONTOUR MAP**
- H. SELECTING THE DEPLOYMENT POSITION**

INTRODUCTION

This chapter describes the procedures to be followed in selecting potential FAD sites and then carrying out detailed surveys of depth and bottom topography. The chapter also covers the plotting of bottom contour maps based on survey data, and the interpretation of these maps to identify suitable FAD sites.

SECTION 1A: GENERAL CRITERIA FOR FAD SITE SELECTION

Assuming that a decision has been made to set up a FAD programme, the next logical step is a process of site selection by which the specific locations for the FADs are chosen.

The first step in the process is that of deciding the general area where the FADs will be placed. This generally takes place at a political or strategic level and may be influenced by factors such as the development priorities and alternatives in various parts of the country, availability of funding, access to markets, numbers of fishermen in the area, and the economic benefits the FAD programme is expected to generate. All these issues are discussed in more depth in the SPC FAD Manual Volume I, which is entitled ‘Planning of FAD Programmes’.

At the next level down, once a general area has been selected for FAD deployment, more technical and local considerations come into play in the site selection process. These include such factors as:

- historical presence of tuna;
- topography of the seabed;
- depth;
- prevailing weather and sea conditions;
- recommended FAD spacing; and
- accessibility.

Volume I of the SPC FAD Manual discusses these issues in detail, but they are summarised here in the following paragraphs.

Historical presence of tuna

Whenever possible, FADs should be placed in areas where tuna and other pelagic species are historically known to occur. Local fishermen are likely to know when and where fish occur in abundance, and should be consulted. Even fishermen who don’t specifically target tuna may be a good source of information. For instance those who target bottom fish often troll for skipjack tuna to use as fresh bait. Most fishermen will be able to report areas where tuna schools are frequently sighted.

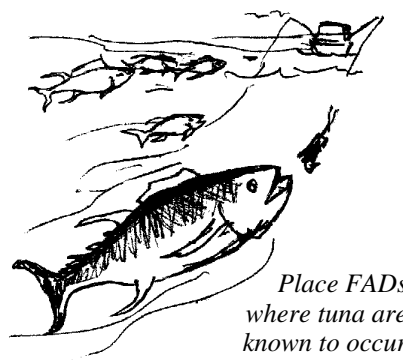

Topography of the seabed

The best FAD mooring sites are broad flat areas with little or no slope. Broad areas are important because, for reasons described in section 2C, the anchor’s actual path of descent during deployment is somewhat unpredictable. As a result the anchor may end up several hundred metres away from the intended landing spot. Narrow flat areas, sharp slopes, and steep drop-offs, all increase the potential for the anchor to end up in the wrong depth. This could lead to mooring damage or stress and premature failures.

The best mooring sites are broad flat or gently sloping areas

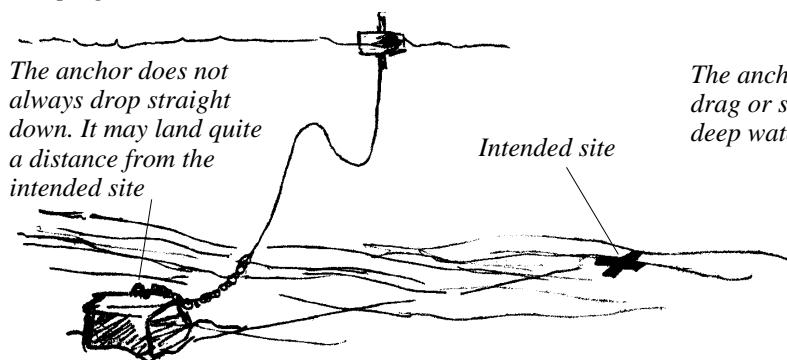

Steep slopes and narrow zones are poor mooring sites

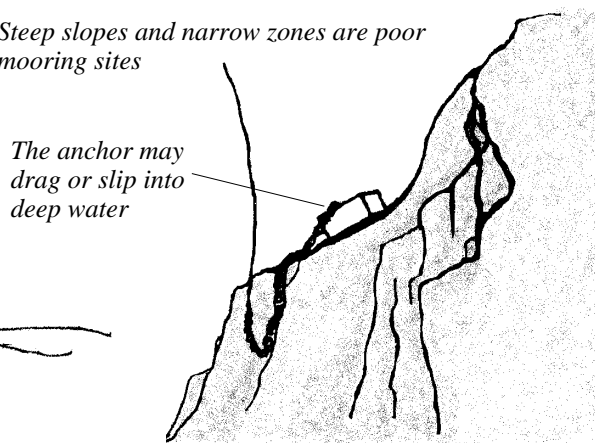

A flat or gently sloping sea floor will also help prevent the anchor from being dragged into deep water when rough weather exerts tension on the mooring. Bottom areas with steep ridges, pinnacles, or crevices should be avoided, as they could all lead to premature mooring failure, for instance through rope abrasion on rocks or ridges. The FAD could become lost on deployment, the anchor could be dragged into deep water, or the mooring may not function in accordance with its design.

Depth

FADs moored shallower than 500 m generally do not aggregate tuna effectively. In addition, FAD mooring costs increase with depth because of the greater length of mooring rope needed. FADs moored in 1,000–2,000 m generally work well, and mooring costs are lower than for those deployed in deeper waters. Under some circumstances, however, it may be necessary to deploy FADs in much greater depths.

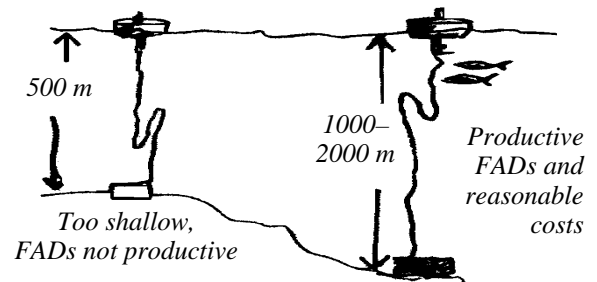

Avoid areas where currents are always strong...

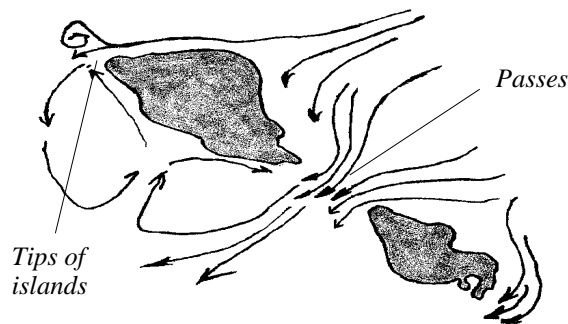

Prevailing weather and sea conditions

Care should be taken to avoid sites where bad weather and rough sea conditions prevail, since this will limit the amount of time fishermen can work around the FADs. Under such circumstances the investment in FADs is likely to be high compared to the benefits realised.

Sites where strong currents exist should also be avoided. Like bad weather and rough seas, strong currents increase the strain on the mooring, causing mooring components to wear more quickly. High current areas often occur at the ends of islands, and in passes between islands.

Recommended FAD spacing

In general FADs aggregate most effectively when moored 4–5 nm from seaward reefs or the 75 m (40 fathom) contour, and when spaced 10–12 nm apart. That distance and spacing minimises interference from either reefs or other FADs.

Of course there are always exceptions to rules like this. Some FADs moored closer to shore have succeeded in aggregating fish effectively. In addition, in some areas the bottom drops so steeply that it's impossible to moor FADs 4 or 5 nm offshore because the water is too deep. However when choosing a new site that has never been previously tested it is best to observe the recommended spacing whenever possible.

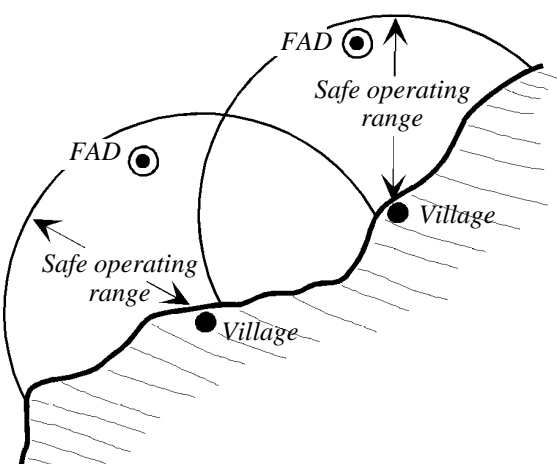
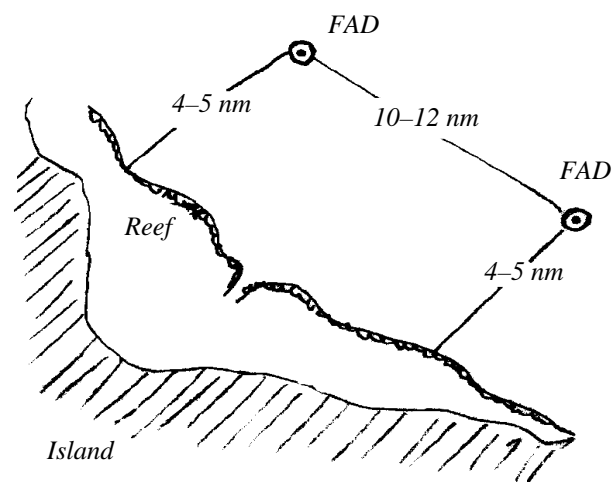

Accessibility and safety

FAD sites should be selected to be safely accessible to the local fleet. Site location and distance from shore depends on the seaworthiness and safe operating range of local fishing vessels. Fishermen's familiarity and experience in the offshore environment is also a factor. FADs beyond the normal operating range of the fleet or the comfort range of fishermen may not see much use. Normally FADs improve the safety of offshore fishermen by concentrating fishing activities in a known area. However if fishermen are used to operating in inshore waters, then encouraging them to fish further offshore may introduce dangers for which they are not prepared.

Sites determined on the basis of these criteria offer the greatest potential for realising the benefits of FADs, achieving FAD programme goals, and attaining the longest possible FAD life spans.

SECTION 1B: USING MARINE CHARTS

Navigational charts are an obvious tool which can be used to select preliminary FAD mooring sites. They are available for almost all areas of the world, and provide valuable basic information on depth, bottom type, shipping patterns and other marine features. Other useful references also exist, including the *Pacific Seafloor Atlas* by Brian Taylor et al.

However map-reading and interpretation are not necessarily natural or intuitive skills; marine charts follow a number of conventions and carry numerous specialised symbols which are not obvious and have to be learned. The diagram below shows just a few of the symbols that may be found on nautical charts.

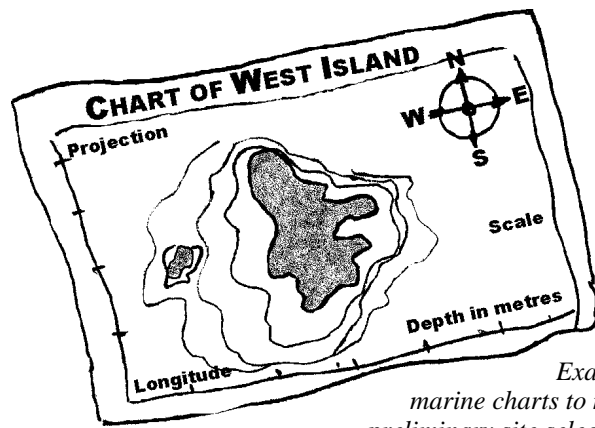

Examine marine charts to make preliminary site selections

Q. Soundings

1	SD	Doubtful sounding
2	ES	No bottom found
3		Out of position
4		Least depth in narrow channel
5	30 FEET APR 1958	Dredged channel (with controlling depth indicated)
6	24 FEET MAY 1958	Dredged area
7		Swept channel (See Q-9)
8		Drying or uncovering height in feet above chart (sounding) datum
9		Swept area, not adequately sounded (shown by green tint)
9a		Swept area adequately sounded (swept by wire drag to depth indicated)
10		Hair-line depths
10a	8 ₁ 19	Figures for ordinary soundings
11	8 ₁ 19	Soundings taken from foreign charts
12	8 ₂ 19	Soundings taken from older surveys or smaller scale charts
13	8 ₁ 19	Soundings taken by echo
14	8 ₂ 19	Sloping figures (See Q-12)
15	8 ₂ 19	Upright figures (See Q-10a)
16	(25)	Bracketed figures (See Q-1, 2)
17	<u>8</u>	Underlined sounding figures (See Q-8)
18	3 ₂ 6 ₁	Soundings expressed in fathoms and feet
(Qc)		Stream

R. Depth Contours and Tints (see General Remarks)

Feet	Fathoms	Feet	Fathoms
0	0	300	50
6	1	600	100
12	2	1,200	200
18	3	1,800	300
24	4	2,400	400
30	5	3,000	500
36	6	6,000	1,000
60	10	12,000	2,000
120	20	18,000	3,000
180	30		
240	40		

S. Quality of the Bottom

1	Ground	25	Mt	Mussels	50	spk	Speckled	
2	S	Sand	26	Spq	Sponge	51	gry	Gritty
3	M	Mud; Muddy	27		Kelp	52		Decayed
4	Oz	Ooze	28	Wd	Seaweed	53	fly	Flinty
5	Ml	Marl	29	Grs	Grass	54	glac	Glacial
6	Cl	Clay	30		Seaweed	55		Tenacious
7	G	Gravel	31		Spiculate	56	mb	White
8	Sn	Shingle	32	Fr	Foraminifera	57	bk	Black
9	P	Pebbles	33	Gl	Globigerina	58	vr	Violet
10	St	Stones	34	Di	Diatoms	59	bu	Blue
11	Rk, rky	Rock; Rocky	35	Rd	Radiolaria	60	gn	Green
11a	Bls	Boulders	36	Pt	Pteropods	61	yl	Yellow
12	Ck	Chalk	37	Pb	Polyzoa	62	or	Orange
12a	Ce	Calcareous	38		Cirripede	63	rd	Red
13	Qz	Quartz	39		Fucus	64	br	Brown
14	Co	Coral	40	fine	Mattes	65	ch	Chocolate
14 (Se)	Co Hd	Coral head	41	crs	Fine	66	gr	Gray
15	Mts	Madrepores	42	eft	Coarse	67	lt	Light
16	Vol	Volcanic	43	stf	Soft	68	dk	Dark
17	Vol Ash	Volcanic ash	44	hrd	Hard	70		Varied
18	Lv	Lava	45	stf	Stiff	71		Uneven
19	Pm	Pumice	46	smf	Small			
20	Tuf	Tufa	47	lrg	Large			
21	Sc	Scoriae	48	stk	Sticky			
22	Cnd	Cinders	49	brk	Broken			
23	Mng	Manganese		grd	Ground			
24	Shls	Shells			Rotten			
25	Oysters	Oysters			Streeky			
76								Fresh water springs in sea-bed

For this reason it is important that the people involved in FAD site selection should have a good basic knowledge of map-reading and be able to interpret marine charts. This generally means that some type of basic navigation training or experience is a prerequisite for those involved in making decisions relating to FAD placement.

Edition and scale

The edition number and publication date is given on every marine chart. The most recently published charts should be used wherever possible since these will provide the most up-to-date information. Charts that provide the largest and most detailed view of the areas under consideration should be selected. Charts with a Mercator projection scale of 1:50,000 or 1:100,000 are good, although a scale of 1:200,000 is much more common. Larger numbers indicate that the chart covers a larger area, in less detail. The chart scale is listed along the top or below the chart title.

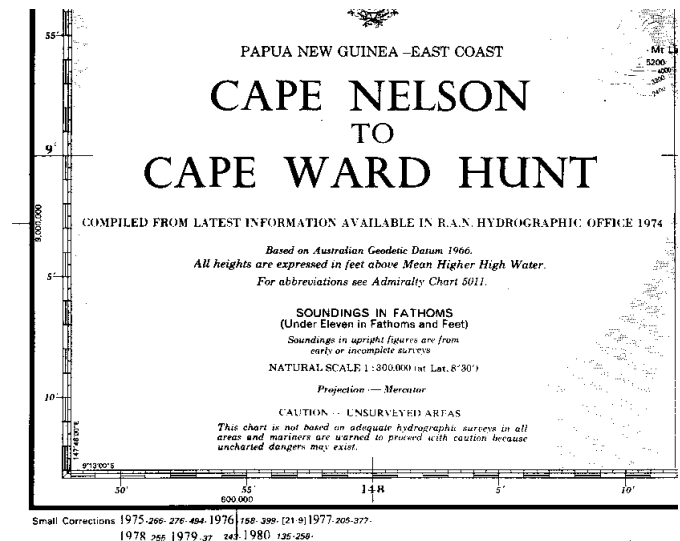

Sharp, steep slopes are unsuitable for FADs...



...look for broad flat areas

Chart reliability

Charts are useful for making preliminary site selections, but they should not be used to make the final selections of FAD sites. Even recent charts, particularly ones of relatively isolated island areas, are not completely reliable. Charts are based on sounding transects and spot soundings which may be few and far between. They may focus mainly on shallow coastal waters and may have been made a very long time ago. Consequently the chart may not be very accurate in its depiction of the bottom topography and contour of the seabed.

It is therefore necessary to always conduct a thorough and proper survey prior to deploying FADs at any new sites. Surveys provide accurate depth information and reveal the topography of the seabed in much more detail than reported on most available charts. Surveys allow deployment of FADs where the chance of seabed-associated mooring damage or premature FAD loss is lowest.

Soundings

The soundings (depth measurements) and contours on the chart should be examined for broad, flat or gently sloping areas of seabed, away from ledges or steep drop-offs, that occur at a reasonable depth. These will make the best FAD sites.

In most cases the soundings give a good indication of the general depth and slope of an area. However in some instances the charted depths for offshore areas may be inaccurate or too sparse to be really useful. In addition, many marine charts do not show contour lines in the range of depths where FADs are normally deployed. Therefore, although they may provide good preliminary information, marine charts often do not give the complete picture.

Isobaths (contour lines)...

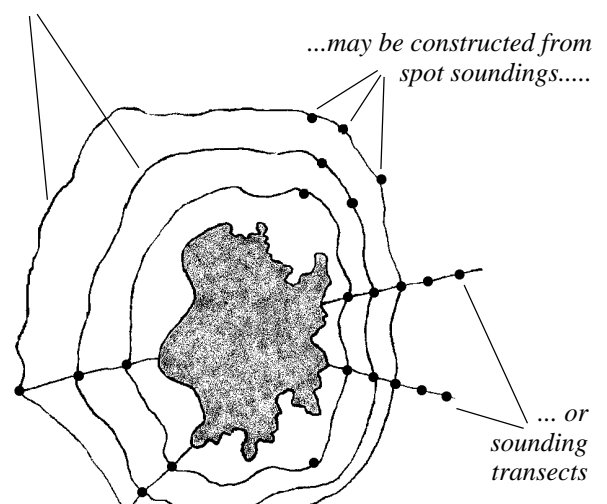

Charts are not always reliable, especially if based on few or very old sounding data

SECTION 1C: BASIC PROCEDURES AND REQUIREMENTS

The basic procedure for carrying out a site survey is for a vessel equipped with a deep-water echo-sounder to follow a series of parallel tracks, or **transects**, taking soundings as it goes. The position of each depth measurement is recorded using global positioning system (GPS) navigational equipment. The information gathered is then plotted on graph paper to produce a contour map of the sea floor, which allows the best FAD sites to be selected and unsuitable areas to be avoided. Because all positions have been accurately recorded, the FAD sites selected from the contour map can then be transferred to a marine chart.

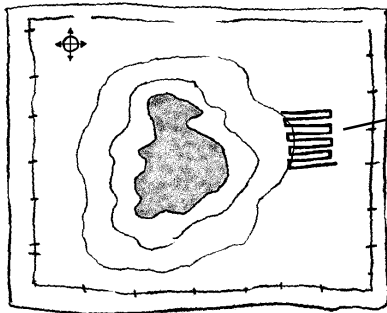

The chart is used to identify the survey area, which is then divided into transects...

... which the survey vessel then follows, measuring depth as it goes

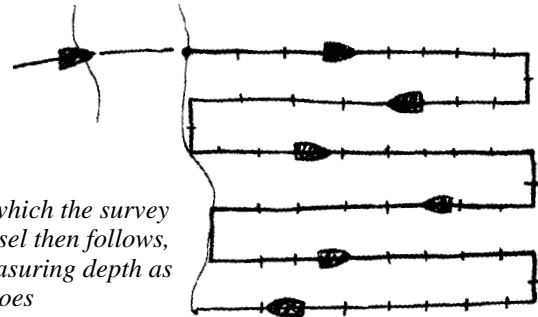

The specific site survey procedures to be used may differ somewhat depending on the operational conditions and on the preferences of the people doing the work. For instance, depths can be recorded at regular intervals, either of distance or of time. The SPC-recommended technique is to take soundings at regular distance intervals, as described in section 1F. Alternatively, depth can be tracked and the latitude and longitude of predetermined depth measurements can be recorded, as also described in section 1F. In any case the processes of transect layout and determining the survey area are common to all methods.

Survey vessel

The survey vessel need not be large or sophisticated. Even small launches can be used to carry out FAD site surveys provided they carry the right equipment and are seaworthy enough to operate under the conditions that prevail in the survey area. In many cases the survey vessel and the vessel used to deploy the FAD (see section 2F) are one and the same, but this does not have to be so.

Vessel-roll can cause problems with obtaining accurate echo-sounder readings. Wherever possible FAD site surveys should be carried out using a stable, sea-kindly vessel (which usually means a broad, beamy vessel) rather than one which is prone to rolling (typical of long, narrow boats).

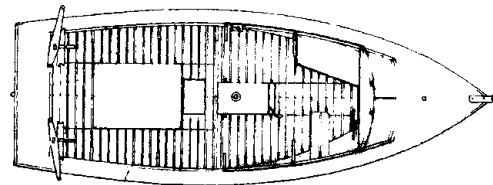

Carry out surveys using sea-kindly vessels which are not too prone to rolling



Avoid using long narrow boats which are most likely to roll

Echo-sounder with colour screen

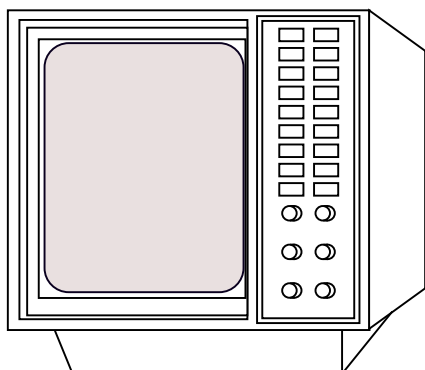

Echo-sounder

A good-quality echo-sounder is an essential survey tool. Again the unit need not be sophisticated, but it must give a clear and accurate reading of the bottom depth. All echo-sounders have a margin of error ($\pm 2-5$ per cent), and the chance of error is greatest when units are operated near or at their maximum rated depth. Most FADs are deployed between 750 and 2,000 m, and sometimes deeper, so sounders should have a rated depth of at least 2,000 m, and preferably 3,000 m or more.

The installation and operation of the echo-sounder is described in more detail in section 1D.

Navigation instruments

These are needed to determine the survey vessel's precise position at regular intervals while running the transects, and to allow the site to be relocated at a later time.

It is highly preferable to use a GPS (Global Positioning System) receiver for this purpose, because such a unit makes conducting site surveys simple and precise. The GPS receiver utilises signals transmitted simultaneously from three or more satellites to calculate position continuously, with an accuracy which can be as good as ± 20 m. A GPS receiver with a simple plotting screen continuously indicates the vessel's position with a digital readout of latitude and longitude and a graphic or track of the vessel's movements on the display screen. GPS units also provide information on course made good, speed along route, speed toward destination, and bearing and time to destination.



Various types of GPS unit

GPS units offer an especially applicable feature for site surveys. The waypoints (literally, points along the way) of a desired course can be programmed into the system. The GPS then figures the course from one waypoint to the next, signals when a point is reached, then displays the course heading and distance to the next point, and so on, until the track is complete.

GPS units are more or less essential for site surveys. The traditional alternative of taking land bearings using a compass is not really practical given the number of sightings that need to be taken during the course of a survey. In any case there is no longer any real reason for not using a GPS, since the cost of these units is now very low—in many cases cheaper than a compass. Good-quality GPS units can be purchased for well under US\$ 1,000, and the cheapest hand-held models are less than US\$ 100. Compared to the cost of constructing and deploying FADs, the investment in a GPS unit is small, and very worthwhile.

The use of the GPS in FAD site surveys is described more fully in section 1F.

Charting instruments

Graph paper, appropriate marine charts, pencil and eraser, parallel rulers and dividers are required to prepare bottom contour maps from the survey data and to transcribe some elements of it (position fixes, the size and location of the survey site, and selected FAD sites) onto the charts. A calculator is also very useful for working out the positions of depth contours when they occur between soundings.

Procedures for charting and the plotting of information gathered during the survey are discussed in more detail in section 1G.

Skilled personnel

A final, but essential, pre-requirement is a team of personnel who are capable of using all this equipment and carrying out the tasks required. A FAD site survey requires individuals who are proficient in coastal navigation, helmsmanship, the correct operation of the electronic equipment (echo-sounder and GPS) being used, and charting.

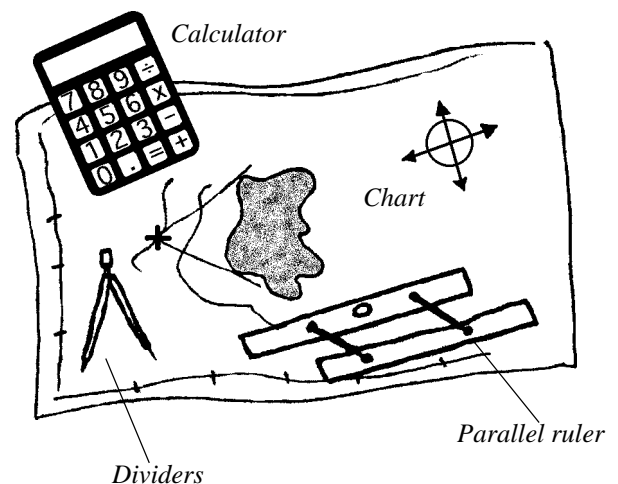

SECTION 1D: ECHO-SOUNDER

Echo sounders comprise two main components: the **display unit** and the **transducer**.

The display unit is usually mounted in the vessel's wheelhouse or other convenient location, and shows a continuous depth readout once the sounder is switched on. Older units generally displayed the depth by making a trace on a slowly scrolling roll of paper, which was convenient because the paper rolls could be kept for reference. Newer units often have a liquid-crystal display (LCD) which replaces the paper roll, or a cathode-ray tube (CRT, similar to a TV screen) with a multi-coloured display that indicates not only depth but also bottom type, water temperature and other features. Although these units have a certain amount of internal memory, which allows recent soundings to be reviewed, this is normally limited and they must generally be linked up to a videotape recorder or computer if a permanent record of the soundings is to be made.

The transducer emits and receives the echo-sounder's signal. It is fixed to the boat below the water line, and is connected to the display unit by a length of shielded cable which transmits data back and forth between the two components. The cable itself is calibrated to the sounder's data transmission needs and should never be shortened or extended. If this is done the sounder will give false readings (or none at all).

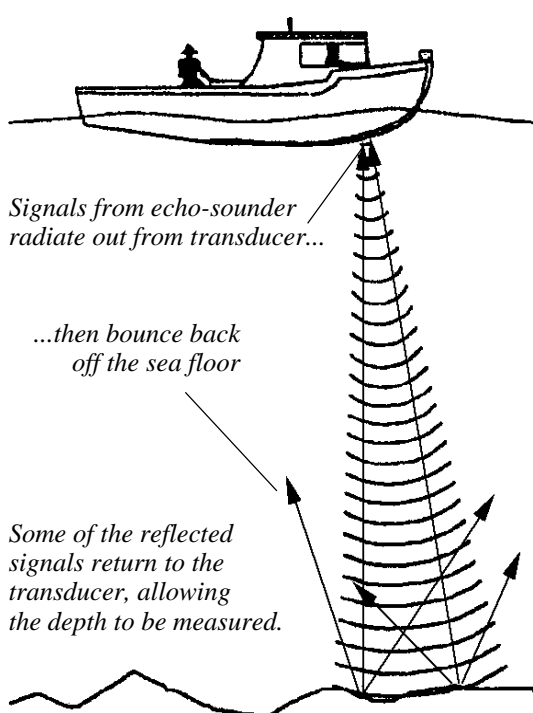

Transducers operate by emitting bursts of low-frequency sound, which is usually hardly audible to the human ear but which is conducted strongly over long distances in water. The sound is reflected from any surfaces it encounters, including the sea bottom, fish, plankton, suspended particles in the water, and even temperature discontinuities where the density of different layers of water changes. The reflected signals bounce back to the transducer which detects their strength and transmits this information to the display unit. By computing the time between transmission and bounce-back, the echo-sounder measures the distance to the source of the reflection and posts this information on the display.

A sounder's depth rating depends on both the power of the signal emitted by the transducer, and the frequency of the sound used. The more powerful the signal and the lower the frequency, the greater the depth rating. A unit that puts out a signal with 2 kilowatts (kW) of power at a frequency of either 28 or 50 kilohertz (kHz) should be able to measure depths of 1,500 m or more. For deeper soundings a 28 kHz transducer and 3 kW of output power may be needed. Some multiple-frequency echo-sounders have switchable transducers, or may use two or more transducers to maximise sound propagation in different depths or conditions.

Most sounders run on 12 or 24-volt direct current which can be delivered from the vessel's electrical power system or, on a small boat without a power system, by connecting the sounder to a couple of car batteries. Stronger transducer signals require greater power input than those with low-power transducers. A 24-volt sounder that produces a 2 kW signal will consume about 6.5 amperes per hour. A typical 12-volt car battery holds about 50 amp-hours when fully charged, but will not be reliable after its charge has dropped to about 50%. Two such batteries connected in series should therefore provide enough power to operate the sounder constantly for about 3–4 hours.

Transducer mounting

The recommended location for the transducer is one-third of the vessel's length back from the bow. When the echo-sounder is mounted on the survey vessel it is very important that the surface of the transducer should be horizontal. If the transducer is mounted at an angle the sensitivity to signals bouncing back from the sea floor will be reduced, while sensitivity to scattered signal reflections will be increased, affecting the clarity of the display. The normal rolling of the survey vessel will also change the transducer angle and contribute to reduced sensitivity, so wherever possible the transducer should be positioned to minimise the effects of vessel roll.

Permanent mounting

Through-hull mounting requires the vessel to be pulled out of the water so that a hole can be drilled through the hull and the transducer permanently set in the desired position. This is normally the best way to mount a transducer because it allows positioning away from sources of interference (other shipboard electronics, engine and propeller noise, bubbles, etc.). However once the transducer is mounted in this way, removing it or relocating to another part of the vessel, or to another vessel, becomes a major headache.

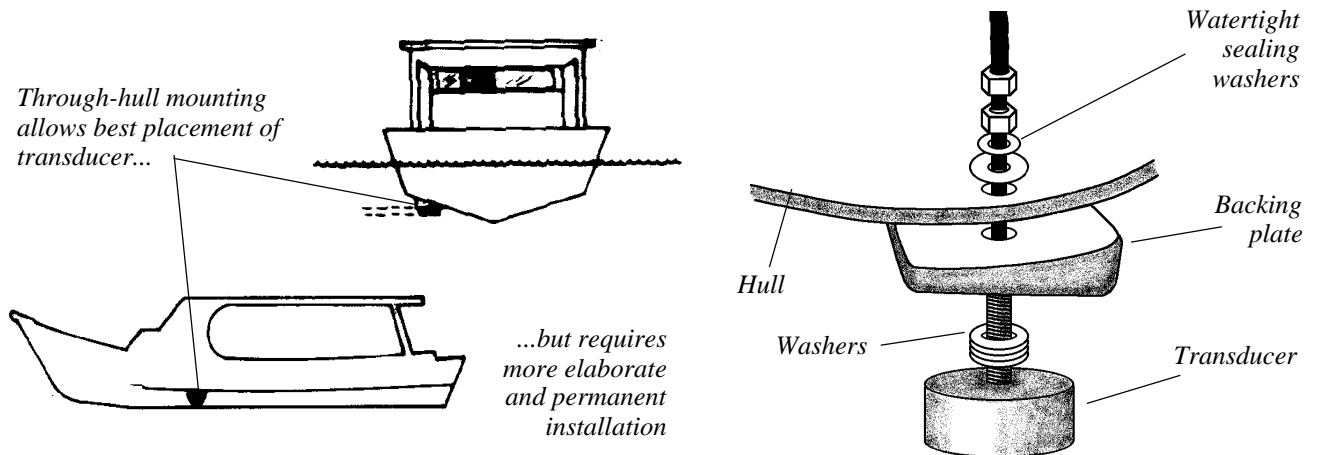

Temporary mounting

This is an option which allows the echo-sounder to be moved from boat to boat if necessary, and which avoids complicated installations, vessel haul-outs and the drilling of holes through the hull. A suitable temporary mounting involves fitting the transducer to the end of a length of aluminium or, as a second choice, steel pipe which can then be lashed to the gunwale of the survey vessel or fixed in pipe clamps attached to the vessel's sides. Numerous options are possible depending on the size and shape of the survey vessel. The main requirement is to get the transducer well below the water surface where it will not be affected by bubbles, and to ensure the transducer is mounted horizontally.

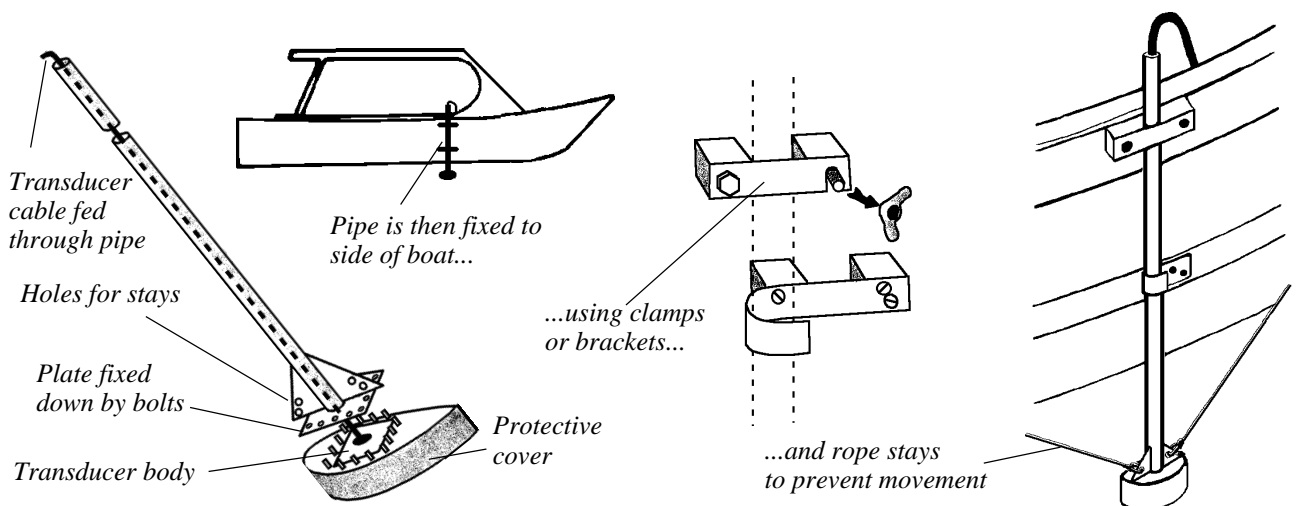

Echo-sounders are delicate instruments that require frequent adjustments in order to give clear, accurate readings. The power of the transducer signal must be adjusted as depth varies. Shallower depths require less powerful signals than deeper waters. Seabed substrate affects sounder readings so that rocky and sandy bottoms send back a strong signal and appear dark, while muddy bottoms appear light and sometimes faint. Interference from other instruments or from the vessel's engine or generator can also distort sounder recordings. Vessel-roll and strong vertical features on the sea floor may cause side-echoes or displacement of the real bottom image. The sounder operator must therefore understand all the unit's functions and adjustments and be able to interpret readings, diagnose problems quickly, and adjust the unit to maintain a clear, accurate display.

SECTION 1E: SURVEY PLANNING

Selecting the survey zone

Offshore FADs are generally not considered to be productive when set in depths of less than 500 m, so there is little point in surveying these areas. The same applies to areas which are so deep that the mooring will cost a fortune, or which are beyond the capacity of the sounder to accurately measure. The marine chart should thus be used to select an area which appears to lie between 500 m and the maximum desired depth for the FAD. As mentioned in section 1A, the ideal depth would be 1,000–2,000 m, but local topography may force deployments to be much deeper than this in some cases.

Calculating survey coverage

To calculate a survey area which represents a reasonable day’s work it is necessary to know the expected operating speed of the vessel and the spacing of the survey transects. Our recommended spacing is one quarter of a minute of latitude for the E–W transects (e.g. 10°18.000’S; 10°18.250’S; 10°18.500’S) and one quarter of a minute of longitude for the N–S transects (e.g. 167°23.250’E; 167°23.500’E; 167°23.750’E). This spacing gives sufficiently detailed depth information while also allowing reasonably rapid coverage.

A minute of **latitude** always equals a nautical mile. When close to the equator, a minute of **longitude** approximately equals one nautical mile. If the recommended spacing of 0.250’ is adopted, then the survey area can be calculated as follows. An area of 2’ x 2’ requires nine 2’ (≈ 2 nm) transects to be run. A short distance (0.4 nm) should also be counted for turning and re-positioning when one transect is finished and a new one commenced. This totals approximately 18 nm of actual transects and 3 nm for turning, or a total of about 21 nm of survey track altogether.

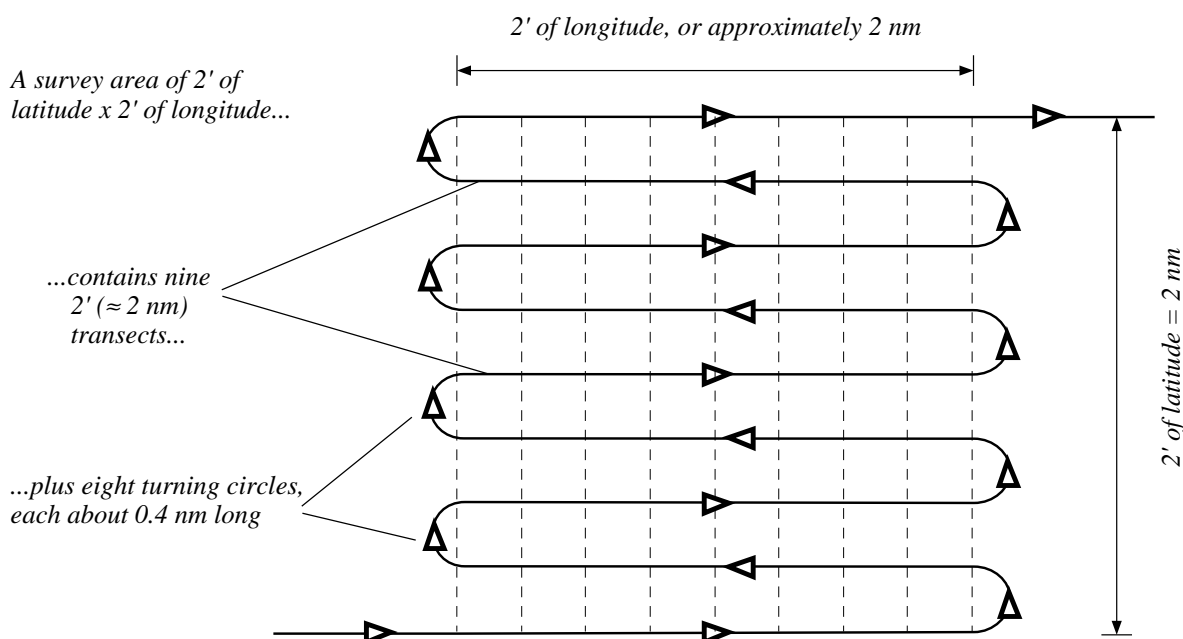

If the survey vessel operates at an average of 4 knots, then it will take about 5 hours to complete the 2' x 2' survey. To this, needs to be added the travel time to and from the survey site, any time needed for position fixing and an allowance for other lost time. It can therefore be seen that a vessel surveying at 4 knots will probably not be able to survey a lot more than a 2' x 2' area during a normal daylight operation.

Practical considerations also influence the size of the area that can be surveyed in one day. If the vessel does not have an on-board power system then enough batteries will be needed to run the sounder for as long as required. As mentioned in section 1D, two standard fully-charged automobile batteries can be expected to power a deep-water sounder in continuous use for about 3-4 hours. In any case it is always good practice to have back-up batteries on hand.

Site surveying is tedious work. A 2' x 2' survey area entails recording at least 81 positions and soundings over a 20-nm course. In addition it is always sensible to allow some time for dealing with any complications that might arise. A 2' x 2' survey area generally represents a good day’s survey work.

Laying out the transects

The general location of the survey zone can be marked on a chart to give an idea of its position relative to major coastal features in the area. In most cases however the scale of the chart will be too small to allow the individual transects to be laid out. These should thus be drawn out separately on a piece of graph paper at an appropriate scale. The positions of the transects should be marked as a series of parallel lines running in either a north–south (N–S) or an east–west (E–W) direction and stretching from the 500 m contour to the survey area’s outer boundary, which may be decided based on depth, distance offshore, or other factors. If operating in a N–S direction, one transect will head south while the next will head north on a reciprocal (opposite) heading, and the next south again. Similarly if the running direction is E–W then the transects alternate between these two headings.

The reason for selecting a N–S or E–W direction for transect lines is to simplify the plotting of the bottom contour map as described later in section 1G. The actual direction selected will depend on weather and sea conditions at the time of the survey, since it is important to choose a transect orientation which will keep vessel-roll to a minimum. If excessive vessel-roll or other operational reasons prevent the use of a N–S or E–W course then alternative courses can be run, using the same principle of alternating transects on reciprocal courses. However the subsequent production of a bottom contour map will be a bit more complicated, as explained in section 1G.

Chart scale will usually be too small for detailed marking out of transects...

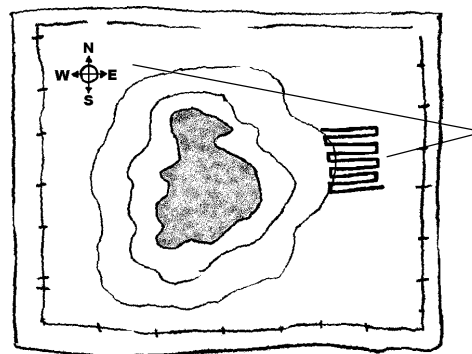

... but can be used to align them in a N–S or E–W direction, and to give a general picture of the survey area’s location.

Setting GPS waypoints

As mentioned in section 1C, a GPS unit offers the simplest and most accurate means of following transects within a survey area. Once the survey area and transect lines have been drawn on the chart then standard plotting instruments are used to determine the starting position (latitude and longitude) of the first transect. This data is entered into the GPS receiver, enabling the GPS to use it as a waypoint from which to display course headings and guide the vessel through the survey area.

GPS corrections

The position information emitted by GPS satellites is referenced to the World Geodesic System (WGS) 1984, while marine charts are often referenced to local or regional data. As a result, the position of an object given by a GPS may differ slightly from the position of the same object indicated on the chart. To accurately reference and plot site-survey information on charts, GPS positions must be corrected so that they correspond exactly to the reference datum used to prepare the chart.

Position the GPS (or the survey vessel) at a prominent landmark which is shown on the chart...

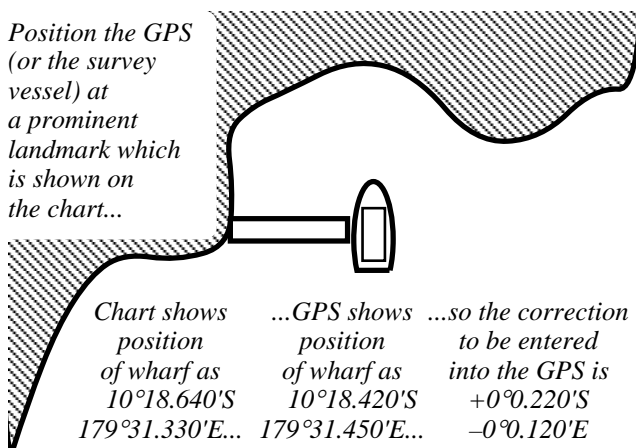

Recently published marine charts usually list GPS correction figures. These may consist of a direction (N or S for latitude, E or W for longitude) or a distance (either in seconds or thousandths of a minute), or both. If the chart does not list corrections, they are fairly simple to work out. The GPS is taken to a clearly defined, charted landmark and the latitude and longitude coordinates read off. This is then compared to the landmark’s coordinates as given by the chart. The difference between the two positions is the correction. Ideally the GPS position of the landmark should be taken a number of times over a period of a few days, so as to find the average correction value.

Corrections may vary between charts, and so should always be checked each time a new chart is used, for instance when changing survey areas. The corrections generally reflect relatively small differences in position, but are necessary for accurate GPS-navigational chart referencing. They should be entered into the GPS before any survey work commences.

SECTION 1F: SURVEY TECHNIQUES USING GPS

Standard survey method

Once transect lines have been charted and waypoint coordinates, plus any necessary corrections, entered into the GPS as described in section 1E, the actual survey can begin. When the vessel departs for the survey area the GPS will determine a course heading and direct the helmsman to the first waypoint.

The echo-sounder should be powered up and adjusted to give clear readings before the vessel reaches the starting point, where the first depth recording is made. To proceed along the first transect the helmsman then steers a N–S or E–W course as previously determined (see section 1E), following the line of the transect as closely as possible.

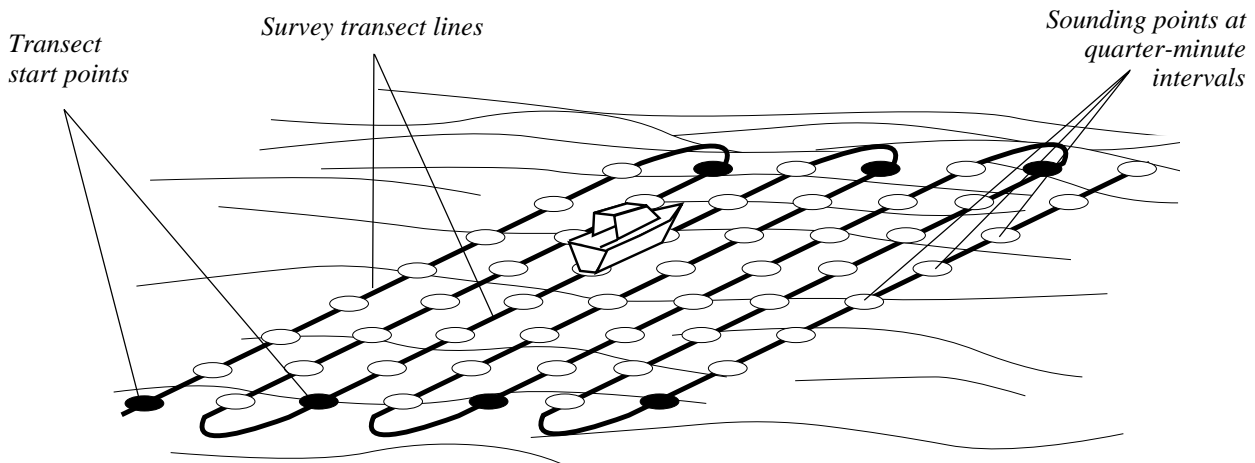

As the vessel proceeds, one person has the responsibility of watching the GPS to check the position, and calling out at intervals of one quarter-minute (of distance) that a depth-reading is needed. Each time this happens the echo-sounder operator reads off the depth to the person recording the data.

Once the required distance has been covered or the end of the transect reached, the vessel uses the GPS to navigate to the starting point of the next transect, which should be 0.250' away from the previous transect's end-point, in a direction which is perpendicular to it.

A simple logsheet, ruled horizontally and vertically to form boxes, should be used for data recording. Information to be written down includes the position (latitude and longitude) and depth of each sounding, and its number (first, second, third) along the transect.

This survey method can easily be carried out by a team of two: a helmsman who steers the vessel and calls out the position readings along the transect lines, and a technician who operates the echo-sounder and records data. In many cases however, there will be more than two people on board the survey vessel, in which case the tasks can be apportioned or rotated among three or four individuals as convenient.

Modifying the survey area

It may turn out that, after laying out the survey transects ahead of time, the marine chart used for planning is inaccurate and the depths encountered when starting the survey are greater or less than expected. In this case it may be necessary to compensate by shifting the transect positions some distance inshore or offshore.

Transect 1 (Waypoint 1 - Waypoint 2)		
Sounding	Position	Depth (m)
1	7°10.750' S 138°19.250' E	510
2	7°10.750' S 138°19.500' E	590
3	7°10.750' S 138°19.750' E	655
4	7°10.750' S 138°20.000' E	682
5	7°10.750' S 138°20.250' E	698

Organise a simple logsheet for data recording

This can be done quite simply. The survey vessel scouts the survey area until a suitable new starting point—often at the 500 metre contour—has been found using the echo-sounder. The position of the vessel is fixed using the GPS, and is used in place of the original starting position. The survey is carried out as planned, with transects being run in a N–S or E–W direction, but based on the new starting position instead of the original one.

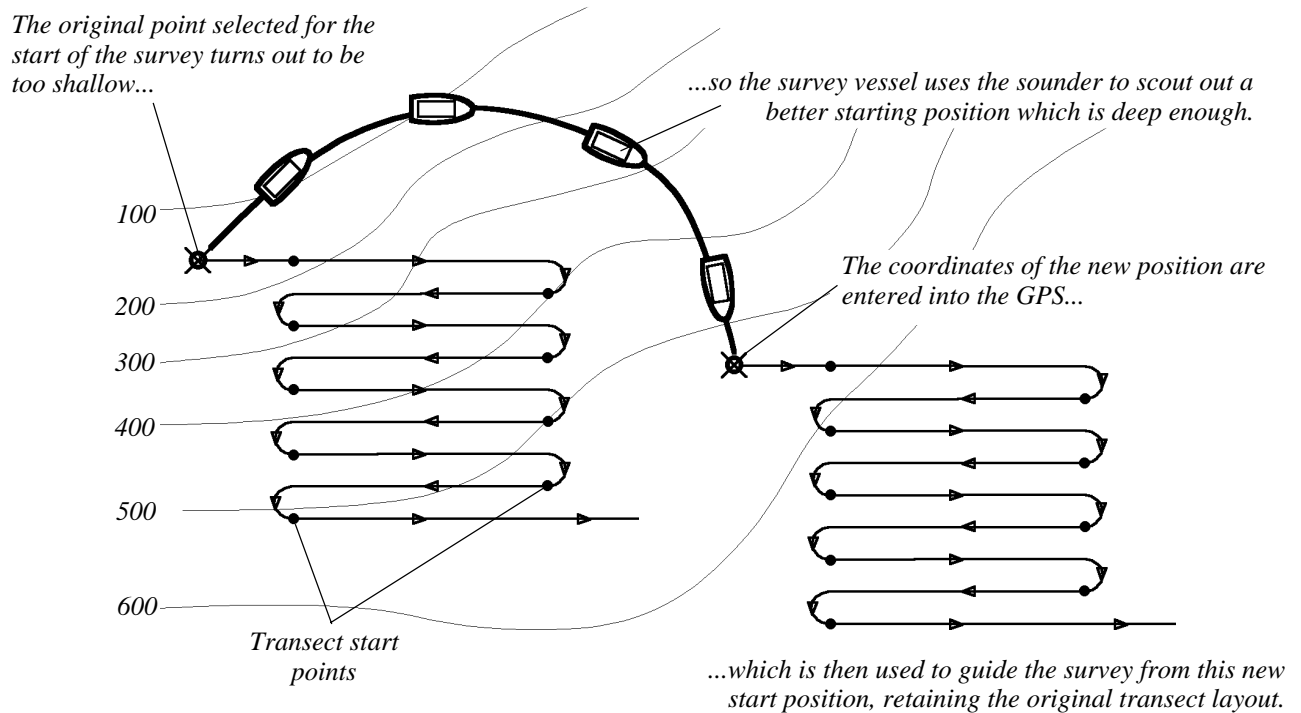

Alternative survey method

Rather than measuring the depth at a series of predetermined positions, as explained above, the converse can be done, i.e. recording the position each time a specified depth increment is reached. Using this system the survey vessel proceeds along the transect while the echo-sounder operator monitors the depth, calling out each time a depth contour—typically 100 m—is crossed. At these times the person watching the GPS reads out the latitude and longitude to the data recorder.

The main advantage of this system is in plotting the survey data afterwards, since the latitudes and longitudes of the various contour lines are measured directly rather than being estimated (see section 1G). However there is a disadvantage in that, unless the sea floor has an even slope, readings will be taken at irregular intervals rather than regular ones. In areas where the floor slopes steeply, readings will need to be taken in rapid succession, perhaps too quickly to be practical. As a rule therefore, the method of taking readings at regular intervals of distance is the recommended one.

Taking soundings every 0.250' results in regularly spaced depth measurements

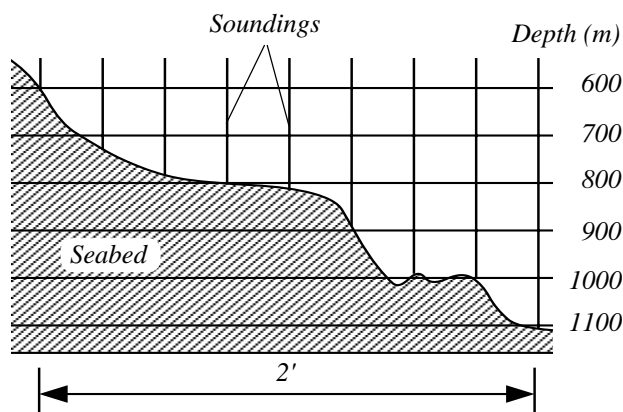

Taking soundings when contours are crossed results in soundings being packed in some areas and too widely spaced in others

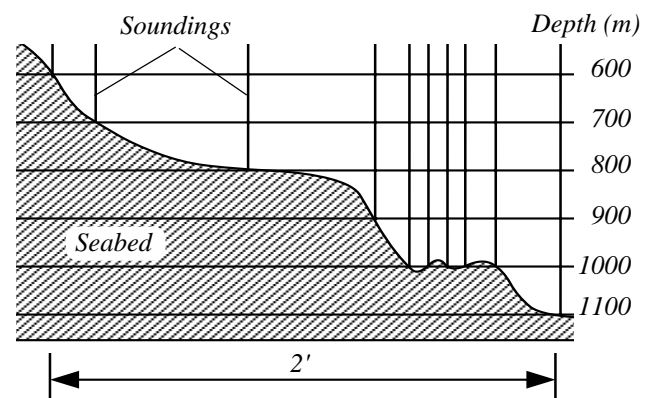

SECTION 1G: PLOTTING A BOTTOM CONTOUR MAP

The best way to interpret site survey data is to prepare a bottom contour map on graph paper. A contour map shows lines of equal water depth (isobaths) on the sea floor, and can be used to visualise the shape of the bottom and any suitable or unsuitable FAD deployment areas.

Although survey data could theoretically be transcribed straight onto a chart, the scale of most charts is too small to allow clear, accurate representation. Even on a chart of relatively large projection scale, say 1:80,000, a minute of latitude represents only about 25 mm, so our normal survey area (2' x 2') would be represented by a square of approximately 50 x 50 mm (minutes of latitude and minutes of longitude have the same length only at the equator, they do not have the same lengths at higher latitudes). Survey information is much clearer and less cluttered when transferred onto graph paper at a scale large enough to work with comfortably. Contour lines and other key features can then be referenced to the survey area's location by plotting the positions of the boundary corners.

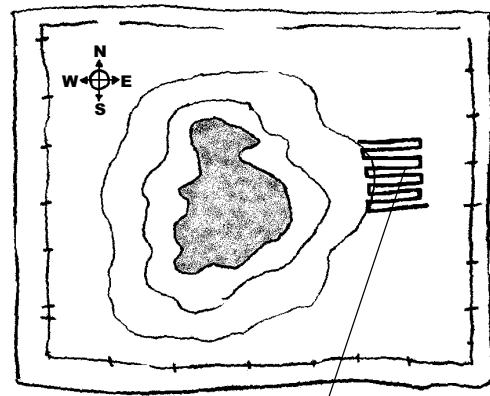

When transcribed onto a chart, survey data is too small for detailed working

The survey area should be plotted out on a sheet of graph paper so that the horizontal grid-lines correspond to lines of latitude and the vertical grid-lines to longitude. A scale should be chosen so that the survey area appears as big as possible on the graph paper. If a minute of latitude is measured on the chart at, say, 20 mm, it can be multiplied by, for example, 5 on the graph paper to be represented by 100 mm. If a minute of longitude is measured on the chart at 22 mm, it will be represented by 110 mm on the graph paper. In the end, the graph paper must represent a blown-up part of the chart showing the survey area transect lines in detail. Survey depths can then be marked on the graph according to their recorded positions, as shown in the diagram below.

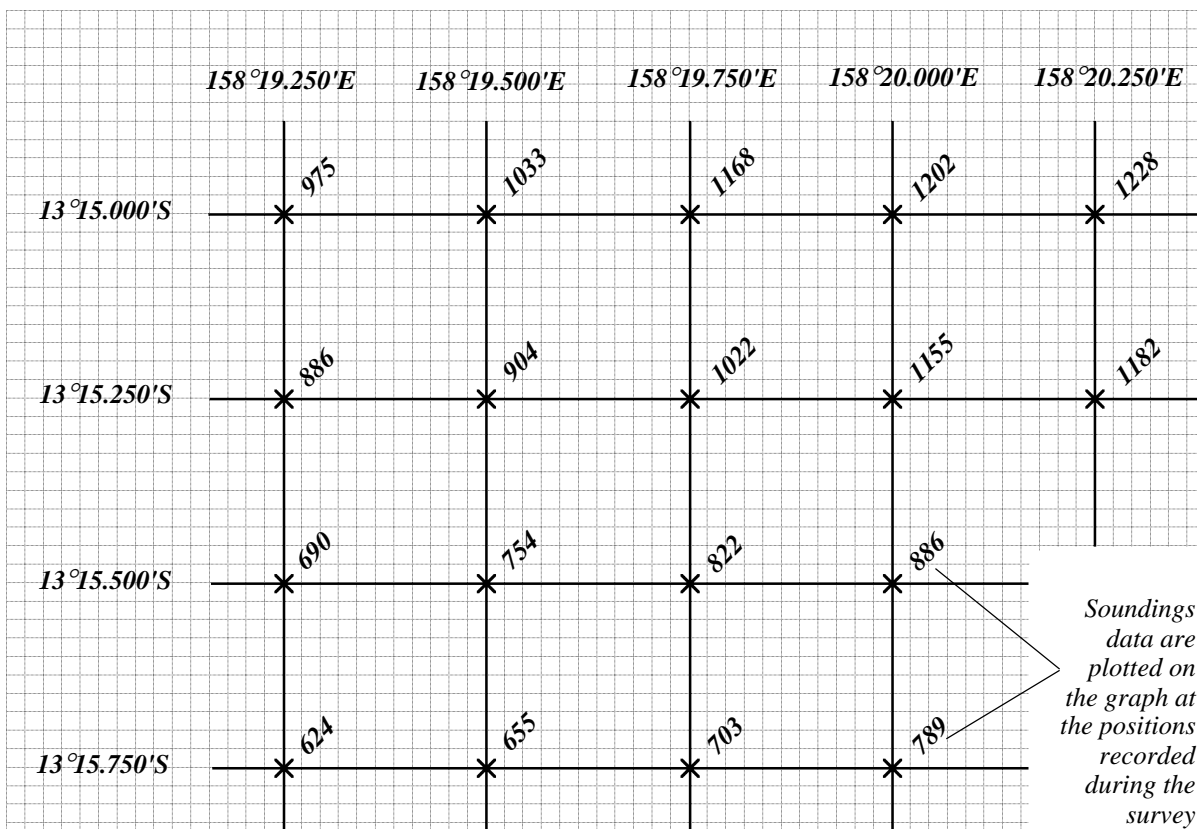

Surveying and graphing survey data is simplest when survey transects have been run N–S or E–W, parallel to lines of latitude and longitude, as mentioned in section 1E. If sea conditions, or other factors, have prevented the transects being run in a N–S or E–W direction, it is possible to run the transects in a NW–SE or NE–SW direction and still record depths at quarter-minute crossings, but precise navigation and plotting will be more complicated.

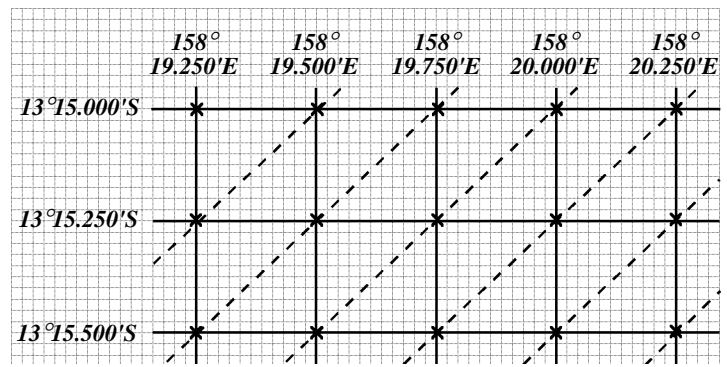

When all the survey depths are marked on the graph, the bottom contour lines can be drawn. This is done by connecting points of equal depth, using a chosen increment to separate the lines. For purposes of FAD deployment it is sufficient to draw lines that depict 100 metre depth intervals, i.e. the contour lines are drawn at 500 m, 600 m, 700 m, etc.

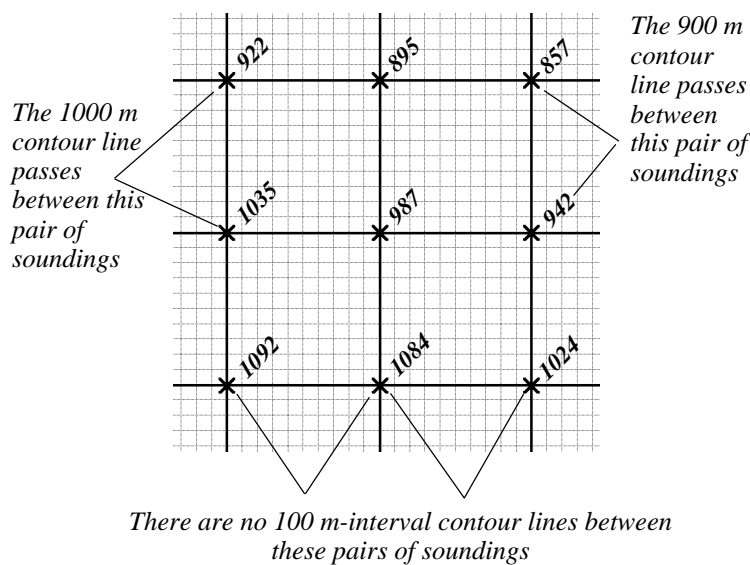

In fact depth readings that fall exactly on these 100 m contours are likely to be few and far between. Most readings will be between contours. The position of the contour lines is determined by ‘splitting the difference’ between such readings.

A simple example is as follows. If one depth reading is 995 m and another is 1005 m, we can estimate—assuming that the slope is regular—that the 1000 m contour lies exactly halfway between them.

Here is a more complicated example. One depth reading is 922 m, while the next is 1035 m. Again we can see that the 1000 m contour lies somewhere between them, but this time it is not so conveniently situated at the halfway point.

A simple calculation needs to be done to work out where it lies between the two readings:

- | | | | |
|---|---------------|-----|------|
| a) subtract the lower sounding from the higher sounding : | $1035 - 922$ | $=$ | 113 |
| b) subtract the lower sounding from the contour depth: | $1000 - 922$ | $=$ | 78 |
| c) divide the result of (b) by the result of (a): | $78 \div 113$ | $=$ | 0.69 |

This tells us that the 1000 m depth can be estimated to be situated at 0.69 of the distance between the two readings, starting from the lower reading. If the distance on the graph paper between the two readings is 20 mm, the 1000 m depth is thus 0.69×20 mm, or 13.8 mm distant from the lower reading, in the direction of the higher reading. The 1000 m mark is plotted at this position by counting millimeters on the graph paper or by using a ruler.

The process must be repeated for every pair of depth soundings on the graph. Once completed however, the contours of the seabed will become clear and can be examined for suitable FAD mooring sites, as discussed in section 1H.

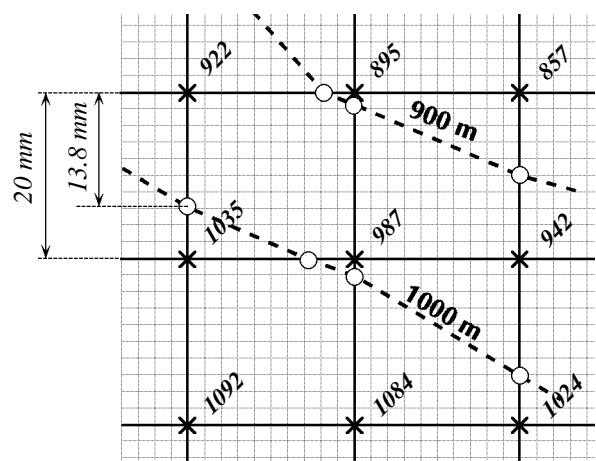

SECTION 1H: SELECTING THE DEPLOYMENT POSITION

Final selection of FAD sites is based on the bottom contour maps plotted as shown in section 1G. Broad flat basins, or gently sloping bottoms, without any ridges, pinnacles, crevices, nearby ledges or steep drop-offs, are the most preferable sites for FADs. The diagrams below show some examples of bottom contour maps, and the seafloor configurations they correspond to.

Broad flat or gently sloping areas...

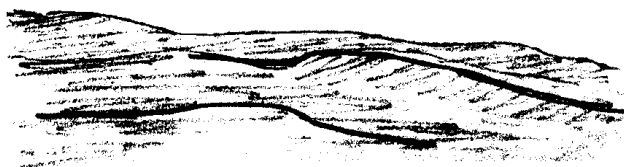

...are indicated by widely spaced contour lines.

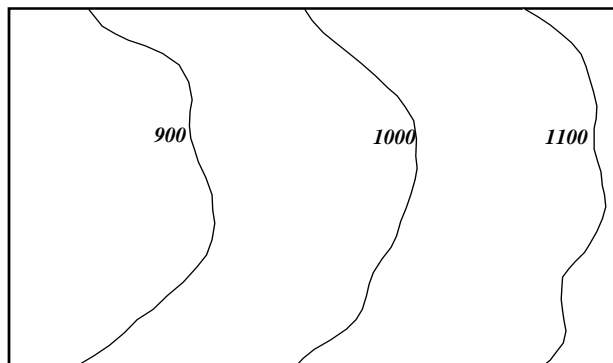

These are good for FAD moorings because there are no obstructions or dangers for the rope.

Steep slopes and abrupt ledges...



...are indicated by contour lines being close together. The closer together, the steeper the slope.

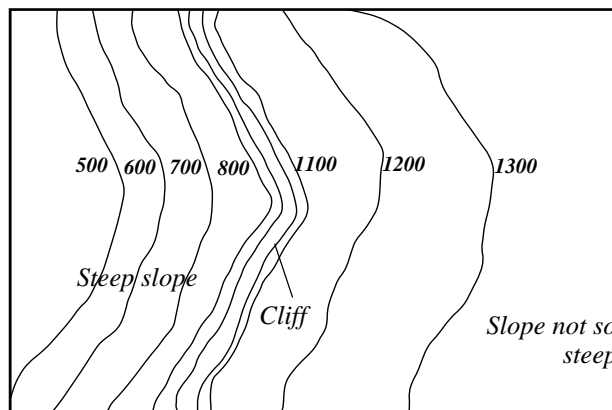

These are unsuitable FAD sites because the anchor may end up being deployed deeper than planned, or may be dragged into deep water by current and wind.

Pinnacles and ridges...

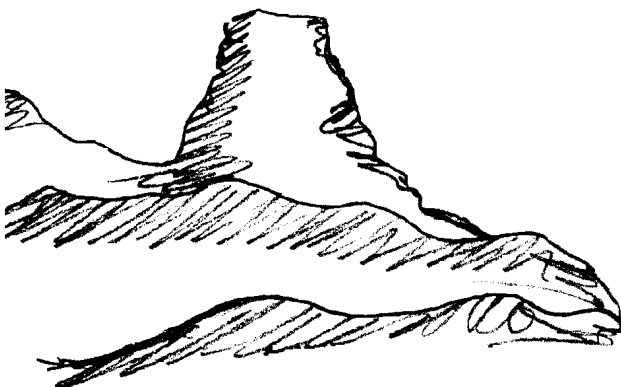

...appear as circular or elongated areas surrounded by closely packed contour lines, indicating steep drops.

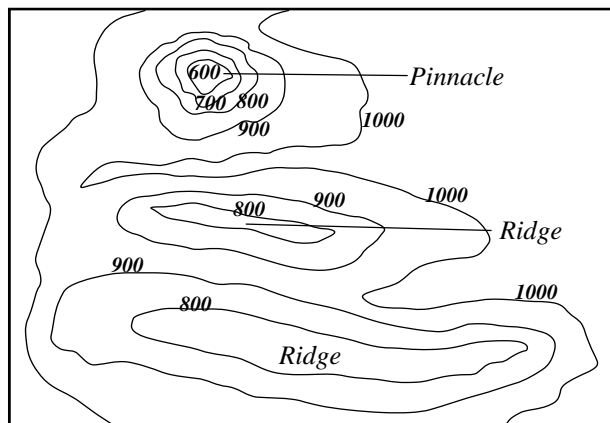

These are the worst FAD sites: as well as the dangers of anchor dragging, there is also a possibility of rope abrasion.

Two FAD scenarios

The diagrams below show information typically derived from site surveys, with indications of good FAD sites.

A 2' of latitude by 2' of longitude survey zone

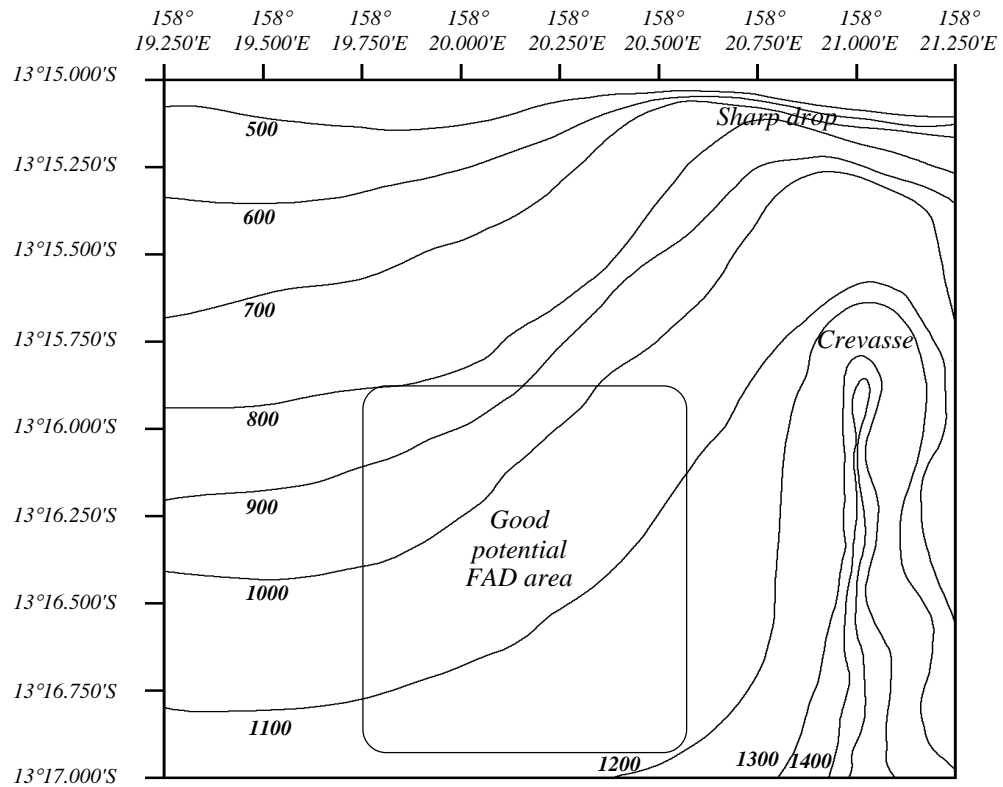

A 2' of latitude x 4' of longitude survey zone

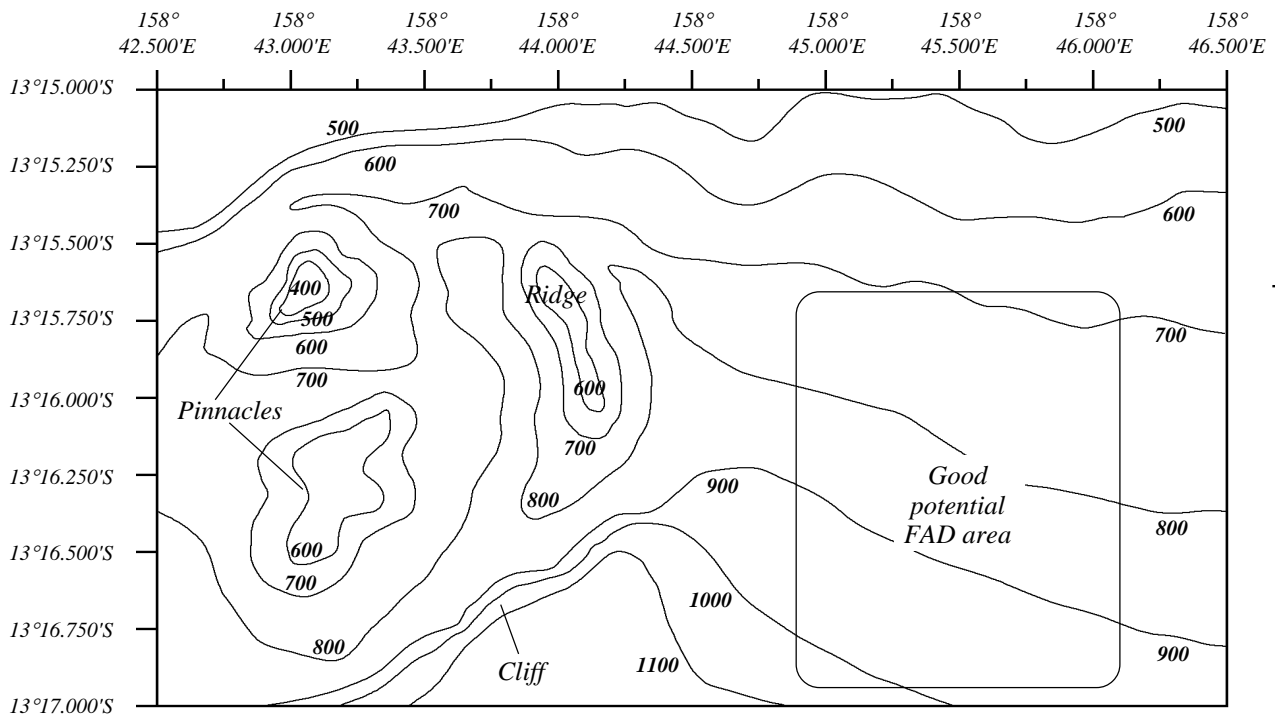

Once the site has been chosen, the FAD and the deployment vessel can be prepared and deployed as described in the next chapter.

CHAPTER 2

DEPLOYMENT

- A. FAD DESIGN CHARACTERISTICS**
- B. BASIC DEPLOYMENT TECHNIQUES**
- C. FACTORS AFFECTING ANCHOR PLACEMENT**
- D. CALCULATING BUOY DRIFT**
- E. MODIFICATIONS TO THE DEPLOYMENT TECHNIQUE**
- F. DEPLOYMENT VESSEL AND LAYOUT**
- G. PREPARING FAD COMPONENTS**
- H. DEPLOYMENT PROCEDURE**

INTRODUCTION

This chapter describes the factors that affect FAD deployment procedures and describes recommended deployment methods. Information on loading the FAD onto the deployment vessel and proper deployment preparation is also given.

SECTION 2A: FAD DESIGN CHARACTERISTICS

Based on extensive regional experience and study, SPC has made a number of recommendations regarding the design of FADs for use in the Pacific Islands region. These are discussed in detail in Volume II of the SPC FAD Manual, but are summarised very briefly below.

Anchors

It is recommended that a single rectangular block of concrete weighing at least 900 kg be used to anchor the FAD. The anchor should be as low and flat as possible to maximise ground-holding power. The common practice of using concrete-filled oil drums is discouraged as these can roll on the sea floor and drag the FAD into deep water.

Bottom chain and hardware

15 m of 19 mm dia. hot-dip galvanised long-link, proof-coil, low-carbon steel chain is used to connect the anchor to the mooring rope. Connections are made using an appropriate combination of safety shackles, swivels and rope-protector thimbles as shown in the diagram opposite.

Rope

The recommended mooring rope consists of two parts: a lower section made of 22 mm dia. 8 or 12-strand plaited polypropylene (which floats); and an upper section made of 19 mm dia. 8- or 12-strand plaited nylon (which sinks). The floating lower section has enough buoyancy to lift the end of the bottom chain off the sea floor, thus preventing abrasion of the end of the rope, while the sinking upper section hangs down out of the way of possible damage or interference at the surface. Where the two ropes are joined by splicing, a gentle 'catenary' curve is formed which acts to absorb slack line during calm weather and releases it when conditions are rough.

Three-strand twisted rope is never recommended for moorings because of its inherent tendency to twist, kink, and hockle. Plaited ropes are torque-balanced and cannot hockle.

Rope-length calculations

Volume II of the SPC FAD Manual contains a table showing the total length of mooring rope needed for various water depths, as well as the correct lengths of the nylon and polypropylene parts (calculated to provide the right amount of buoyancy) when the SPC-recommended ropes are used. In all cases the total length of the rope is 25 per cent greater than the site depth. This provides a safety margin in case the anchor lands in a depth slightly greater than expected, and gives enough scope so that the raft does not pull vertically on the anchor when weather conditions are extreme.

Rafts and upper hardware

SPC recommends either of two different raft types:

- A 'spar' buoy constructed of welded 5 mm thick steel plate. The circular body of the raft is 150 cm in diameter and 60 cm high, and is fitted with a galvanised pipe mast which extends 180 cm above the body and 105 cm below it. The raft is fitted with a battery-operated, solar-activated flashing light, as well as a radar reflector. Because of its form this raft must have a 15 m length of chain attached to the bottom of the mast extension to prevent it capsizing.
- The 'Indian Ocean' style raft is made from a string of floats with holes through them, threaded onto a length of wire rope. The SPC-recommended design uses 50 Casamar model C6000 purse-seine floats. These are threaded on a 30 m length of 16 mm dia. steel wire rope sheathed with PVC to bring the total diameter to 32 mm. The raft just has a simple flagpole, with no lights or radar reflector. The raft cannot capsize, and the mooring end of the steel wire rope hangs vertically down well below the sea surface, so there is no need for chain at the upper end.

Recommended design

The recommended FAD mooring and raft designs are illustrated on the opposite page. The descriptions of deployment given in the rest of this manual generally assume that this mooring, fitted with a steel spar buoy as described above, is the design being used.

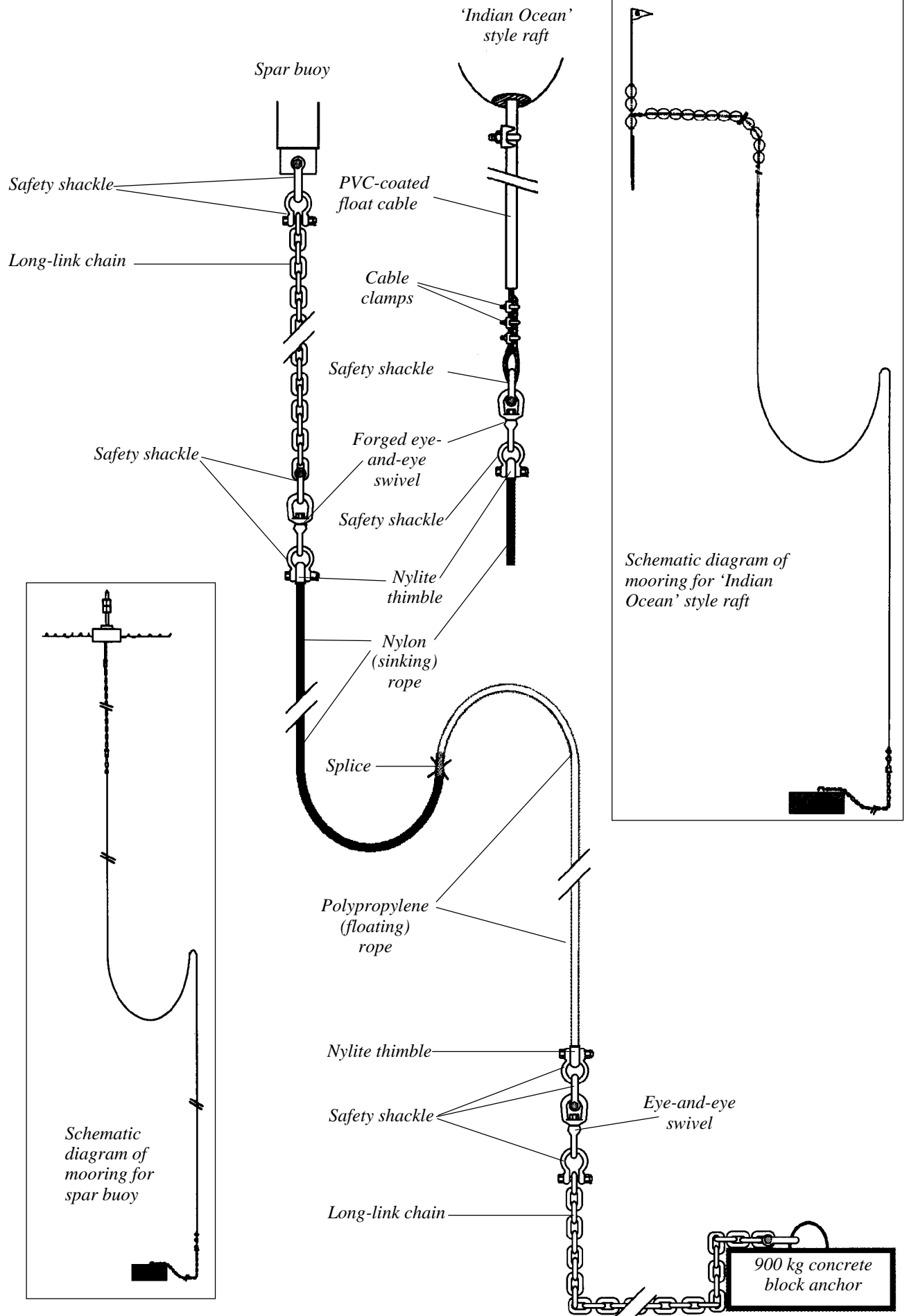

SECTION 2B: BASIC DEPLOYMENT TECHNIQUES

FAD deployments involve a coordinated sequence of events. Some variation may exist in the details or timing of these events, depending on the layout of the deployment vessel, the amount of open deck space available, the method used to deploy the anchor, and, in some cases, sea conditions and travel distance to the deployment site. Nonetheless the basic sequence of events is essentially universal, and is dictated by considerations of crew and vessel safety as well as of efficient, trouble-free deployment of the FAD.

There are two principal deployment methods: the **anchor-first** and **anchor-last** techniques.

Anchor-first deployments

In anchor-first deployments the anchor is heaved overboard first. The mooring rope, faked (laid out for free running) bottom-end up, is pulled overboard by the weight of the anchor and pays out as fast as the anchor drops toward the seabed. Once the anchor settles on the bottom any remaining mooring line still on board the vessel, followed by the upper chain and buoy, are deployed.

The anchor-first method has sometimes been used in situations where the water depth is not known. In this case the upper chain and buoy are not attached to the mooring line until the anchor is on the bottom. Once the anchor lands, the mooring rope is drawn tight, a measured amount of slack is paid out, and the end of the line is connected to the upper chain and the buoy, which are then deployed.

The anchor-first deployment allows relatively accurate positioning of the FAD anchor at the deployment site, but much can go wrong once the anchor is let go. The anchor falls quickly, and few vessels that deploy FADs are equipped with gear that can slow or stop an anchor once it starts its descent. If someone gets caught in the rope, or the rope becomes tangled, or a hook-up occurs, there is little chance of being able to do anything about it.

Anchor-first deployments are dangerous for small vessels and SPC recommends against them. Apart from this brief description, the anchor-first technique will not be discussed any further in this manual.

Anchor-last deployments

In anchor-last deployments the FAD raft is deployed first and the mooring paid out as the vessel steams away from it. Wherever possible the line of deployment should follow the depth contour in which the FAD is to be deployed. For instance, if the intended FAD site is 1,000 m deep, then the vessel should try to steam along the 1,000 m contour line, as long as other circumstances permit. Once all the mooring line is in the water the anchor is deployed at the position which confers the greatest probability of it landing at the desired depth and location.

In anchor-last deployments the buoy is deployed first...

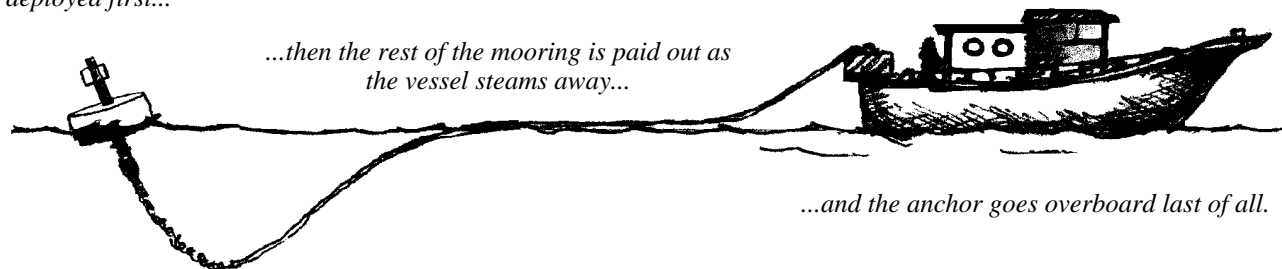

Anchor-last deployments are much safer than anchor-first methods and permit adjustments during the deployment process. If problems arise with gear, or if sea conditions become unfavourable during the deployment it can be aborted, with mooring and buoy being hauled back aboard the vessel. Anchor-last deployment is the technique recommended by SPC.

SECTION 2C: FACTORS AFFECTING ANCHOR PLACEMENT

There are several important factors which affect the way in which anchor-last FAD deployments are carried out, and the place where the anchor will come to rest on the seabed.

Mooring tension

As the anchor sinks after being deployed, the drag caused by the mooring rope increases dramatically. Engineering studies have shown that, once the anchor is let go, tension on the mooring increases steadily as the anchor descends and reaches its highest point just before the moment of impact, when it is about equal to the static weight of the anchor.

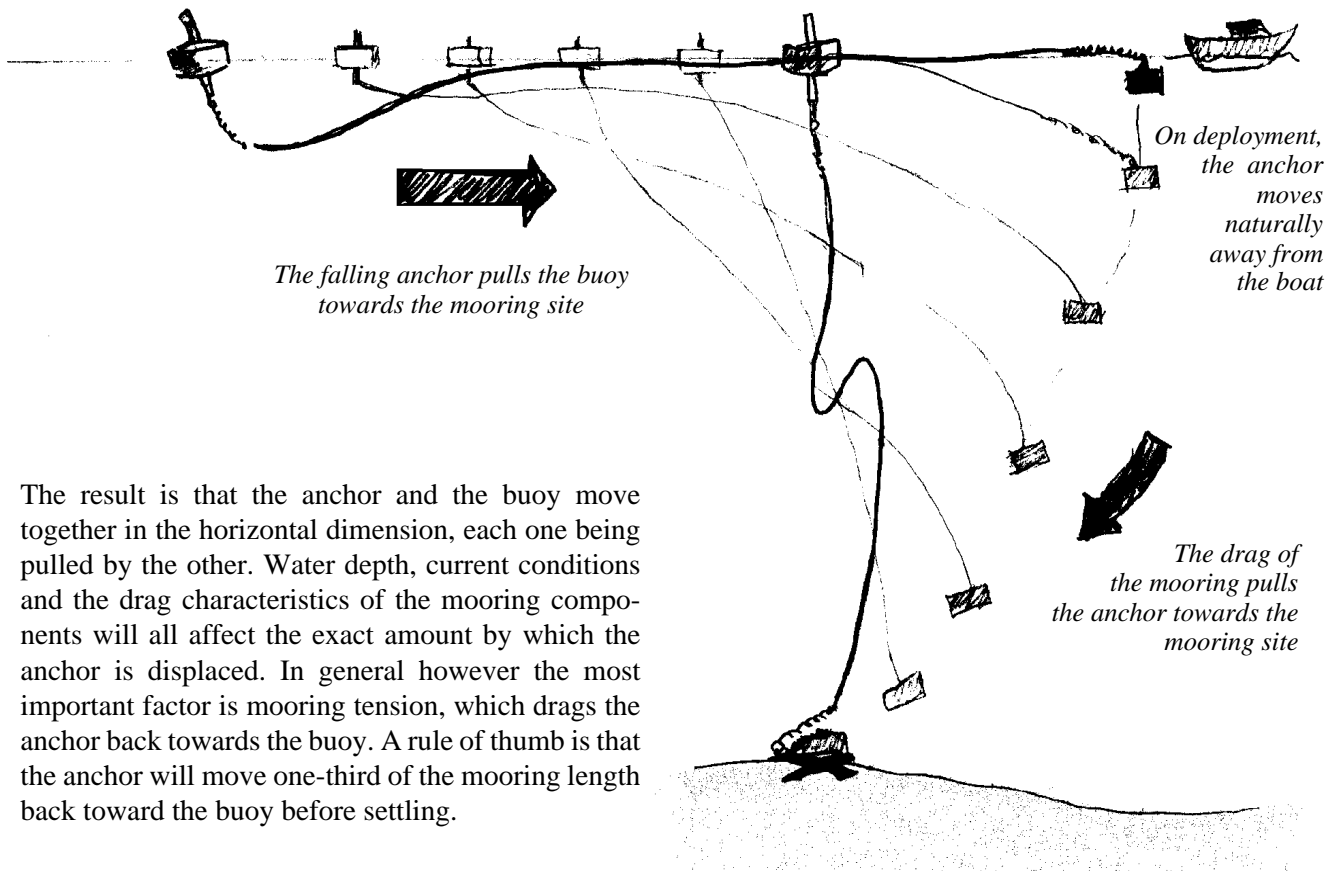
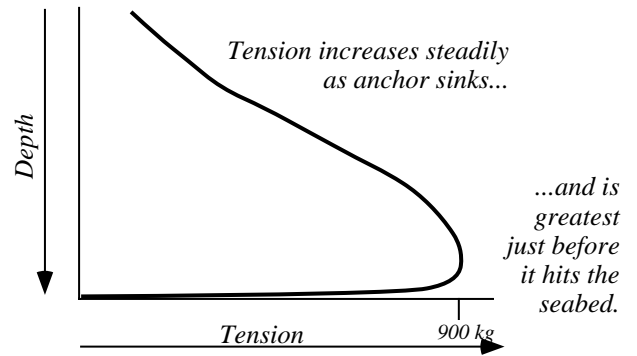

The result is that the anchor and the buoy move together in the horizontal dimension, each one being pulled by the other. Water depth, current conditions and the drag characteristics of the mooring components will all affect the exact amount by which the anchor is displaced. In general however the most important factor is mooring tension, which drags the anchor back towards the buoy. A rule of thumb is that the anchor will move one-third of the mooring length back toward the buoy before settling.

Anchor orients itself to be less resistant to water flow...

...flow becomes turbulent..

...and anchor swings to opposite position

Anchor's descent is pendular (swinging back and forth)

Anchor motion

When the anchor is heaved over the side it does not sink to the bottom in a straight vertical path. The descent is governed by hydrodynamic principles, the anchor's shape, the surface area of the base, and the flow of water around it. Water resistance tends to shift the orientation of the anchor block so that it poses less resistance to the water flowing past. The motion continues until water flow on one side of the anchor becomes turbulent. Then the same forces swing the anchor to the other side. This repeating cycle causes the anchor to swing with a pendulum-like motion during its descent, which in deep water may take more than 15 minutes.

SECTION 2D: CALCULATING BUOY DRIFT

Unless there is absolutely no wind or surface current, the FAD buoy and mooring will begin to drift as soon as deployment commences. The direction of drift depends on the strength and direction of wind and current, but will be influenced more strongly by the current. This is because a large proportion of the buoy's surface area is under water, and because as soon as the deployment starts the rope and chain will add to the current drag. Unless the wind is very strong—which is unlikely, since FAD deployment would not normally be done in such conditions—then it can be assumed that the direction of drift of the buoy will be the same as that of the surface current.

It is easy to estimate the surface current by tracking the movement of a plastic bucket attached to a small float using a metre or so of light cord. As long as the float is small and has little exposure to the wind, the bucket will drift mainly under the influence of the current and will give a good indication of both its direction and its strength.

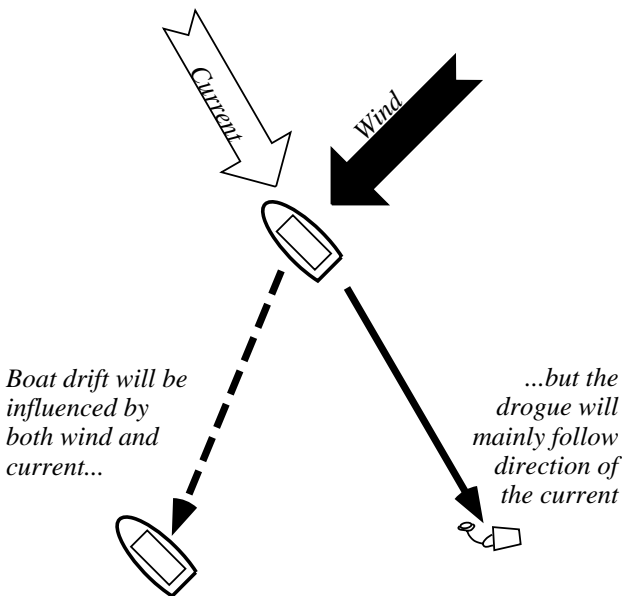
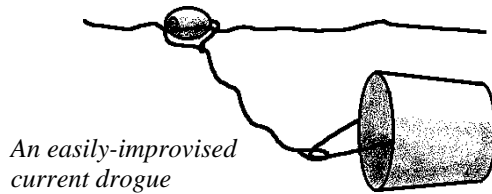

The procedure for estimating surface current is as follows.

- put the vessel into neutral and allow it to come to a stop somewhere close to the FAD deployment site;
- fix the position of the vessel with the GPS;
- immediately release the bucket/ float assembly;
- after a set period of time—say ten minutes—run the vessel over to the bucket and, before recovering it, record its new position and the time it has been drifting;
- estimate the direction of the current by plotting the bucket's start and finish positions on a chart and then taking the relative bearing between them;
- estimate the speed of the current by measuring the distance between the bucket's start and finish points and dividing this by the time the bucket drifted.

The method above only estimates the surface current. In most places there are several sub-surface current layers, which may flow in different, or even opposing directions. The deeper the site, the more current layers are likely to be encountered. There are no practical ways to predict the directions of sub-surface currents, but under normal circumstances they will be less important for the placement of the FAD than the surface current. This is because the FAD spends more time in the surface current layer during the deployment of the mooring, while the period of influence of sub-surface currents is limited to the time the anchor spends sinking.

In a standard anchor-last deployment the vessel positions itself down-current of the FAD site, releases the buoy, and then steams up-current towards the FAD site, while the buoy drifts down-current and away from the vessel. The rest of the mooring is deployed along a track that will pass directly over the designated mooring site and to the anchor-drop position.

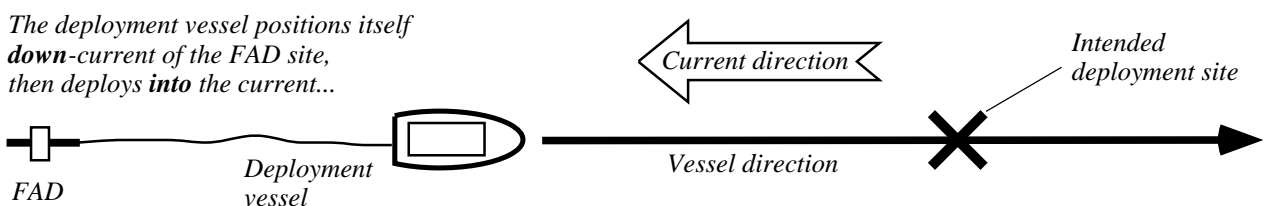

The exact direction of the deployment line will depend to some degree on the bottom topography. It is desirable to follow the lines of bottom contour wherever possible, so a compromise between current direction and contour orientation may have to be made if these are not aligned with each other.

SECTION 2E: MODIFICATIONS TO THE DEPLOYMENT TECHNIQUE

Mooring tension, anchor swing and current drag must be taken into account during the deployment procedure. The result is that, during a FAD deployment, neither the buoy nor the anchor is actually released at the intended FAD site—although of course this is where the FAD is meant to end up after the various factors have played their parts.

Deployment actually takes place in a straight line running opposite to the direction of expected buoy drift. The buoy is deployed down-current of the intended FAD site at a distance equal to two-thirds of the mooring length. The deployment vessel then heads up-current, freely paying out the mooring rope so that there is little or no drag, and taking care not to tow the buoy along behind it.

While paying out the mooring rope the deployment vessel passes over the intended FAD site, but keeps on going until all the rope has been paid out. At this point, if the calculations have been done correctly, the vessel will be up-current of the FAD site at a distance of one-third of the mooring length. This is the anchor drop point, where the bottom chain and then, finally, the anchor, are deployed.

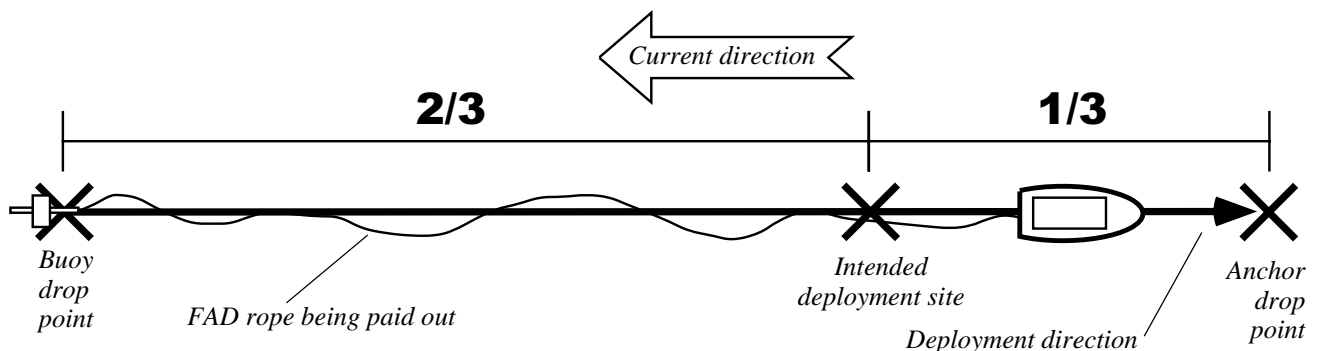

Since the length of the mooring is already known, working out the correct positions of the buoy-drop and anchor-drop spots is not complicated once the direction of buoy drift has been determined. When the positions have been calculated they can be entered into the GPS, with the buoy drop position serving as the start point, the FAD site as a waypoint, and the anchor drop position as the final destination. The GPS will then guide the vessel along the correct path and indicate the drop points for the buoy and anchor.

Non-linear deployments

The straight-line deployment method is most suitable when FAD sites are broad and flat, since in these cases the unavoidable inaccuracy in anchor placement is not critical. In narrow, steeply sloping sites, or very deep sites the straight-line technique may involve too great a risk of having the FAD end up in excessively deep water, or being lost altogether. A number of variations have therefore been developed to try to reduce the risk of the anchor landing deeper than planned. These generally involve deploying the FAD in a non-linear path, so that the mooring line is paid out over waters shallower than the intended FAD site. The deployment path may be a circle, a hairpin, a zig-zag line or some other configuration.

Alternative deployment paths

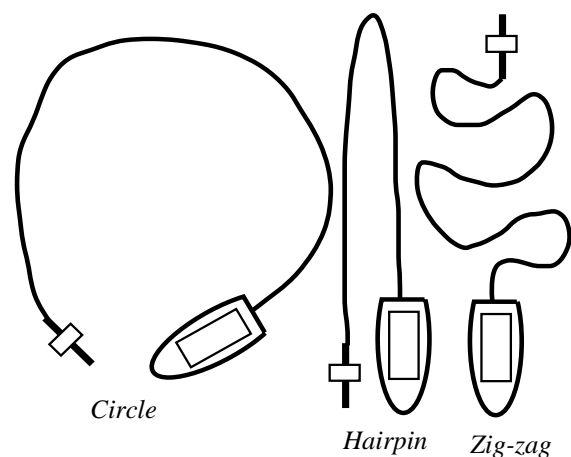

Non-linear deployments are intended to shorten the overall distance between buoy and anchor, and to use the force of mooring tension to drag the anchor into shallower waters. In theory the net result is that any error in anchor placement tends to be towards shallow waters, thus avoiding loss of the FAD. However there continues to be disagreement among people who have deployed FADs about the real usefulness of such techniques.

Non-linear deployments increase the chance of the mooring line fouling or tangling on the deployment vessel, so in general they should be used as a second choice to straight-line deployments.

SECTION 2F: DEPLOYMENT VESSEL AND LAYOUT

FAD deployment requires thorough planning and a coordinated effort by the deployment team. The FAD must be arranged and securely stowed while the vessel is at the dock so that the deployment operation will proceed smoothly and safely. Time should be taken to double-check the layout of the FAD, on-board equipment, and mooring connections. Safety of the crew and vessel and operational efficiency are the main concerns during deployment operations. Poor preparation and layout arrangements can lead to accidents or premature loss of the FAD.

Suitable vessel types

A variety of vessels can be used for FAD deployments. Although larger vessels and their on-board equipment, such as winches and derricks, make handling of heavy components easier, FADs can also be deployed from smaller vessels. The essential requirements are that the boat should be capable of transporting the anchor, buoy and the bulky chain and rope, which together may weigh almost two tonnes, safely and with enough working space to allow deployment of all this gear overboard without danger to the crew. Even very small vessels can sometimes be used for FAD deployment if they use a towing bridle to tow the buoy to the site, as shown in section 2G, rather than stowing it on board. Towed barges can also be practical deployment platforms due to their stability, large deck space, and ease of overboard access.

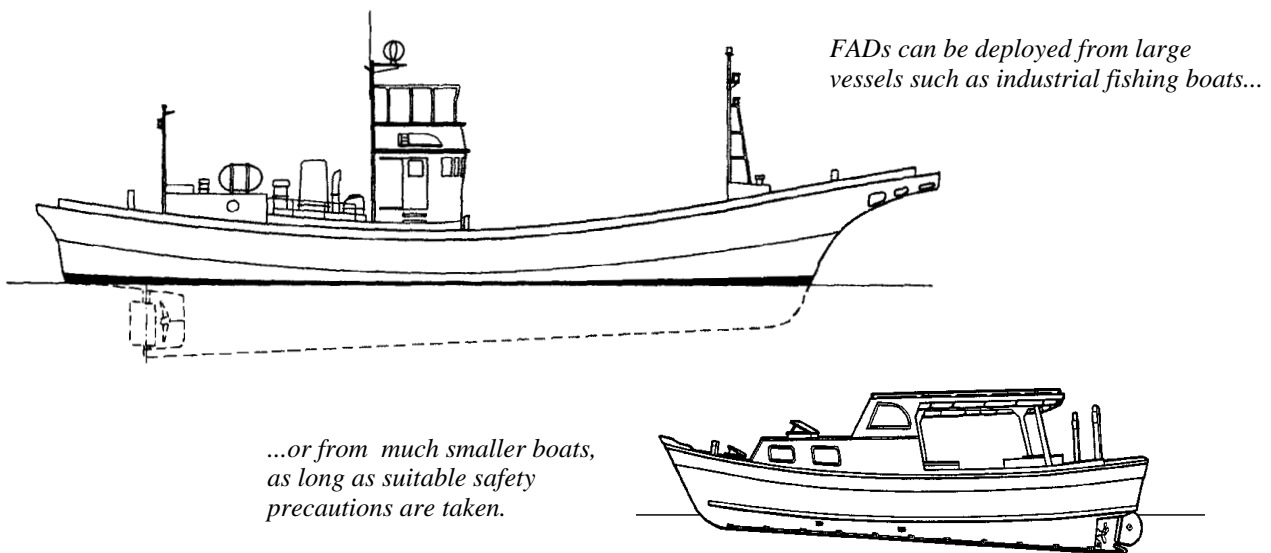

General guidelines

The actual on-board arrangement of the FAD depends on the deck layout of the deployment vessel. Nonetheless, some general guidelines exist irrespective of the vessel's particulars:

- FAD layout should flow in a logical pattern so that the buoy is the first item to go overboard, followed by the upper chain, the mooring line, the bottom chain and, finally, the anchor;
- the entire mooring should pay out along an unobstructed path;
- any extraneous gear should be removed from the FAD layout area, and the deck in general should be kept as clear as possible;
- care should be taken to ensure that the mooring rope will not pass over any sharp edges which could cut or nick it during deployment;
- the anchor should be placed and prepared so it will deploy cleanly, where it will not cause damage to the vessel or hook-up on anything;
- the FAD should be arranged so that during the deployment no-one ever has to position himself between the FAD components and the point where they are going over the side.

Each of the measures listed above is very important for safe, efficient FAD deployments. A clear, unobstructed deployment area, and a carefully thought-out FAD arrangement will prevent damage to the mooring and will not jeopardise the safety of the crew.

Vessel layout

The diagrams below illustrate possible FAD arrangements for two deployment vessels of different sizes and with different deck layouts. The FAD arrangement follows a logical sequence from buoy to anchor, the same order in which the FAD will be deployed.

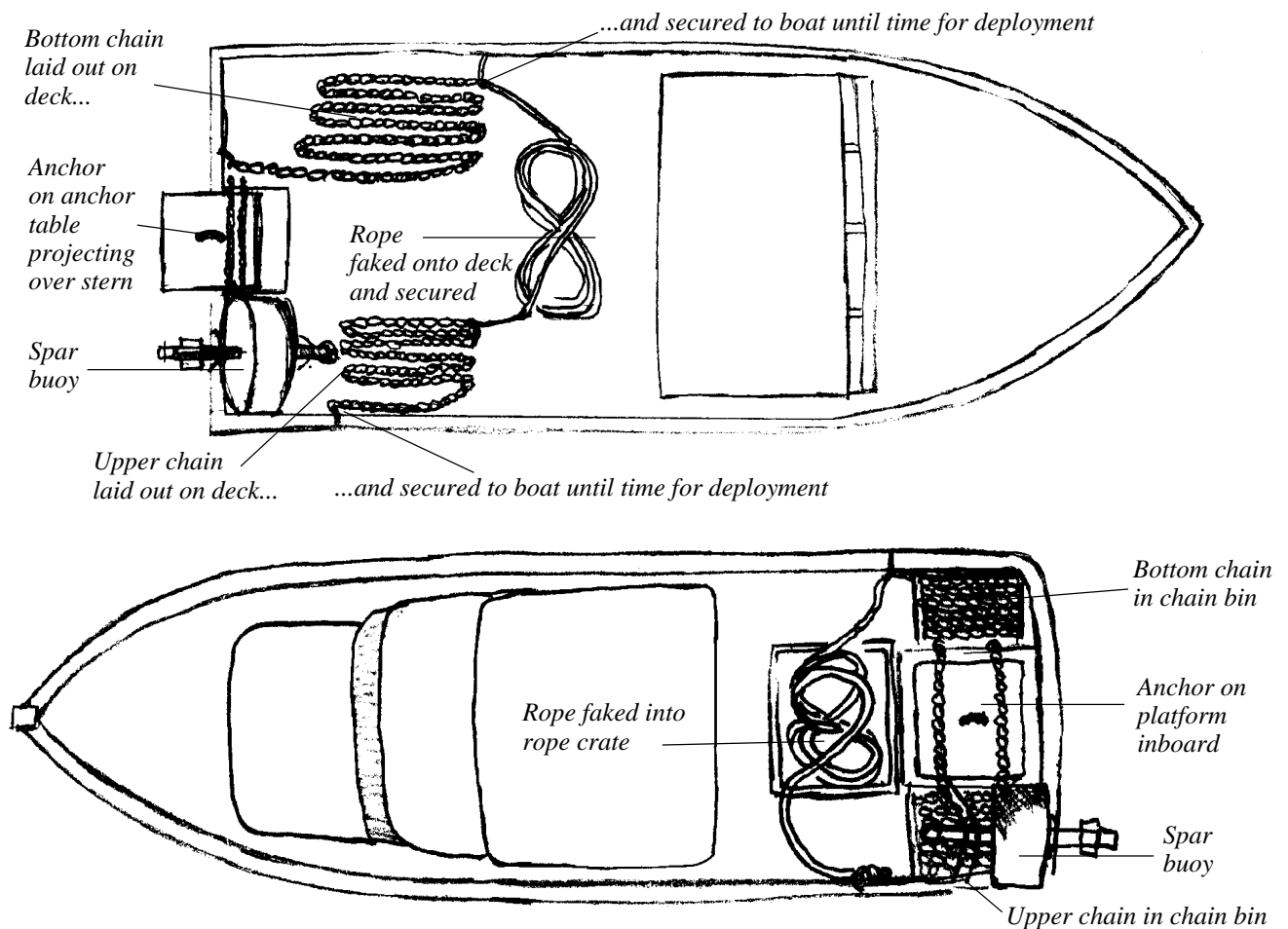

General sequence of events

The FAD is loaded onto the deployment vessel. Chain and rope are generally deployed either directly from the deck or from crates or boxes placed strategically on the vessel for this purpose, and need to be faked so that they will run out freely during deployment. If necessary the chain or rope is secured so that it will not shift when the vessel is running. The anchor and then the buoy are loaded, positioned, and also secured for running.

If a small vessel is being used, all connections between FAD hardware components are made before or just after loading, while the vessel is still at the dock, so that welding equipment can be used to seal all the safety shackle pins. If a larger vessel with on-board power and welding equipment is to be used then the assembly of hardware components can take place at sea immediately prior to deployment. This may make the loading and stowage of FAD components easier, especially if multiple deployments are to be made.

Once the vessel is close to the deployment site the FAD components are prepared for deployment. Any unfinished assembly work is completed and tie-downs or securing ropes are removed so that the deployment procedure can begin, as described in section 2H.

Hook-ups

If a part of the mooring, whether it be rope or a hardware component, were to get caught on some part of the boat during deployment it would almost certainly damage the mooring and cause a potentially dangerous situation. FAD layout arrangements should try to minimise the potential for such hook-ups, and must take into account the safety of any individual who might have to free them. Carefully conceived FAD layouts will go a long way in preventing such incidents from occurring.

SECTION 2G: PREPARING FAD COMPONENTS

The following paragraphs describe specific aspects of the handling and stowage of FAD components on board the deployment vessel.

The FAD buoy

The buoy should be stowed close to its deployment location, so that only minimal manoeuvring is required during deployment. On many vessels the port or starboard quarter is a logical location. The buoy should be secured in place using heavy rope or strapping. A sheet of scrap plywood between the buoy and the deck may reduce friction damage to both, especially if they are made from steel.

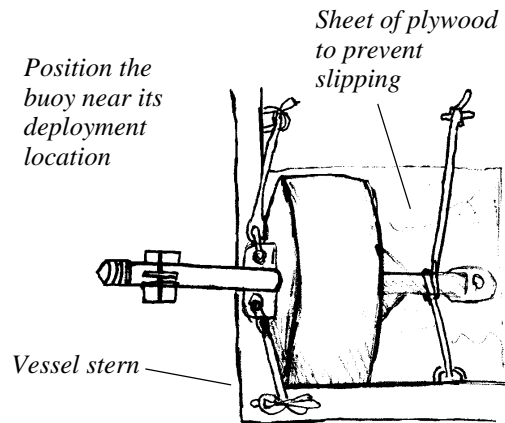

If the deployment vessel is small the buoy may have to be towed to the deployment site. In that case a towing bridle made from heavy rope or cable should be used. The bridle should be attached to several points on and around the buoy to avoid putting too much stress on any one point, including the lifting eyes.

When leaving port, or passing through areas where the vessel must manoeuvre, the buoy should be towed close (no more than 10 m away) to the stern of the deployment vessel, which should proceed slowly. Once out to sea the tow rope should be lengthened to match the length of the waves so that the buoy and vessel remain in step, riding over crests and troughs at the same time. If the buoy is in a trough while the ship is on a crest, the tow line will repeatedly slacken and then suddenly jerk taut, exerting stress on the tow line and the buoy.

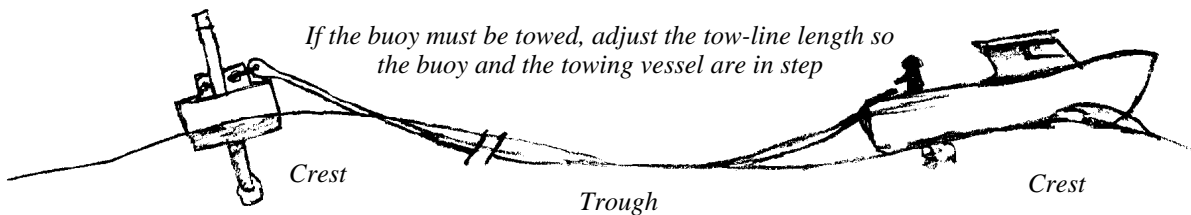

Chain and rope

The most usual way of storing chain and rope is to fake them straight onto the deployment vessel's deck, where they are tied down during transport. On arrival at the FAD site they are untied and deployed straight from the deck. Alternatively, if deck space is limited or if there is a danger of them going over the side, they can be deployed from chain and rope bins set up specially for the purpose. Chain bins can be shallow, sturdy wooden boxes, or can be improvised from the cut ends of robust plastic barrels or 200-litre oil drums. The rope bin can be a built-in fish hold, a specially fabricated box, or some other large container.

Use a spool or turntable to remove rope from coils

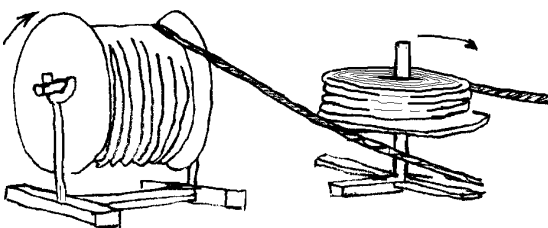

Rope should be properly uncoiled or unspooled and faked onto the vessel in large (2 metre) loops or bends. If the rope is on a spool a pipe can be inserted through the spool's centre so that the rope can be pulled off. If the rope is in a coil, a makeshift turntable should be improvised so that the rope can be unwound from the outside without putting twists into it. (A wooden fishing handreel turned on its side can be used as a turntable for small coils).

If braided rope is not available and three-strand rope is being used then it should be laid out in figure-of-eight fakes, which will prevent putting any twists into the rope. Making a figure-of-eight fake involves alternating clockwise and anti-clockwise turns in the rope.

Figure-8 fake will not introduce twists...



...and is best for 3-strand rope.

Normally the most logical position for the rope is on the after deck, since the rope will usually be deployed from this area.

Chain quick-releases

At several points during the deployment there is the possibility that part of a chain section could get pulled over the side and start feeding into the water before it should, causing a troublesome and potentially dangerous situation. For this reason quick-release attachments should be used to secure the chain to strong points on the vessel at critical places along the chain's length.

Hardware items such as snap shackles or pelican hooks can be used as quick-releases, but a length of rope passed through a chain link and then attached to a strong point so that it can be quickly untied or cut off will do just as well. The main requirements are that the release be strong enough to hold the weight of a section of the chain to prevent it deploying ahead of schedule, and that it can be quickly let go when needed.



Various types of snap shackle which can be used as quick-releases

Normally a quick-release should be attached on the upper chain, about 8 or 10 m below the buoy connection, and at the point where the lower end of the FAD rope is connected to the bottom chain. Other quick-releases may also be desirable depending on the specific features of the deployment vessel and procedure.

Anchor

Unless the deployment vessel is equipped with its own gear capable of lifting a tonne or more, the anchor should be set ready for deployment while the vessel is at the dockside, and attached firmly in place using ropes and chains. Anchors are most likely to move from side to side as the vessel rolls on the way to the deployment site, so special attention should be paid to securing the anchor to prevent movement in this direction.

On most boats the logical and stable placement for the anchor is amidships along the stern, either directly on deck or supported slightly above the transom. However on many vessels the rudder protrudes past the stern and the anchor cannot simply be dropped over the back without causing damage. In such cases anchors can be deployed from any number of spots around the vessel, so long as sufficient clear deck area exists and the placement of the anchor does not affect the vessel's stability.

On a large vessel with lifting gear the anchor can be hoisted on the vessel's crane or derrick, swung over the side, and let free. In most cases, however, FADs are deployed from vessels without such equipment, so special preparations need to be made to allow the controlled release of the anchor without injury, damage or other mishap.

The simplest method is to construct a solid wooden stand or table at the stern of the vessel. This should be just a little higher than the transom and should extend over it so that when the anchor is deployed it does not do any damage. The table should be fixed firmly in place with appropriate attachments and tie-downs. The top of the table can be given a slight (15° or so) slope to the stern, to make anchor deployment easier. The anchor is placed on the table at the dockside using a loading crane, and is secured firmly in place before departure.

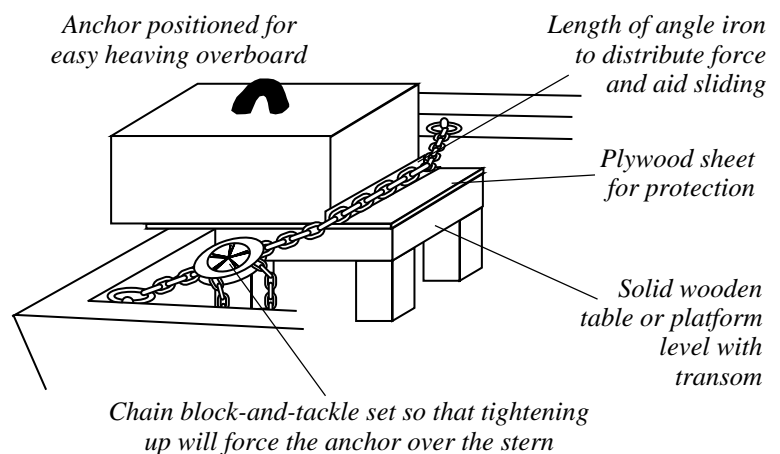

If possible the anchor's centre of gravity should be close to the stern of the vessel or even slightly outboard so that when it is freed it can be easily pulled overboard by the weight of the deployed bottom chain, helped by the crew using crowbars or strong pipes for leverage. However if for safety or other reasons the anchor cannot be positioned hanging over the stern, then extra force may be needed to deploy it. This can be provided by a chain block-and-tackle rigged up between the stern cleats, with the chain lying behind the anchor so that when tightened up it pushes the anchor over the stern. A length of angle-iron placed between the chain and the anchor will help the chain to slide, and protect the deployment table and anchor corners from damage.

SECTION 2H: DEPLOYMENT PROCEDURE

Once all the preparations have been made as described in the preceding sections of chapter 2, the actual FAD deployment takes place as follows:

The vessel makes way to the designated FAD mooring site, to verify the site and determine the direction of buoy drift. A check of the depth at the designated site is made first, using the echo-sounder. Ideally two short crossing transects should be run at right angles, one of them oriented in the same direction as the original site survey transects, with the designated mooring site located where the transects intersect. The depth readings should correspond to those obtained during the site survey process. If they don't, then the vessel may not be at the right site.

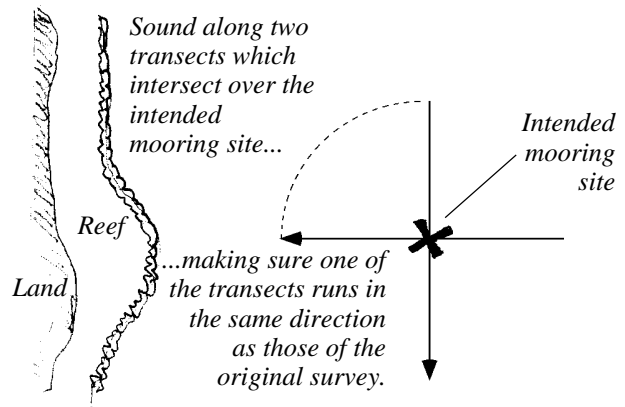

Once the site has been verified, the vessel is positioned at the designated FAD mooring site and the GPS is used to determine the likely direction of buoy drift, as described in section 2D. The estimated direction of drift is recorded and plotted on the navigational chart.

Next, the point at which the vessel will start deploying the FAD (by releasing the buoy) is determined. This is a point directly down-current of the FAD site, along the line of buoy drift, and at a distance of two-thirds the total length of the mooring. For instance in the case of a FAD mooring that is 1,200 m long, the start point would be 800 m straight down-current of the designated FAD site.

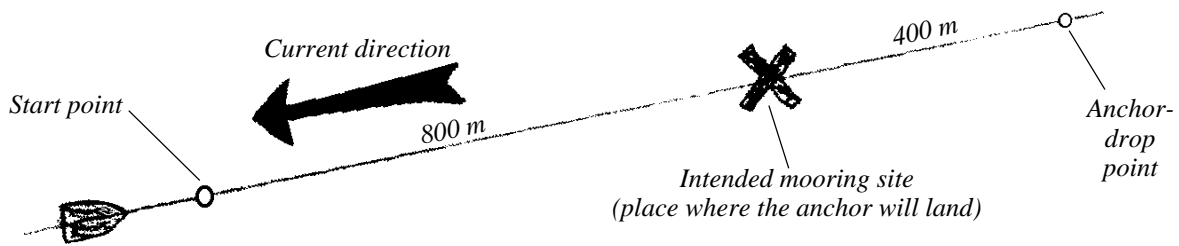

The anchor-drop position is also determined, up-current from the designated FAD site at a distance of one-third the mooring length. In the case of a 1,200 m mooring, the anchor drop site will be 400 m up-current of the intended FAD site.

The drop positions are programmed into the GPS unit. The vessel then makes way to the start position, and begins the process of deploying the FAD. The first step is to untie the FAD buoy and free the upper mooring chain. Once this has been done the upper chain and a corresponding length of rope are lowered into the water while the vessel moves very slowly forward. The buoy is deployed overboard, and the vessel sets off on an up-current heading for the designated mooring site and anchor-drop site.

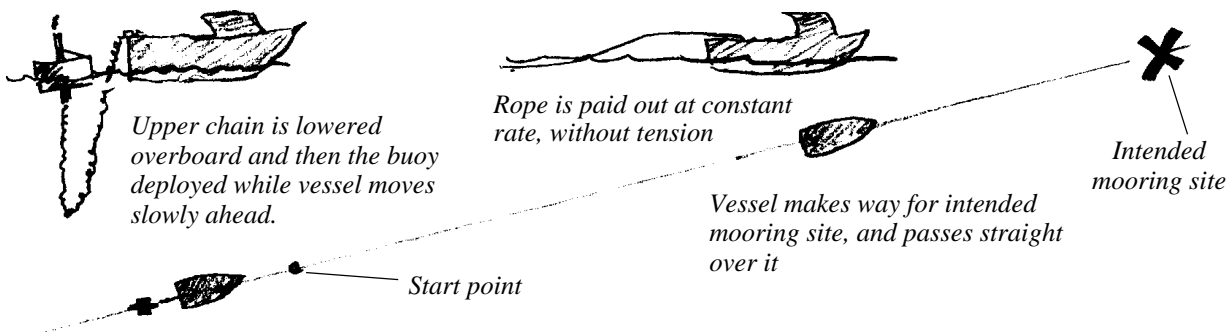

The vessel makes way along the up-current heading, maintaining a constant slow rate of speed while the rest of the mooring rope is paid out. The vessel's rate of speed must allow the mooring rope to deploy naturally, and without significant tension. Care must be taken not to tow the buoy along behind the boat while the mooring is paying out, since this will cause the vessel to arrive at the anchor-drop site with rope still on-board. In addition, if 3-strand rope is being used, the stretching of the rope caused by towing can introduce twists which may cause tangles later on.

The vessel passes directly over the designated mooring site as it makes its way toward the anchor-drop position. By the time the vessel nears this point the last part of the mooring rope should be going over the side. If the rope runs out too soon it may be necessary to tow the mooring a short distance until the anchor-drop point is reached. If towing has to be done, it should be done very slowly to minimise tension on the mooring rope.

At this point the vessel is slowed down while the bottom chain and anchor are prepared for deployment as quickly as possible. This is the most dangerous part of the deployment and the one where there is most potential for things to go wrong, so great caution must be used throughout the process.

The securing ropes or ties are released so that the anchor is ready for deployment, while the vessel continues to motor slowly ahead against the current. This will gradually increase the tension on the rope, which should now all be in the water. As this happens the leading end of the anchor chain is fed over the side, after which the rest will rapidly follow. At this point the skipper may increase the speed of the vessel a little. As the tension increases the rope and chain will exert pressure on the anchor and try to pull it overboard. If the anchor is positioned with its centre of gravity somewhat outboard, this may be all the force needed to tip it over the edge. Otherwise it may be necessary to apply extra force to get the anchor into the water, as described in section 2G.

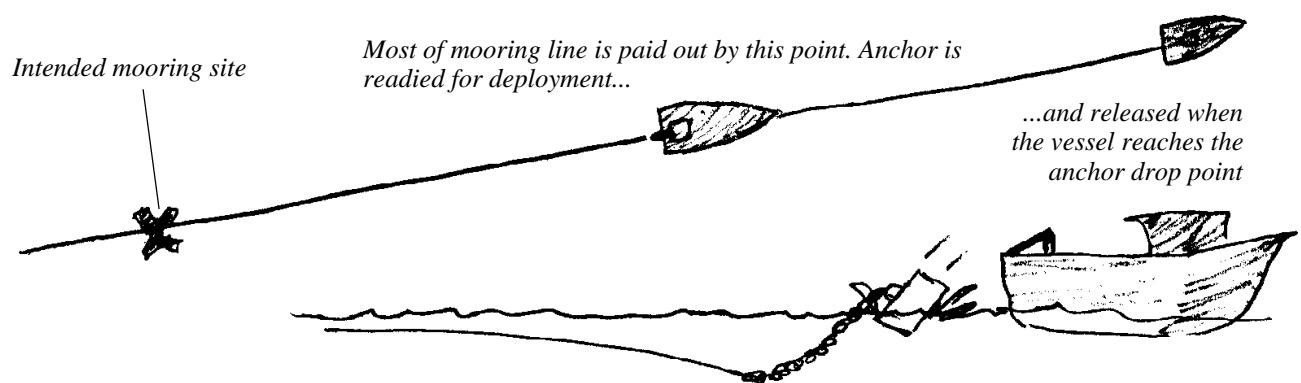

The anchor will quickly sink and as it does so will be progressively pulled away from the deployment vessel as the drag of the mooring pulls it towards the buoy and the designated mooring site (see section 2C).

After deploying the anchor the vessel should clear the area and stay clear until the anchor has hit bottom, the mooring has recoiled, and the buoy has stopped moving. This process generally takes 10 to 15 minutes, but to be sure, a half-hour period should be allowed. Once the buoy is on-station, the vessel should be motored over to the FAD and an inspection made of the buoy and upper mooring (see section 3B) to ensure there has been no damage or tangling of the mooring line.

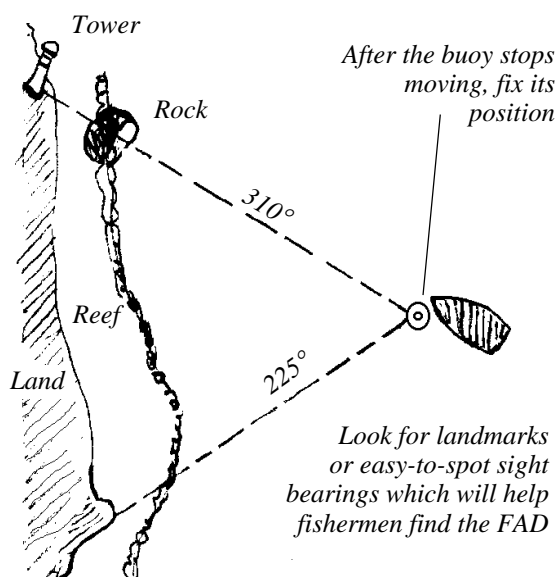

The last job is to make a depth check on the FAD and fix the buoy's position using both shipboard electronics **and** a hand-bearing compass. Accurate position fixes and bearings on prominent landmarks will be needed by fishermen and other users of the FAD (who may not be equipped with GPS) as well as by the personnel who will inspect and maintain it. It is helpful for fishermen to be given the distance and bearing of the FAD from key features such as wharves or reef passages. Visual bearings, where conspicuous landmarks are directly in line with each other, should also be taken so that fishermen without compasses can locate the FAD.

Sight bearings, compass bearings, FAD depth and the distance of the FAD from the shore or nearby fishing ports should be published in local newspapers, on the radio, and in other appropriate forms. The information will not only help fishermen locate the FAD, but will also make other ship traffic aware of its presence.

CHAPTER 3

INSPECTION AND MAINTENANCE

- A. GENERAL INSPECTION**
- B. PHYSICAL INSPECTION**
- C. MAINTENANCE AND REPAIR**
- D. RECORD KEEPING**

INTRODUCTION

This chapter covers activities that should be carried out after deployment to ensure that FADs achieve their maximum life expectancy. Activities include regular checking of FADs above and below the waterline, maintenance of key components, buoy replacement, and the keeping of proper FAD maintenance records.

SECTION 3A: GENERAL INSPECTION

FADs should be inspected and maintained regularly so that problems can be detected or worn components replaced, thus reducing the risk of premature FAD losses. Making regular inspection visits can reveal potential causes of FAD loss before they occur. Regular inspections also increase the chance of pinpointing problems and developing FAD design improvements.

Inspection can be done by almost any vessel, small or large, since all that is required is for one or two personnel to visit the FAD and take a close look at it both above and below the waterline. In the case of maintenance and repair, however, a somewhat larger vessel may be required, as discussed in section 3C.

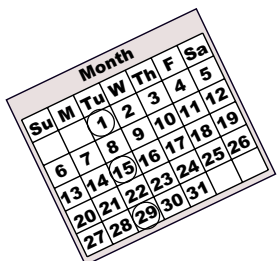

FADs should be inspected regularly, and always after major storms

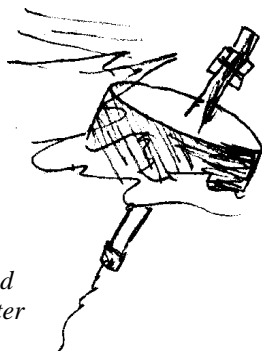

Inspection and maintenance intervals

The time interval between inspections depends to some extent on the remoteness of the FAD mooring sites, and the ease with which they can be accessed. In addition the average life expectancy of the FADs is a factor—if they generally have short life spans they should be inspected more frequently than if they routinely achieve long average life spans. Ideally FADs should be inspected at two-week to one-month intervals whenever practical. In addition, all FADs should be checked as soon as possible after major storms pass through the area, or after long periods of generally heavy seas or stormy weather conditions.

Boat trips carried out with the sole purpose of inspecting FADs can incur significant costs in terms of vessel time, fuel and crew wages. Efficient planning can help keep costs down. Whenever possible inspection and maintenance trips should be scheduled to take place while the vessel is engaged on other projects in the area.

Consulting with fishermen

As well as direct inspection, fishermen provide a valuable source of information since they visit the FAD much more frequently than any inspection team. Contact should be maintained with fishermen using FADs, especially remote ones which may be difficult to inspect regularly, and they should be encouraged to report any problems they observe.



Talk regularly with fishermen and encourage them to report any problems with the FAD

Position checking

During high seas or strong current conditions, forces exerted on the buoy and mooring may create enough tension to drag the anchor or even to momentarily lift it off the seabed. A series of lift-offs and landings will cause the anchor to ‘walk’ along the bottom. If the mooring site is expansive and flat, neither action poses major problems for the FAD. However, if the problem is widespread it may be necessary to increase the mass of future FAD anchors, or to reduce the buoyancy of the existing rafts by substituting smaller buoys. FAD positions should therefore be confirmed on every inspection visit.

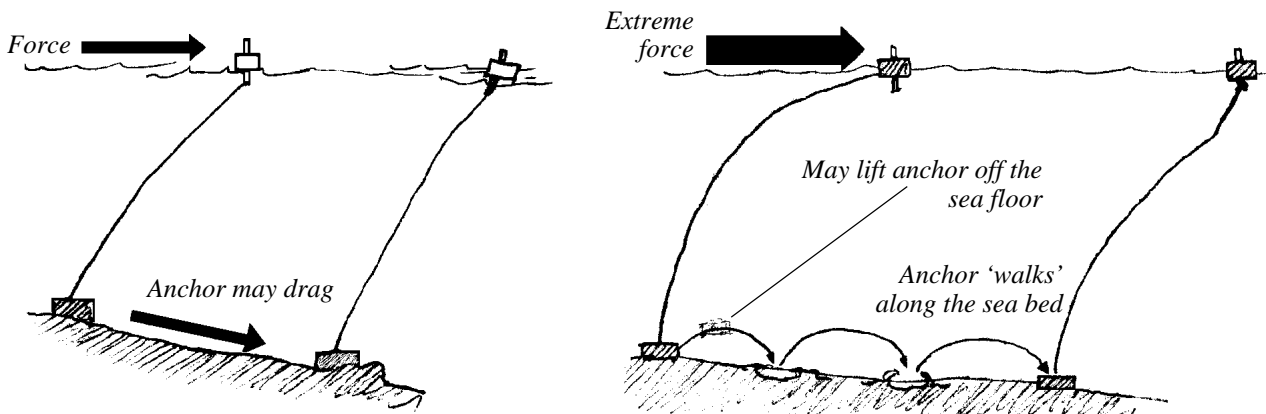

Watch circle

Regardless of the direction and strength of wind and currents, the FAD buoy’s movement will be restricted by the mooring line to a fixed circular area of the sea surface, called the ‘watch circle’. The circle’s centre is positioned directly above the anchor and its radius is the distance from the centre of the circle to the buoy when the mooring is pulled tight by current or weather. At any particular time the FAD buoy may lie at any point within the watch circle, depending on current or weather conditions. The buoy’s watch circle forms the base of an inverted cone, whose vertex, or tip, is at the FAD anchor.

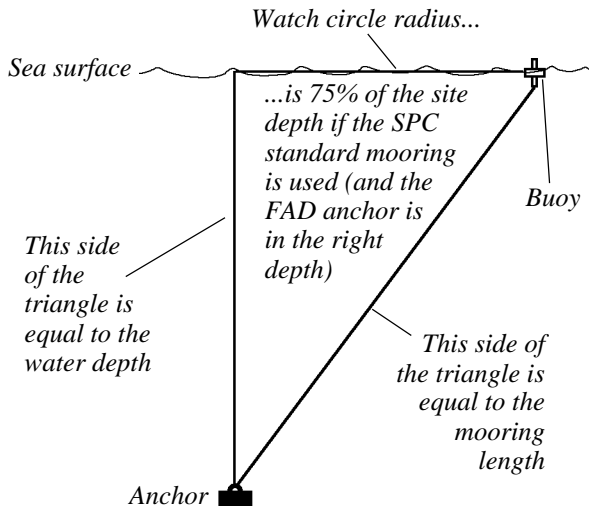
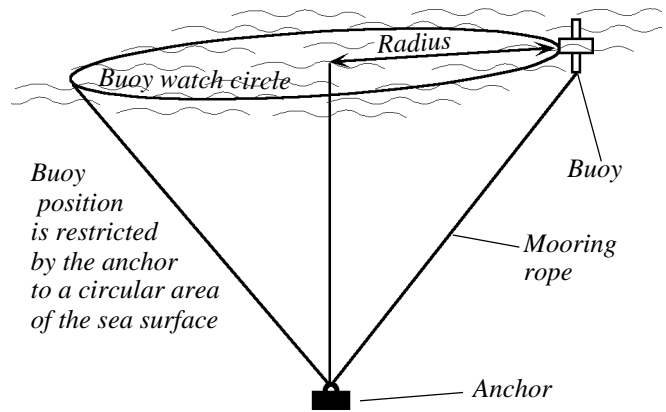

Viewed directly from the side the cone appears as an inverted triangle whose longest side is equal to the length of the FAD mooring and whose height is equal to the water depth. Since both these lengths are already known it is a matter of simple trigonometry to calculate the radius of the watch circle.

In the SPC-recommended mooring system, the length of the mooring is 25 per cent greater than the site depth, as explained in section 2B. As long as this proportion is maintained, and provided that the FAD really is in the right depth, the radius of the watch circle will always be 75 per cent of the site depth. A FAD in 1,200 m of water will have a mooring length of 1,500 m, and the radius of its watch circle will be 900 m.

If some other ratio of mooring length to site depth is used, then the radius of the watch circle can be easily calculated using the formula:

$$r = \sqrt{l^2 - d^2}$$

where **r** is the radius of the circle, **l** is the length of the mooring line and **d** is the site depth.

As an example, take a site where the depth is 1,000 m and the mooring length is 1,150 m (i.e. a mooring length which does not conform to the SPC recommendations). In this case the formula can be worked through as follows:

$$r = \sqrt{(1,150^2 - 1,000^2)} = \sqrt{(1,322,500 - 1,000,000)} = \sqrt{(322,500)} = 568 \text{ m}$$

The radius of the watch circle is thus 568 m. By drawing a circle of this radius around the intended FAD deployment position on the chart, a record can be made of the FAD's watch circle. This should be communicated to fishermen (to help them find the FAD) and to other mariners (to help them avoid it).

As mentioned in previous sections, the anchor rarely lands exactly on the planned FAD site and so its true position and depth are not accurately known. By regularly checking the position of the FAD buoy and plotting the information on a chart, the distribution of the FAD's recorded positions can be gradually built up and the position of the watch circle will gradually become apparent. Plotting the watch circle around the original intended FAD site will allow the true position of the FAD anchor, and thus the accuracy of the FAD deployment, to be determined. Once a series of positions have been accumulated it will also be possible to monitor whether the FAD is dragging.

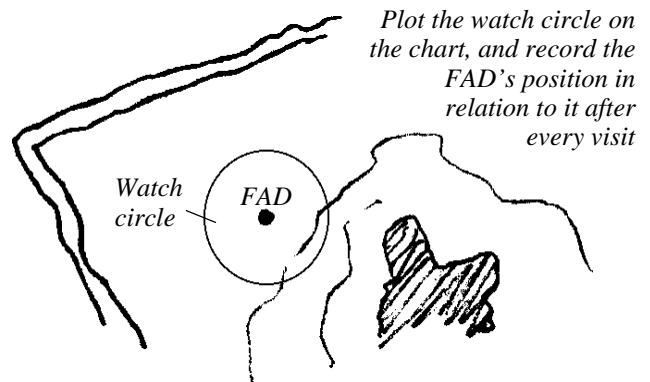

SECTION 3B: PHYSICAL INSPECTION

Physical inspection of the FAD involves examining the various components both above and below the waterline. The surface part of the underwater inspection can be carried out by snorkelling, particularly in calm, clear waters, but SCUBA (self-contained underwater breathing apparatus) is required to inspect the deeper portion of the mooring. When diving is to be carried out the inspection team should always include at least three people: one person who remains on board the inspection vessels, and two snorkellers or SCUBA divers. One member of the team in the water carries out the inspection while the other keeps an eye out for hazards and sharks. **Diving inspections should never be done solo, and SCUBA should only be used by certified, experienced divers.**

Buoy integrity

The general condition of the FAD buoy should be evaluated during each inspection, including paint condition and any signs of corrosion. Welds should be checked closely to make sure that no cracks are developing. Visual detection of small cracks or leaks when they first appear is often difficult but an assessment of how the buoy is riding in the water and the position of the waterline may indicate leakage. Buoys that list in calm seas or ride slightly lower than normal may provide clues that small, hard-to-find leaks have developed.

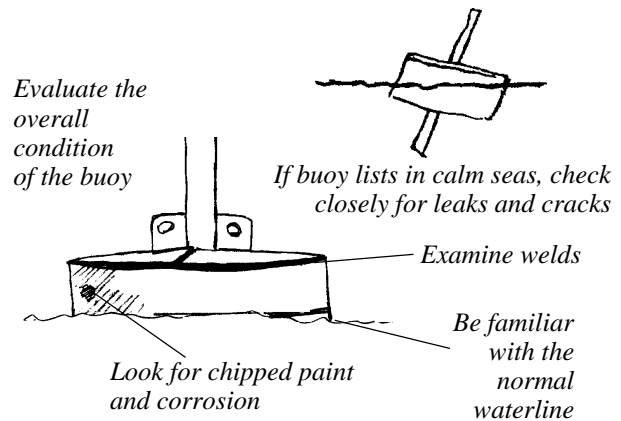

Lights

If the buoy has a light it should be inspected for cracks and checked for moisture inside the unit. Cracked lenses should be replaced or sealed using a bead of clear marine silicone rubber, and any moisture thoroughly dried up.

The light should be checked to make sure it is functioning properly. If the photocell is covered to block out any sunlight, the light should begin flashing as it normally would after dark. All the primary and backup bulbs should be inspected to make sure that none are burnt out, and those which are should be replaced. If the light is powered by a solar panel this should be cleaned and inspected for cracks, which should be sealed with clear silicone rubber.

If a light is not working properly, the simplest thing to do is replace it with a working spare and then fix the problem back on land. The most common problems are low batteries or a bad photocell.

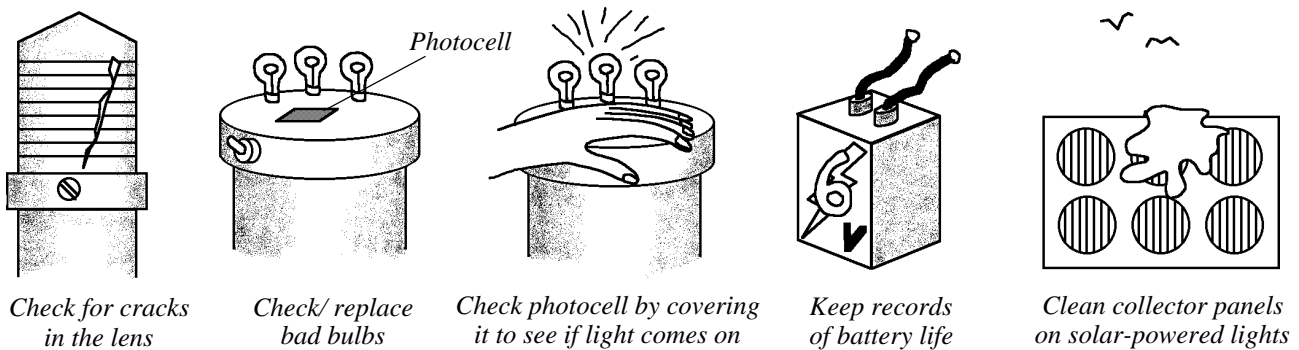

Radar reflector

Plate steel radar reflectors welded directly on the buoy mast are generally trouble-free. About the only exception is when reflector panels are damaged through vandalism. Most often radar reflectors are simply bent out of shape and can be straightened using standard tools. The individual blades should be restored to their right-angled orientation to ensure that the radar reflector provides three planes of reflection as intended.

If buoys are equipped with bolt-on radar reflectors, spare units should be carried on board the inspection vessel. In some areas bolt-on reflectors are popular items for theft.

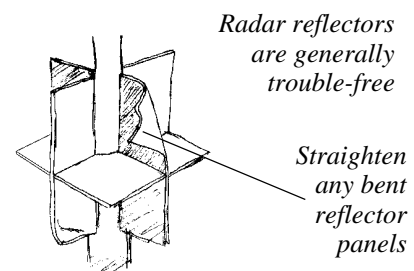

Buoy and mooring attachment

The sub-surface portion of the buoy should be examined (by diving) in the same general manner as for the above-water part. Any areas of corrosion, or places where the paint is chipped away and the bare metal of the buoy is exposed, should be noted.

All the welds should be checked for cracks and stress points, with particular attention being paid to the welds that join the mooring attachment point to the buoy hull, an area which is subject to high stress. If the buoy is listing or riding lower in the water than usual, special care should be taken when checking for cracks or leaks.

If sacrificial anodes are fitted to the buoy, their condition should also be checked.

Upper chain and hardware

The general condition of the upper chain, as well as the connecting hardware that joins it to the buoy, should be checked to assess the degree of wear and general corrosion of the components. If certain components exhibit specific wear points, or appear to be wearing faster in certain places, this should be noted.

All the safety shackles should be checked to ensure that they have remained tightly closed. Each nut and bolt pin should be closely inspected. The shackles that form the connection between the buoy and the mooring should be given special attention as the constant motion of the buoy makes these shackles particularly susceptible to wear.

All the swivels should be checked to ensure that they rotate freely and do not bind. Any growth on the swivels should be chipped off and any fishing line snagged or tangled on the mooring should be cut away to avoid fouling of the swivels.

Chain-mooring rope connection

The hardware that connects the upper chain to the mooring rope should be inspected in a similar way to the buoy connection. Hardware components should be checked to make sure they are not binding or wearing unevenly, and swivels should be worked by hand to ensure that they rotate easily.

The rope connector should be checked for cracks and wear. It is particularly important to ensure that no rope is in direct contact with any chain or hardware.

The eye splice should be examined to make sure that it has not slipped. The taped ends of each spliced strand should still be protruding at least 25 mm outside the body of the rope.

To complete the inspection the divers should descend briefly to the 30 m depth, checking the mooring rope for signs of abrasion or cut strands along its length. Once at 30 m they should hang there momentarily before re-ascending to look for any signs of abrasion or cut strands as far as can be seen down the main mooring rope. In clear ocean water where visibility is good, it may be possible to visually check another 50 m or so of the rope in this way.

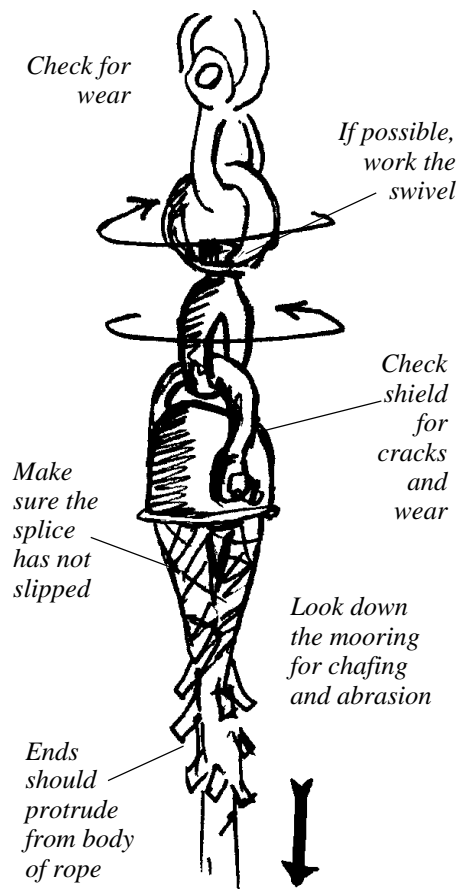
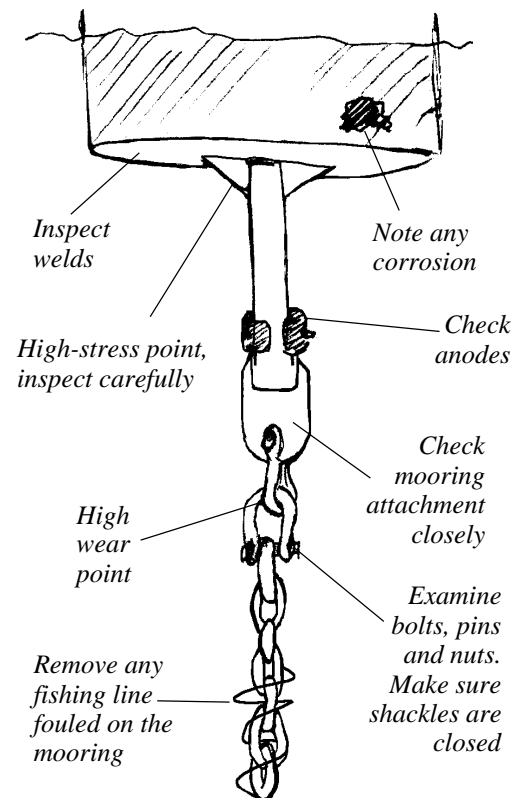

And remember: diving on FADs is a dangerous activity which should only be done by certified, experienced divers.

SECTION 3C: MAINTENANCE AND REPAIR

Many FAD losses occur as a result of damage to the FAD buoy, or to mooring failure within 30 m of the surface. The most extreme forces exerted on the buoy and mooring occur within this relatively narrow surface layer. Routine visual inspections and maintenance have the potential to prevent many buoy and shallow-water mooring failures.

Like any other task that involves mechanical equipment, FAD maintenance requires careful planning and a coordinated effort. Conscientious, skilled personnel who take the necessary precautions and use the proper equipment can carry out FAD maintenance safely and effectively.

Maintenance situations

Visual inspection, as described in section 3B, may reveal a number of situations that require maintenance. The most common are a leaking or partially flooded buoy, a mooring connection which has partially separated from the buoy, badly corroded or worn hardware components, and abraded or partially severed mooring rope.

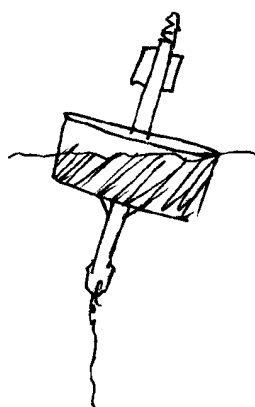

Leaky or partially flooded buoy



Broken stirrup on raft



Badly worn hardware components



Partially cut mooring rope

General procedures

If the damage is to the mooring rope then it will be necessary to haul up the rope and repair it at sea by cutting out the damaged part and splicing in a new section. If the FAD raft or upper chain and hardware are damaged, the best approach is to replace the entire unit with a new one and then bring the damaged unit back to shore for a more thorough inspection and repair. In fact routine buoy replacement every six months or so is an appropriate maintenance strategy to minimise the risk of FAD loss.

In either case, while large vessels equipped with heavy lifting gear make the job easier, the work can also be done using smaller vessels, if necessary using towing bridles to transport the FAD buoys as shown in section 2H.

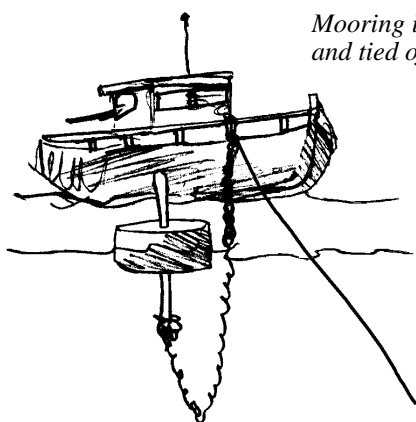

Mooring is hauled up and tied off on the vessel

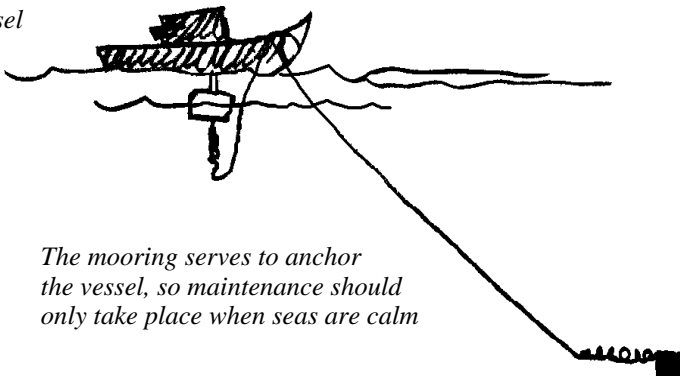

The mooring serves to anchor the vessel, so maintenance should only take place when seas are calm

While performing maintenance the vessel uses the FAD mooring as an anchor line. Maintenance operations should only be carried out during calm seas, when the risk of the vessel dragging the FAD anchor is least.

There are three principal approaches to buoy replacement or mooring-line repair.

Hauling out the buoy

If the maintenance vessel is equipped with a boom and heavy lifting gear then the entire buoy and upper hardware can simply be lifted aboard the maintenance vessel. The repairs can then be carried out or a new buoy attached and put back into the water.

Hauling out the upper hardware

If the maintenance vessel does not have heavy lifting gear, it should still be possible to haul the upper hardware aboard using the vessel's anchor winch, on-board hydraulics, block-and-tackle or chain hoists, or the simple brute force of the crew. To allow hauling of this gear, divers will first need to enter the water to attach the hauling lines to appropriate points on the mooring rope. Normally this simply involves attaching the end of the hauling line to the hardware at the bottom end of the upper chain, which should be at a depth of about 15 m. Hauling the mooring from this point minimises the amount of weight that needs to be lifted.

Once this part of the mooring is on the boat then the mooring rope can be progressively hauled aboard until the damaged part is reached and can be repaired. Alternatively, if the buoy and/or upper hardware are to be swapped, then the old components can be disconnected and the new ones attached, with the work being carried out on deck. If necessary both buoys can remain in the water during this manoeuvre, held under control at a suitable place by tag-lines and fenders.

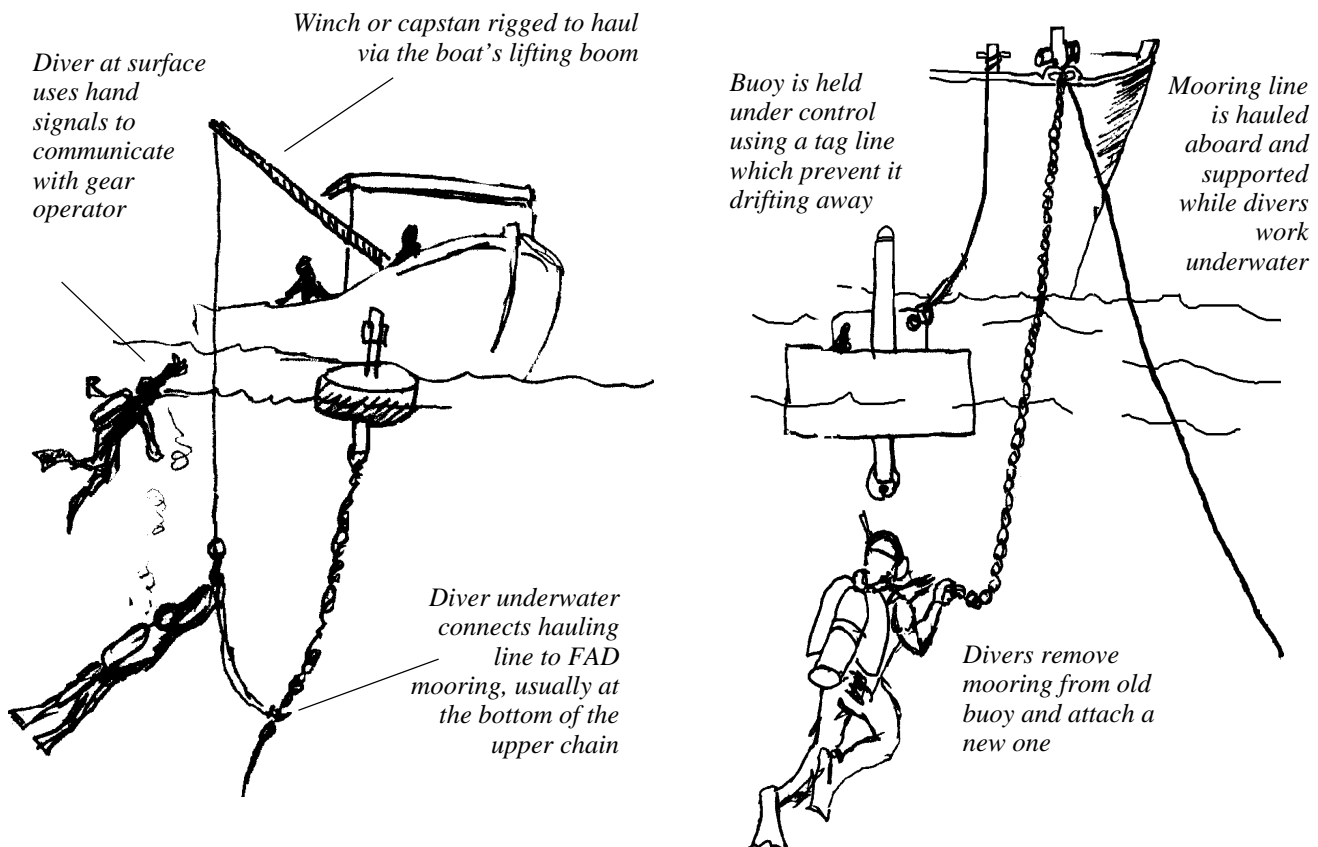

Underwater buoy swapping

If for some reason the mooring cannot be hauled aboard the maintenance vessel then it will not be possible to carry out repairs to the mooring line itself, since the depth and time required make it impossible for this work to be done by divers. However the swapping of buoys can be done underwater, provided that the sea is extremely calm. In this case the divers should attach two lines from the vessel to the FAD mooring—one to the top end of the upper chain, and the other to the mooring rope. The mooring can then be disconnected and the old buoy tied off astern, out of the way while the mooring line itself is left suspended below the vessel. The vessel crew use the hauling line to manoeuvre the upper chain into place close to the new buoy, where the divers can then attach it by reversing the disconnection procedure.

SECTION 3D: RECORD KEEPING

Clear, careful inspection and maintenance records should be kept for every FAD, with notes being taken after each visit or intervention. Records should include the date of the visit, names of personnel who carried out the inspection or performed any maintenance, exactly what inspections or maintenance took place, notes on the general condition of the FAD, and specific references to any component or section of the buoy or mooring which may require attention in the near future. Information on the duration and frequency of replacement of light batteries should be noted, and diagrams should be used to describe the location of any areas where problems seem to be developing. These might include such thing as spots where the paint has chipped off down to the bare metal of the buoy. Good diagrams and descriptions are especially important if inspections are not always carried out by the same individuals. Records should be filed in chronological order, and should be consulted prior to a maintenance visit.

An example of a FAD inspection and maintenance form is illustrated below.

FAD: AA (Rocky Point FAD)		
Date: 11 October 1993	Personnel: R. Borja, S. Fusimalu, T. Vanualevu	
Position: 12°18' N and 145°55' E	Date Deployed: 6 March 1993	Current Status: On-Station
INSPECTION		
Item	Inspected	Comments
Above Water: Buoy	Y	No leaks, paint chipped off near waterline
Light	Y	Changed batteries. Last pack only lasted 2 months!
Radar Reflector	Y	No problems
Below Water Buoy	Y	Overall condition good. Should replace anodes on next visit.
Mooring Attachment	Y	Mooring attachment good.
Chain/ Connecting Hardware	Y	Only general corrosion. No uneven wear.
Chain/ Rope Connection	Y	Small chafe on line 4 metres below connector
MAINTENANCE		
Only battery pack replacement for light this time. Short life time for last batteries. Usually last 9 months. Check batteries carefully on all FADs next inspection. Short battery life could be because we changed to a different brand.		
GENERAL COMMENTS		
<p>FAD buoy and upper mooring in good condition. No serious corrosion or apparent leaks. Keep an eye on a paint chip near the waterline just below one of the lifting eyes (see diagram).</p> <p>Welds look good, holding up much better than welds on previous buoys built by Ace Welding. Must replace both anodes on next visit. Keep an eye on the small cut in the mooring line. Looks like it was caused by fishing hook. Could require maintenance in the future.</p> <p>FAD on-station about 7 months now.</p> <p>Next inspection should be 15 Nov. Can inspect all 4 FADs on the south side on that same trip.</p>		

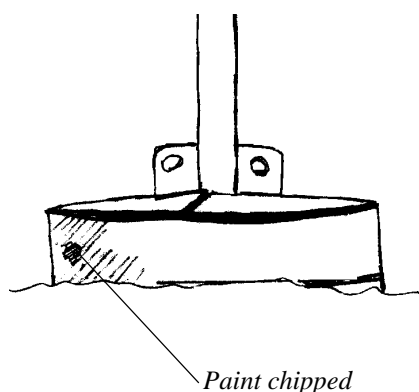

Records should be detailed enough so that anyone can understand them, a consideration which is especially important in case of personnel turnover. If proper records are not kept, then when an officer responsible for FAD maintenance quits or is transferred, all the information will leave with him and new staff will not know the status of any of the FADs.

The process of carrying out FAD surveys, deploying the FADs, and maintaining them after deployment is more complex than many people imagine. A non-systematic, even lackadaisical approach to many FAD programmes in the past has led to high loss rates, wasted money, and a general disillusionment about FADs, which are then perceived to cost more than they bring in benefits. This perception has especially affected many agencies which have traditionally provided funding for FADs. Such agencies frequently feel that their money is simply being thrown into the sea, as they finance one quickly-lost FAD after another.

In fact this need not be the case. A proper approach to planning, evaluation and monitoring will identify opportunities in which FADs can be a cost-effective fisheries development tool. Considered design based on sound engineering principles and competent construction by skilled technicians will ensure that FADs are robust and long-lasting. Thorough site surveys, careful deployment following basic maritime rules and practices, and scheduled follow-up inspection and maintenance will ensure that when FADs are put in the water their chances of staying there are maximised.

The other major area of neglect in regard to FAD programmes has been, and continues to be, that of data collection. Few of the fisheries development agencies in the region take the trouble to monitor the effectiveness of the FADs they deploy, in terms of the additional fish production, better vessel operating economics or improved safety they may engender. Without data on FAD performance it is very hard to demonstrate the effects—positive or negative—of the FAD programme and even harder to convince those holding the purse-strings as to why they should continue to finance further deployments.

The three volumes of the SPC *Fish Aggregating Device Manual* have dealt with all these areas. The present volume, covering site survey, deployment, and follow-up inspection and maintenance, concludes the series by completing the information needed to ensure a FAD programme functions with maximum returns to the programme beneficiaries. FAD programmes which follow the recommendations in the three volumes of the SPC FAD manual will have the greatest chance of providing real, long-lasting benefits to fishermen and fish consumers in Pacific Island countries and territories.

*Secretariat of the Pacific Community
Coastal Fisheries Programme – Capture Section
B.P. D5, 98848 Noumea Cedex
New Caledonia*

Phone: +687 262000

Fax: +687 263818

E-mail: Capture@spc.org.nc